

CATALOGUE

**TUNABLE WHITE/HCL
LIGHTING SYSTEMS**

Beghelli

HCL HUMAN CENTRIC LIGHTING

Daylight, a natural regulator of our organism



Thanks to evolution, our lives and our activities are driven by the natural day-night cycle. Throughout the day, when plenty of natural light is available, we are active and perform all our activities, such as school, work, hobbies and entertainment. The evening is a period when the light fades and gradually weakens. With darkness comes the time for a needed rest.

Our everyday cycle developed as an adaptation to the environment that surrounds us. Scientific research has confirmed that compliance with the natural day-night cycle is not only a practical thing but it is also deeply rooted in our nature. Type of light affects the human organism, the production of vitamins and production of melatonin that regulates sleep, therefore has a direct impact on mood and health of our bodies.

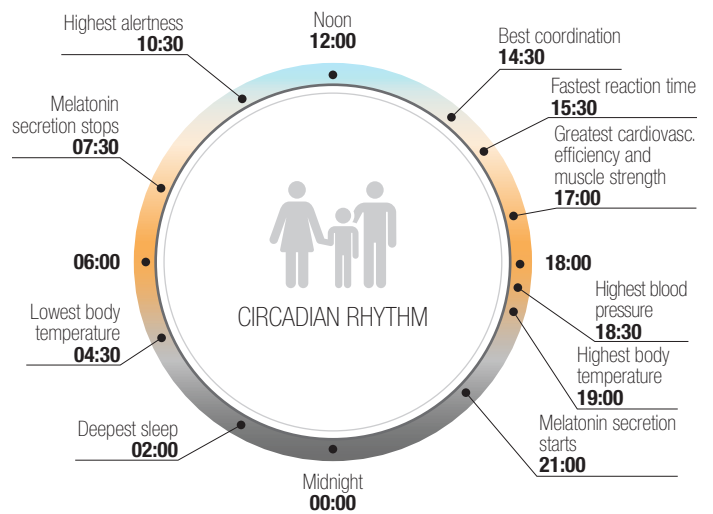

The principle of HCL is to imitate the natural daylight in the interior with the use of artificial luminaires.



About **80% of our sensory impressions are registered through our eyes.** And it is a quality of light that determines how well we see and perceive our surrounding. Lighting type has a key impact on our eyesight and it directly affects our **mental and physical well-being.**

Natural daylight changes dynamically throughout the day in terms of intensity and colour temperature. And this has a direct impact on our biological rhythm which is called the Circadian cycle, that controls human biological clocks. For its proper functioning and thus our health it is necessary to follow the preset cycles of the human

body. **The colour temperature of natural light develops** from 1 900 K (at sunrise) to 7 000 K (at noon) during the day. In the evening, it gradually decreases to the value around 2 700 K. It is a signal for the human organism to prepare for sleep.

90%
Average we spend up to 90% of our time indoors. In winter it is sometimes even more. All day, from morning to evening, artificial light is still the same with no changes.

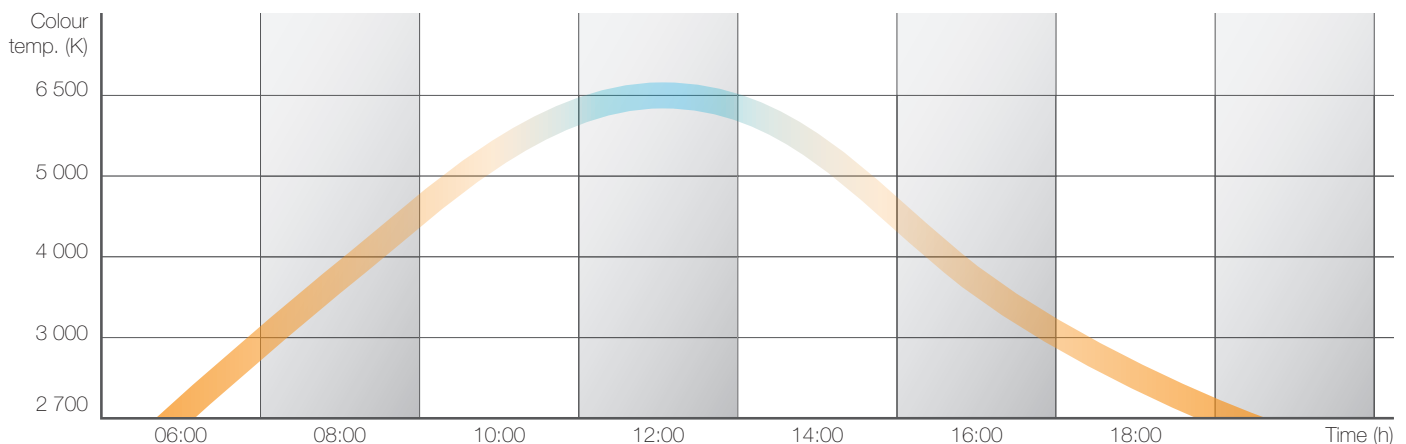

Natural lighting is dynamic it is changing constantly throughout the day from sunrise to sunset. The change is not just in the value of colour temperature but also in colour itself and intensity.

Human Centric Lighting – HCL

Pluses and uses of the Human Centric Lighting

Mainly suitable for areas where people spend much of their daytime:

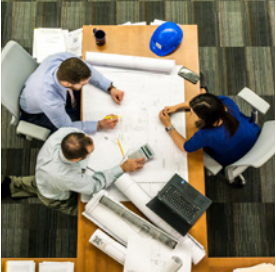

Workspaces Offices

Performance improvement



Hospital

Impact on the psychological condition, faster healing



Educational institutions

Higher concentration, better learning ability

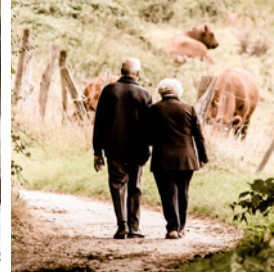

Retirement homes

Better mood, impact on daily rhythm, activity



Homes

Better sleep, relaxation, well-being

Still more and more scientific researches confirm the influence of light on different aspects of human life. Light intensity and light spectrum play an important role in the proper functioning of the human body, not only in physical but also in a mental way. This is particularly important for areas where **high mental performance is required**.

Luminaires with Human Centric Lighting fit perfectly into offices and classrooms, where their potential can be fully exploited due to their **impact on work efficiency and learning**.

At the same time, the quality of light has an effect on the elimination of current tiredness and guarantees visual comfort. These are the basis for increasing the vigilance and vitality of employees. That is very important in the working environment.

However, the greatest benefits of HCL are evident in the health care sector. Patients are often under the influence of artificial light in the interior for longer periods of time, it is always without the possibility of change. Ensuring a natural Circadian rhythm is important not only for the **well-being of patients but also for their faster treatment**.

Human Centric Lighting technology, also known as biodynamic lighting, was previously used very little due to its high initial and operating costs. Thanks Beghelli, HCL technology is now available to everyone who expects countless colour temperatures and light intensity variations that mimic natural daylight.

MAIN ADVANTAGES

- 1 Synchronization with the natural rhythm**
Correct lighting helps a human body synchronize with the "natural day-night rhythm". It is healthier for the biological system and it is important for the proper production of melatonin that is crucial for good sleep.
- 2 Concentration increase**
Proper lighting keeps us alert and efficient throughout the whole day.
- 3 Health and well-being**
Light has a key influence on our sight and it directly affects our mental and physical well-being and the health of the whole organism.

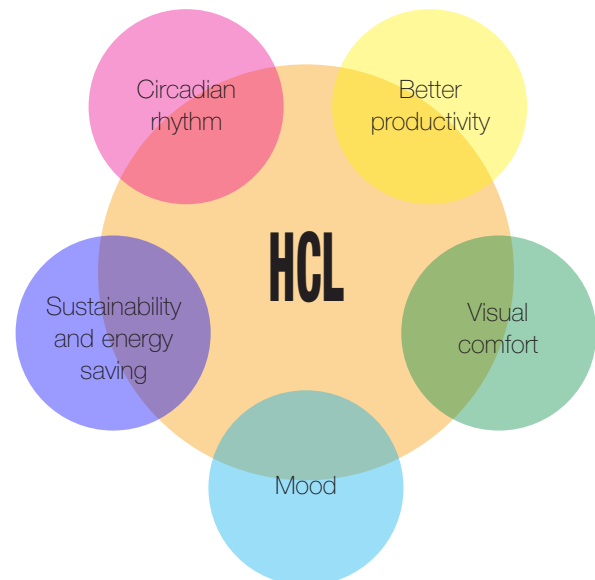

Solution that meets all individual requirements and is suitable for each installation size

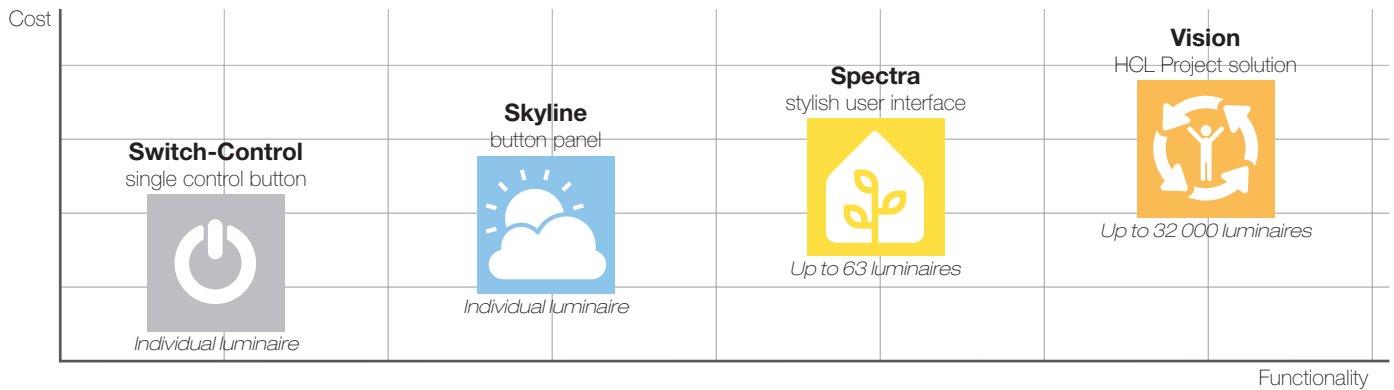

1. Switch-Control – single control button



Advantages:

- No additional components needed
- No complicated programming or system setup requirements
- Cheapest solution for Tunable White control

Description

- Solution just for one luminaire
- Only basic functions – colour & intensity adjustment
- Preset can only be set externally via PC

2. Skyline – button panel



Advantages:

- Solution includes 4 preset Tunable White scenes simulating different weather conditions
- No complicated programming or system setup requirements

Description

- Solution just for one luminaire
- When using multiple luminaires in random mode, each shines in a different colour
- Additional components needed

- Simulation of natural lighting changes with light intensity and temperature adjustment
- Just for one luminaire/driver
- No complicated system setup needed, it works instantly after installation



Skyline panel

Icon	Effect	Activity – When to use	Colour Temperature	Light Output
	Calm down	High stress period	Warm white	80%
	Energise	Early morning – awakening	Cool white	100%
	Concentrating	Thinking process Presentations	Intermediate temperature	50%
	Stay alert	Normal daily work	Changing naturally	90%

Tunable White – 4 different solutions

3. Spectra – stylish user interface



Advantages:

- Intuitive setting of Tunable White luminaires right on the wall
- Solution for up to 63 luminaires Tunable White
- Perfect design into a normal installation box
- 4 scenes with a possibility of direct adjustment by the user
- Manual colour temperature and light intensity correction
- Bluetooth – control via smartphone/tablet
- App for iOS and Android for free

Description

- Additional components needed

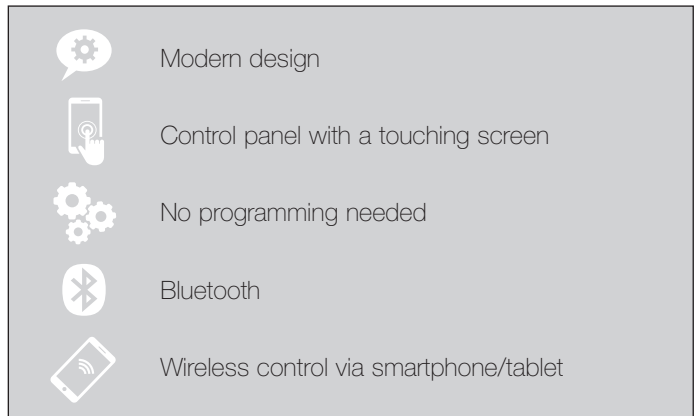

Spectra panel – different material and colour variations

4. Vision – HCL Project solution



Advantages:

- Any control options – buttons, touch panels, wireless access, schedules
- Possibility to control any number of luminaires in one system (max. 32 000)
- Possibility to set individual daily plan (according to an individual circadian rhythm of a person)
- Matching the colour temperature to the time of a day and season
- Overview of the status, consumption and failures of individual luminaires
- Customized graphical applications
- Possibility of regulation of lighting intensity according to daily contributions of light
- App for iOS and Android for free

Description

- Additional components needed
- System specification and configuration must be always tailored

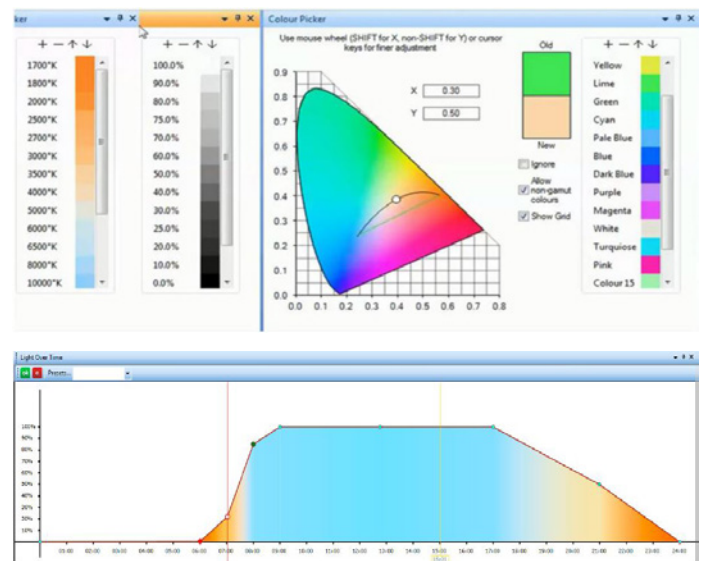

Unlimited possibilities according to customer requirements

Following luminaires support all four solutions (Switch-control, Skyline, Spectra and Vision).

Atomic TOP LED HCL 1,2m

Ceiling and suspended LED luminaire

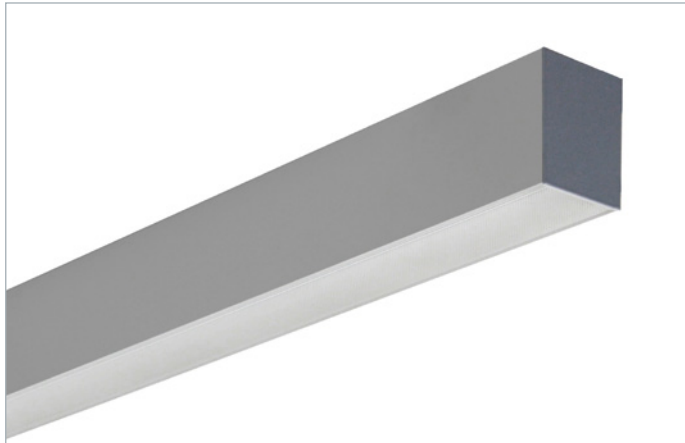

GENERAL CHARACTERISTICS

Power supply 198–264 VAC, 176–280 VDC

Standard EN 60598-1, EN 60598-2-1, EN 60598-2-22 (fundamental requirements), EN62471 (Photobiological hazard)

Protection grade IP40, IK05

Working temp. -20 ÷ +40°C

Mounting ceiling, suspended mounting

Body anodized aluminium profile with steel endings in grey

Screen microprismatic or opal optics

Driver DALI LED driver for Tunable White

Control gear 100 000 h

Lifetime**

Luminous flux > 80 000 (L80B20)

maintenance**

Colour deviation 3 SDCM

Colour Temp. 2 700–6 500 K

** At a reference working temperature of 25°C

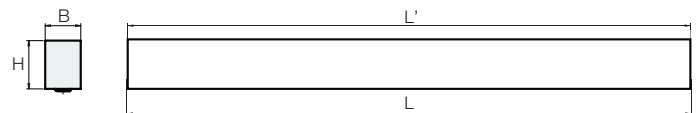

Length "L" including endings
Length "L'" profile without endings

• Dimensions (mm) •				Weight kg
L	B	H	L'	
1137	60	81,5	1134	2,6

Accessories

to be ordered separately

Order code	Description
99-0275	WIRE SUSPENSION, 1 pc, 200 cm (for one luminaire 2 pcs needed)
99-0095	TRANSPARENT POWER CABLE 200 cm (5x 1.5 mm ²)



Human Centric Lighting (HCL)

The effects of lighting on the biological rhythm of the human body have a direct impact on comfort, productivity and health in indoor environments. The model that should be followed is that dictated by nature with regard to light intensity, colour and direction, in harmony with our internal biological clock.

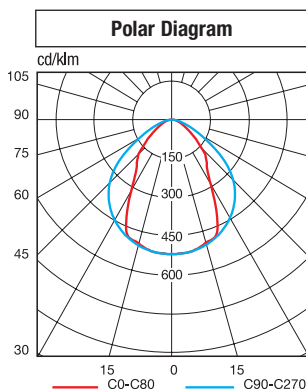

Atomic TOP LED Human Centric Lighting (HCL)



Order code	Description	LED Power W	Colour Temp. K	Colour rendering	Power consumption Max W	N° LEDs	Flux of LEDs lm (Tj=25°C)	Flux of fixture lm	Luminous efficiency lm/W	Energy Class	Packaging
T03-10140HW	Atomic TOP LED 2700–6500K 1,2m	17	4000	>80	20	64	2400	1900	95	A+	1
T03-10140HZ	Atomic TOP LED 2700–6500K 1,2m	17	4000	>80	20	64	2400	1700	85	A+	1
T03-10141HW	Atomic TOP LED 2700–6500K 1,2m	30	4000	>80	34	128	4700	3100	91	A+	1
T03-10141HZ	Atomic TOP LED 2700–6500K 1,2m	30	4000	>80	34	128	4700	2700	79	A+	1

R_a>90 on request, Z – opal cover, W – microprismatic cover



Atomic TOP LED HCL 1,2m

Recessed LED luminaire

Atomic TOP LED is a luminaire of a new generation characterized by a very good lighting efficiency, which ensures the high comfort of illumination. Housing is made of anodized aluminium profile with steel endings. The luminaire is equipped with a microprismatic diffuser ensures very high efficiency. It provides a very good visual comfort with no glare. It fits perfectly in offices, conference and training rooms, lecture halls as well as exhibition spaces and showrooms.

HCL version with biodynamic colour temperature offers the possibility to select the required colour temperature (from 2700K to 6500K). Human Centric Lighting luminaires perfectly fit in offices and classrooms due to its influence on efficiency and learning ability. But the greatest benefits are mainly seen in healthcare, where the natural day rhythm is important for well-being and faster healing.

GENERAL CHARACTERISTICS

Power supply 198–264 VAC, 176–280 VDC

Standard EN 60598-1, EN 60598-2-1, EN 60598-2-22 (fundamental requirements), EN62471 (Photobiological hazard)

Protection grade IP40, IK05

Working temp. -20 ÷ +40°C

Mounting recessed mounting in plaster ceilings

Body anodized aluminium profile with steel endings in grey

Screen microprismatic or opal optics

Driver DALI LED driver for Tunable White

Control gear 100 000 h

Lifetime**

Luminous flux maintenance** > 80 000 (L80B20)

Colour deviation 3 SDCM

Colour Temp. 2 700–6 500 K

** At a reference working temperature of 25°C

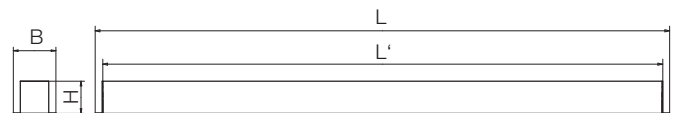

Length "L" including endings
Length "L'" profile without endings
Recess hole 65 mm × 1142 mm

• Dimensions (mm) •				Weight
L	B	H	L'	kg
1154	77	81,5	1134	2,6

Polar Diagram

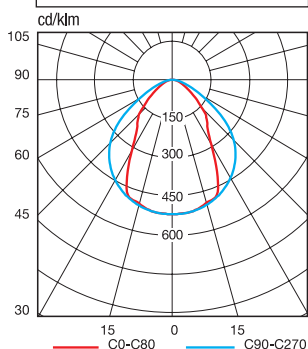

Human Centric Lighting (HCL)

The effects of lighting on the biological rhythm of the human body have a direct impact on comfort, productivity and health in indoor environments. The model that should be followed is that dictated by nature with regard to light intensity, colour and direction, in harmony with our internal biological clock.

Atomic TOP LED Human Centric Lighting (HCL)



Order code	Description	LED Power W	Colour Temp. K	Colour rendering	Power consumption Max W	N° LEDs	Flux of LEDs lm (Tj=25°C)	Flux of fixture lm	Luminous efficiency lm/W	Energy Class	Packaging
T03-10R40HW	Atomic TOP LED 2700–6500K 1,2m	17	4000	>80	20	64	2400	1900	95	A+	1
T03-10R40HZ	Atomic TOP LED 2700–6500K 1,2m	17	4000	>80	20	64	2400	1700	85	A+	1
T03-10R41HW	Atomic TOP LED 2700–6500K 1,2m	30	4000	>80	34	128	4700	3100	91	A+	1
T03-10R41HZ	Atomic TOP LED 2700–6500K 1,2m	30	4000	>80	34	128	4700	2700	79	A+	1

R_a>90 on request, Z – opal cover, W – microprismatic cover

Arietis LED HCL

Recessed LED luminaire IP65



Arietis LED is a luminaire for universal mounting into ceiling modules M600, M625 and plaster ceilings. It fits perfectly in hospitals, laboratories, precincts with high humidity and dustiness, precincts demanding high sanitary codes, operating theaters.

HCL version with biodynamic colour temperature offers the possibility to select the required colour temperature (from 2700K to 6500K). Human Centric Lighting luminaires perfectly fit in offices and classrooms due to its influence on efficiency and learning ability. But the greatest benefits are mainly seen in healthcare, where the natural day rhythm is important for well-being and faster healing.

GENERAL CHARACTERISTICS

Power supply 198–264 VAC, 176–280 VDC

Standard EN 60598-1, EN 60598-2-1, EN 60598-2-22 (fundamental requirements), EN62471 (Photobiological hazard)

Protection grade IP65

Working temp. -20 ÷ +40°C

Mounting universal mounting into ceiling modules M600, M625 and plaster ceilings

Body steel sheet finished by powder technology varnishing, white RAL 9003

Screen microprismatic optics

Driver DALI LED driver for Tunable White

Control gear Lifetime** 100 000 h

Luminous flux maintenance** > 80 000 (L80B20)

Colour deviation 3 SDCM

Colour Temp. 2 700–6 500 K

** At a reference working temperature of 25°C

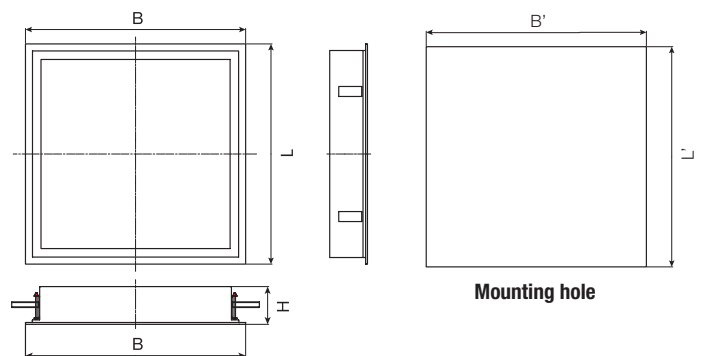

Version	• Dimensions (mm) •					Weight max kg
	L	B	H	L'	B'	
M600	595	595	102	565	565	4,5
M625	622	622	102	592	592	5,0

Accessories

supplied

Order code	Description
-	HOLDERS

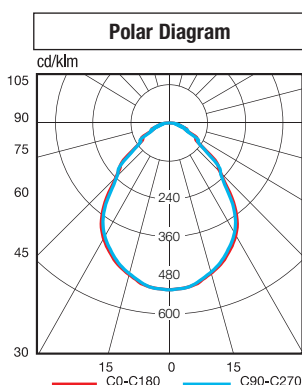

Human Centric Lighting (HCL)

The effects of lighting on the biological rhythm of the human body have a direct impact on comfort, productivity and health in indoor environments. The model that should be followed is that dictated by nature with regard to light intensity, colour and direction, in harmony with our internal biological clock.

Arietis LED Human Centric Lighting (HCL)



Order code	Description	LED Power W	Colour Temp. K	Colour rendering	Power consumption Max W	N° LEDs	Flux of LEDs lm (Tj=25°C)	Flux of fixture lm	Luminous efficiency lm/W	Energy Class	Packaging
T02-10120HW	Arietis LED 2700–6500K M600	43	4000	>80	48	264	7000	5000	104	A+	1
T02-10125HW	Arietis LED 2700–6500K M625	43	4000	>80	48	264	7000	5000	104	A+	1

R_a>90 on request

Salemo LED HCL

Recessed LED luminaire



GENERAL CHARACTERISTICS

- Power supply** 198–264 VAC, 176–280 VDC
- Standard** EN 60598-1, EN 60598-2-1, EN 60598-2-22 (fundamental requirements), EN62471 (Photobiological hazard)
- Protection grade** IP40/20
- Working temp.** -20 ÷ +40°C
- Mounting** mounting into ceiling modules M600, M625 – inlay mounting
- Body** steel sheet finished by powder technology varnishing, white RAL 9003
- Screen** opal diffuser
- Driver** DALI LED driver for Tunable White
- Control gear** 100 000 h
- Lifetime****
- Luminous flux maintenance**** > 80 000 (L80B20)
- Colour deviation** 3 SDCM
- Colour Temp.** 2 700–6 500 K

** At a reference working temperature of 25°C

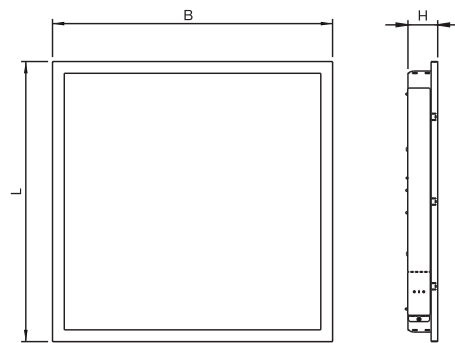

Version	• Dimensions (mm) •			Weight max kg
	L	B	H	
M600	595	595	63	4,8
M625	620	620	63	5,0



Human Centric Lighting (HCL)

The effects of lighting on the biological rhythm of the human body have a direct impact on comfort, productivity and health in indoor environments. The model that should be followed is that dictated by nature with regard to light intensity, colour and direction, in harmony with our internal biological clock.

MOUNTING INTO CEILING MODULE M600 AND M625

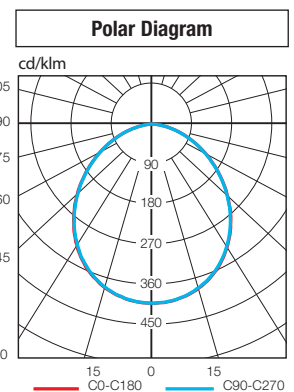
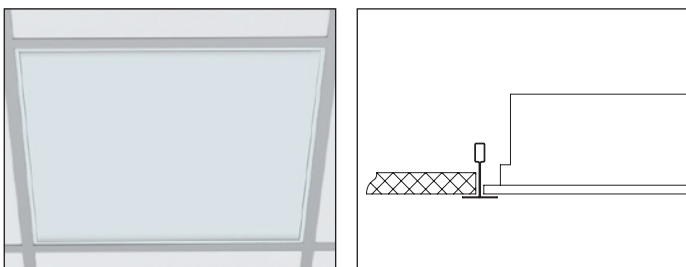

Salemo LED Human Centric Lighting (HCL)



Order code	Description	LED Power W	Colour Temp. K	Colour rendering	Power consumption Max W	N° LEDs	Flux of LEDs lm (Tj=25°C)	Flux of fixture lm	Luminous efficiency lm/W	Energy Class	Packaging
T01-10100HM	Salemo LED 2700–6500K M600	43	4000	>80	48	264	7000	5800	121	A+	1
T01-10105HM	Salemo LED 2700–6500K M625	43	4000	>80	48	264	7000	5800	121	A+	1

R_a>90 on request

Lyra LED HCL

Recessed LED luminaire



Lyra LED is a luminaire for mounting in ceiling module M600, M625 and plaster ceilings. Its body is made of steel sheet finished by powder technology varnishing, colour white RAL 9003, with diffuser with microprismatic optics. The degree of protection is IP20. It fits perfectly in computer labs, large and small offices and lecture halls.

HCL version with biodynamic colour temperature offers the possibility to select the required colour temperature (from 2700K to 6500K). Human Centric Lighting luminaires perfectly fit in offices and classrooms due to its influence on efficiency and learning ability. But the greatest benefits are mainly seen in healthcare, where the natural day rhythm is important for well-being and faster healing.

GENERAL CHARACTERISTICS

Power supply 198–264 VAC, 176–280 VDC

Standard EN 60598-1, EN 60598-2-1, EN 60598-2-22 (fundamental requirements), EN62471 (Photobiological hazard)

Protection grade IP20

Working temp. -20 ÷ +40°C

Mounting universal mounting into ceiling modules M600, M625 and plaster ceilings

Body steel sheet finished by powder technology varnishing, white RAL 9003

Screen microprismatic optics

Driver DALI LED driver for Tunable White

Control gear Lifetime** 100 000 h

Luminous flux maintenance** > 80 000 (L80B20)

Colour deviation 3 SDCM

Colour Temp. 2 700–6 500 K

** At a reference working temperature of 25°C

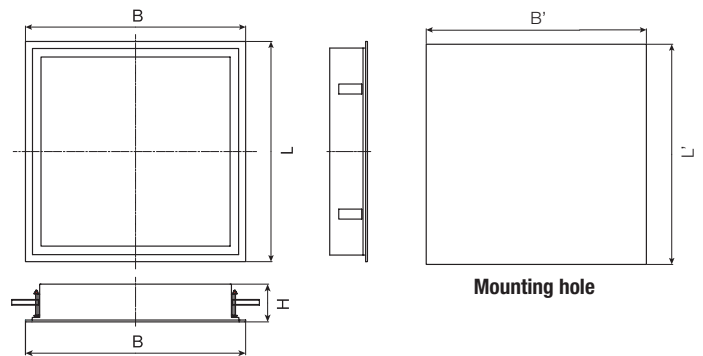

Version	• Dimensions (mm) •					Weight max kg
	L	B	H	L'	B'	
M600	595	595	60	575	575	5,0
M625	620	620	60	600	600	5,0

Accessories

supplied

Order code	Description
99-298	STEEL HOLDERS (4pcs)

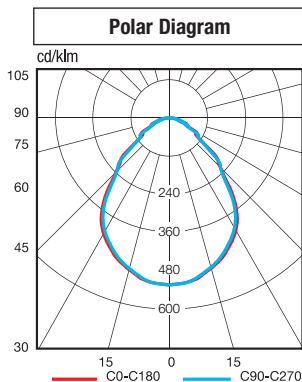

Human Centric Lighting (HCL)

The effects of lighting on the biological rhythm of the human body have a direct impact on comfort, productivity and health in indoor environments. The model that should be followed is that dictated by nature with regard to light intensity, colour and direction, in harmony with our internal biological clock.

Lyra LED Human Centric Lighting (HCL)



Order code	Description	LED Power W	Colour Temp. K	Colour rendering	Power consumption Max W	N° LEDs	Flux of LEDs lm (Tj=25°C)	Flux of fixture lm	Luminous efficiency lm/W	Energy Class	Packaging
T05-10160HW	Lyra LED 2700–6500K M600	43	4000	>80	48	264	7000	5000	104	A+	1
T05-10165HW	Lyra LED 2700–6500K M625	43	4000	>80	48	264	7000	5000	104	A+	1

R_a>90 on request

Application examples



Typical installation of **Atomic TOP LED HCL**. Human Centric Lighting luminaires perfectly fits into classrooms and lecture halls where their potential can be fully used due to their influence on efficiency and learning ability of students.



Ensuring a natural Circadian rhythm is important for the well-being and faster treatment of patients. Ceiling luminaire **Arietis LED HCL** in Human Centric Lighting version is perfect for healthcare and clean rooms applications.



Offices are usually areas where a high mental performance of employees is required. **Lyra LED HCL** fits perfectly into offices and meeting rooms. HCL luminaires guarantee high visual comfort and contribute to greater concentration and better performance.

1. Switch-Control – simple control button

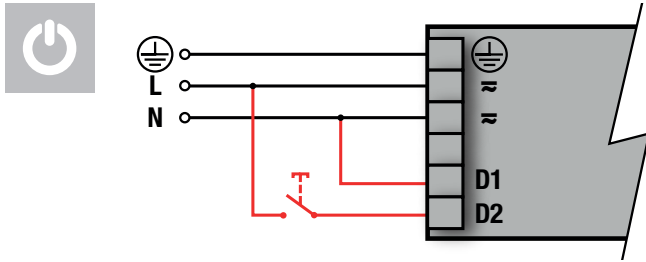

How it works

Short button presses = ON/OFF with memory of last settings

Holding a button with driver in setting to OFF activates the color temperature adjustment after approx. 10s, releasing the button saves the colour temperature

Long button presses changes the intensity of the selected colour

2. Skyline – button panel



Skyline Panel

Code: 99-0302

DALI based multi-panel

DALI power supply

Code: 99-0303

Power supply for one luminaire

3. Spectra – stylish user interface



Spectra panel

Front control panel is available in a choice of glass or plastic, black or white finish



99-0305PC

Material: plastic
Colour: black



99-0305SC

Material: glass
Colour: black



99-0305PB

Material: plastic
Colour: white

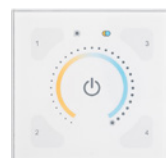

99-0305SB

Material: glass
Colour: white

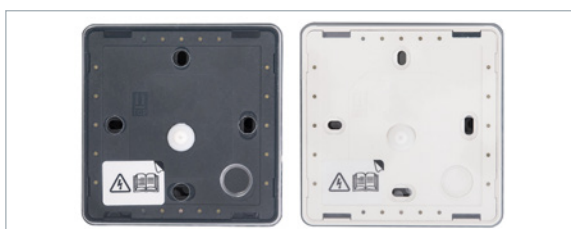

DALI interface

Code: 99-0306DI (black colour)

Code: 99-0306DIW (white colour)

Size and design according to the number of luminaires



DALI power supply

Code: 99-0310 (up to 35 luminaires)

Code: 99-0311 (up to 63 luminaires)

Size and design according to the number of luminaires

Technical annex – components

All in One Package



Spectra Power – user interface and power supply

Package – front Spectra panel and DALI power supply, max. for 20 luminaires



99-0307PC
Material: plastic
Colour: black



99-0307SC
Material: glass
Colour: black



99-0307PB
Material: plastic
Colour: white



99-0307SB
Material: glass
Colour: white

Example of use for Spectra – office room

Used products

- 1 x Spectra panel – Front control panel
- 1 x DALI interface
- 1 x DALI power supply
- 1 x Ceiling DALI motion sensor
- 9 x Tunable White LED luminaires – Lyra LED HCL

SceneSet® Lighting Control App
for smartphone and tablet



Scene selection

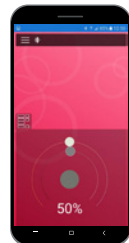

Colour temp. control

Bluetooth



Spectra panel:
- Front control panel – plastic, black (code: 99-0305PC)
- DALI interface (code: 99-0306DI)



DALI power supply
(code: 99-0311)

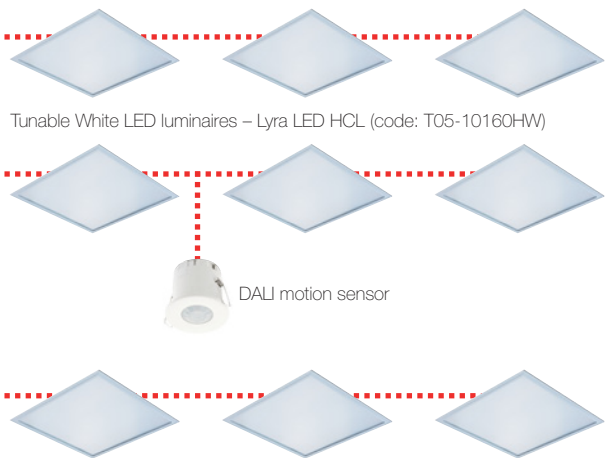

4. Vision – HCL Project solution



DALI channel ballast controller Vision

Tailor-made project solution

Project solution always designed according to specific requirements of the user

