

Dot

emergency

nuBe



IP65

IK07

850°

+40°C
0°C



10
YEARS

+45°C
-10°C



archieco : clean and elegant design lines with surfaces that can be painted together with the wall, made of recyclable and partly compostable materials.



Small dimensions with a luminous flux of up to 1000lm. Possibility to integrate laser signage with an Orma IP65 module.



By rotating the lens, the luminaire is suitable for both large areas (225m²) and escape routes up to 23m.



Double optical scheme made up of two pairs of lenses rotating on the axis and alternatively matching two high-efficiency LEDs.

Applications

Services, offices, cinemas, hotels, museums, schools, shops, shopping centres, design rooms

Characteristics

Power supply 230VAC ± 10%, 50÷60Hz

Mounting Recessed

Recharging time 12h

Housing PHA white RAL 9003

Optics PMMA

Compliance EN 60598-1, EN 60598-2-2, EN 60598-2-22, UNI EN 1838, UNI 11222, EN 62034

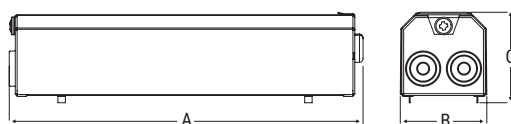
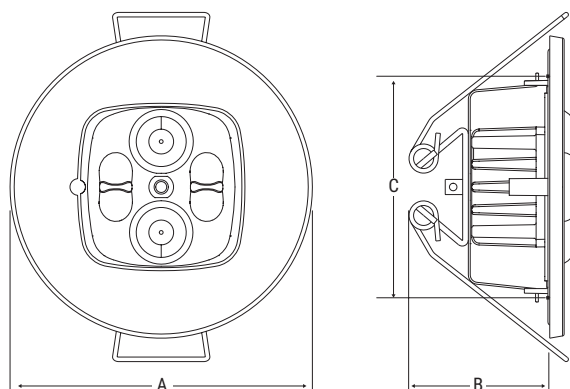



SURFACE TREATMENT
WHICH ALLOWS IT TO BE PAINTED
EVEN WITH COMMON WALL PAINTS

	Dimensions mm		
	A	B	C
Luminaire	Ø 80	38	Ø 59
Inverter versions TR-AT	191	47	49
Inverter version LG	254	47	52

080

Performance according to EN 1838

Lens	Height (m) 	Centre distance (m) ESCAPE ROUTES 		Illuminated surface area (m) LARGE AREAS 	
		Wall	Ceiling	Wall	Ceiling
Lungaluce	3	-	30	-	-
Largaluce	3	-	-	-	14x16
Altaluce	7	-	12	-	10x6

Lighting >1lx at floor level along the centre line without reflections Emax/Emin <40

Lighting >0.5lx at floor level without reflections Emax/Emin <40

Performance with reference to luminaire Order Code 19712 1000lm

Maintenance coefficient 0.8



LUNGALUCE

80%

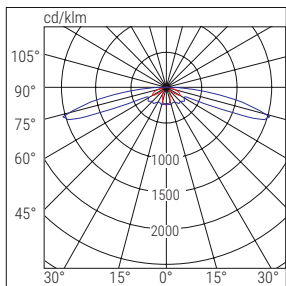

■ C90-C270 ■ C0-C180

LARGALUCE

91%

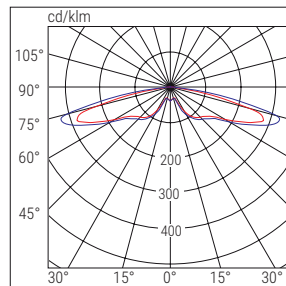

■ C0-C180 ■ C90-C270

ALTALUCE

90%

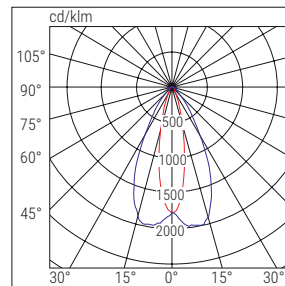

■ C0-C180 ■ C90-C270

ASIMMETRICA

90%

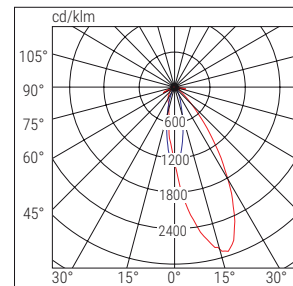

■ C0-C180 ■ C90-C270

LENS ACCESSORY - to be ordered separately



LENS ALTALUCE - ASIMMETRICA

Order Code **19887**

MODULE ORMA

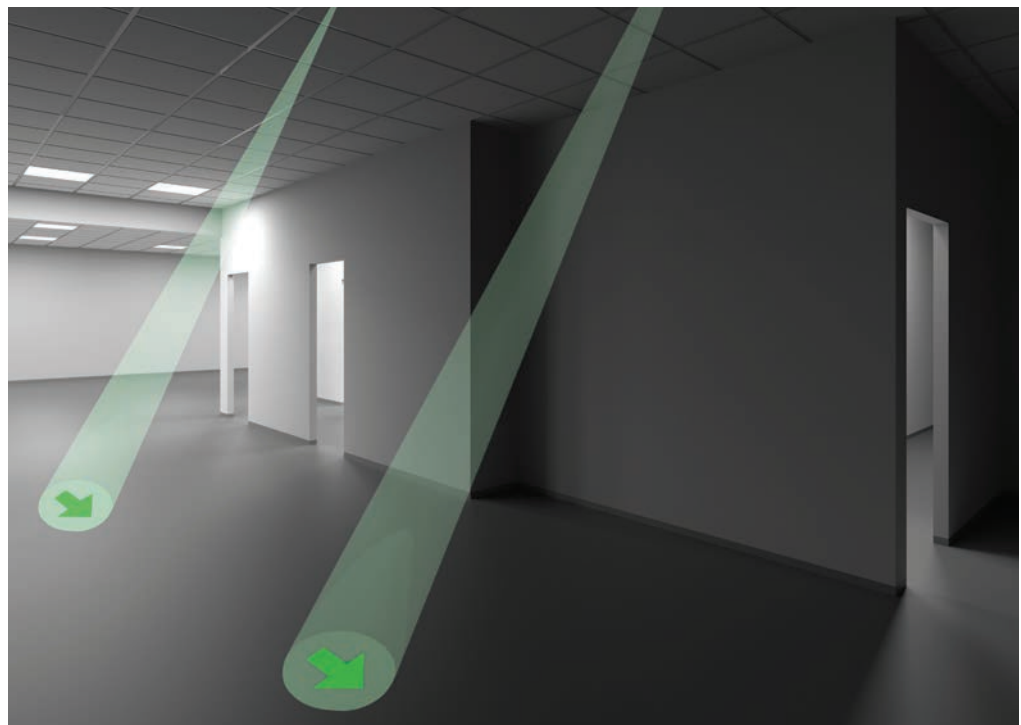

ORMA LASER MODULE

Laser micro-projector that emits a bright and prominent arrow-shaped asymmetrical conical beam, producing a virtual pictogram to indicate the nearest escape route. To position the image on the ground at the most suitable point and with the correct signal orientation, simply rotate the body of the device.



Dot

emergency

	Order code	W	Descrizione	Version	Autonomy h	Flux SE lm	Flux SA lm	Input power		Note
								DC	AC	
TR	19700	24	DOT AE SE/SA 1/2/3H IP65 RM	SE/SA	1/2/3	550/300/200	240		2 W	
AT	19713	24	DOT AE AT SE/SA IP65	SE/SA	1/1.5/2/3/8	550/380/300/200/100	240		5 W	
	19714	GL	DOT AE GL AT SE/SA IP65	SE/SA	1/1.5/2/3/8	1000/700/550/400/150	240		5 W	
CT	19711	24	DOT AE CT SE/SA IP65	SE/SA	1/1.5/2/3/8	550/380/300/200/100	240		5 W	
	19712	GL	DOT AE GL CT SE/SA IP65	SE/SA	1/1.5/2/3/8	1000/700/550/400/150	240		5 W	

CT luminaires can integrate optional modules for expansion to other systems: LG module code 15036 - LGFM module code 15037 - DALI module code 15038

ACCESSORIES - to be ordered separately



ORMA LASER MODULE
Only for Order 19700 and 19711
Order Code **19883**



LG - LGFM - DALI MODULE (AT-OPT version only)
LGFM - Order Code **15037 - 19375**
LG - Order Code **15036**
DALI - Order Code **15038** 



RM INIBIT REMOTE CONTROL
RM for TR versions only
Order Code **2730** 