



Beghelli
IDEE PIENE DI VITA

REVERSO **illuminazione**
2024 Lighting

Idee piene di vita

Le idee, e quindi l'innovazione, sono alla base dell'operato di Beghelli, che dal 1982 progetta soluzioni che permettono alle persone di vivere il proprio ambiente di lavoro e di vita in serenità e salute, avendo come naturale prerequisito il rispetto dell'ambiente.

Grazie all'attenzione alle esigenze della vita reale, Beghelli è capace di anticipare le tendenze e le richieste del mercato, guidata in questo dalla consapevolezza che tutto nasce da un'intensa attività di ricerca e sviluppo.

Il benessere delle persone e dell'ambiente, il risparmio energetico, la facilità di utilizzo, sono al centro dell'attenzione di Beghelli e alla base di tutte le sue idee.

Idee piene di vita.

Ideas full of life

Ideas, and hence innovations are at the heart of Beghelli's mission. Beghelli has been designing solutions since 1982 that allow people to live and work in harmony with environment and to keep their environmentally friendly lifestyle as a natural prerequisite.

Thanks to Beghelli's attention to real-life demands, Beghelli has the capacity to anticipate market trends and requirements and is driven by the awareness that everything stems from intense research and development.

The wellbeing of people and the environment, energy saving, ease of use, are the focus of Beghelli and the basis of all its ideas.

Ideas full of life.



IDEE PIENE DI VITA

Indice

Proposte Esclusive Beghelli

■ NuBe Beghelli Cloud	004
■ App B.connect	006
■ Gestione impianto Bluetooth	007
■ Modula system	008
■ Natural light	004
■ Inverter universale	004
■ SanificaAria	004

Sistemi e apparecchi di illuminazione

■ Centrali di controllo	010
■ Incasso e plafone	012
■ Downlight	050
■ Plafoniere stagne	074
■ Riflettori industriali	100
■ Proiettori da esterno	116
■ Armature stradali	146

Legenda simboli..... P.154

Indice analitico

Resistenza chimica dei materiali..... P.170

Condizioni generali di vendita..... P.172

Index

Exclusive Beghelli proposals

■ NuBe Beghelli Cloud	004
■ Managing by Bluetooth connection	006
■ Managing by Bluetooth connection	007
■ Modula system	008
■ Natural light	004
■ Blu technology	004
■ SanificaAria	004

Systems and emergency luminaires

■ Control Units	010
■ Recessed and ceiling	012
■ Downlight	050
■ Waterproof ceiling lights	074
■ Industrila high bay lights	100
■ Outdoor floodlights	116
■ Street lights	146

Key to symbols..... P.155

Analytical index

Materials chemicals resistance..... P.170

Terms and conditions of sale..... P.174

Indice / Index

DRIVER DI ALIMENTAZIONE E SISTEMI CONTROLLO / POWER SUPPLY AND CONTROL SYSTEMS

ED

ED - TRADIZIONALE
Apparecchi dotati di driver LED tradizionale a luce fissa o dimmerabili 0÷10V.

ED - TRADIZIONALE
Luminaires equipped with traditional LED drivers with fixed light or dimmable 0÷10V.

ON / OFF

RD

RD - REGOLABILE
Apparecchi dotati di driver regolabile con modulazione del flusso luminoso su quattro step, tramite switch integrato.

RD - ADJUSTABLE
Luminaire equipped with adjustable driver with four step luminous flux modulation via integrated switch.

REGOLABILE
ADJUSTABLE

DALI2

DALI
Apparecchi dotati di driver compatibile con protocollo di comunicazione DALI



DALI
Luminaires equipped with DALI driver are compatible with communication protocol

DALI

CENTRALE DI CONTROLLO / CONTROL UNIT - NUBE BEGHELLI CLOUD



BEGHELLI CLOUD

P. 004



**Controllo/Control
LG - LGFM**

SD

P. 010

INCASSO E PLAFONE / RECESSED AND CEILING

ADVANCED



Led Panel RTI

Sanifica **ARIA** Beghelli

ED DALI SD

P. 012

ADVANCED



Lens Panel

ED DALI SD

P. 020

STANDARD



Led Panel

IP40-IP20

ED DALI SD

P. 024

STANDARD



Backlight Panel

ED

P. 028

ADVANCED



Clinic Panel

IP65

ED DALI SD

P. 030

ADVANCED



P236/258

IP20

RD DALI SD

P. 034

STANDARD



Full Moon

IP65 - IP44

ED

P. 038

STANDARD



GeoLed

IP65

ED

P.042

STANDARD



RegLed

IP20

ED

P. 046

DOWNLIGHT

ADVANCED



Downlight System

IP20-IP54

RD DALI SD

P. 050

STANDARD



Downlight

IP42 - IP20

ED

P. 056

STANDARD



Downlight SQ

IP20

ED

P. 062

STANDARD



X-Six

IP20

ED RD

P. 064

STANDARD



X-Six SQ

IP20

ED RD

P. 070

ARMATURE STRADALI / STREET LIGHTING

ADVANCED



Strada MODULA

IP66

ED MV SD

P. 146

ADVANCED



Strada

IP66

DALI MV ZHAGA

P. 150



Connettività Bluetooth Integrata e moduli di espansione opzionali: Radio 2.4GHz, Inverter e Autodimmer intelligente

Integrated Bluetooth connectivity and optional expansion modules: 2.4GHz Radio, Inverter and Autodimmer



Autodimmer intelligente integrato, moduli di espansione opzionali: DALI, Radio 2,4 GHz, 1÷10V, Inverter

Integrated intelligent autodimmer, optional expansion modules: DALI, 2.4 GHz Radio, 1÷10V, Inverter









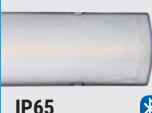

Connettività Radio 2,4GHz e sensore **Autodimmer intelligente integrato**

2.4GHz Radio connectivity and integrated intelligent Autodimmer sensor

GESTIONE INTELLIGENTE CON POSSIBILITÀ DI CONTROLLO DI OGNI APPARECCHIO IN MODALITÀ WIRELESS BLUETOOTH - RADIO - DALI CON AUTODIMMER INTEGRATO O OPZIONALE
INTELLIGENT MANAGEMENT SYSTEM WITH THE POSSIBILITY ON EACH DEVICE OF WIRELESS BLUETOOTH - RADIO - DALI CONTROL WITH AUTODIMMER INCLUDED OR TO BE ORDER SEPARATELY







PLAFONIERE STAGNE / WATERPROOF CEILING LIGHTS

ADVANCED		BS Uno MODULA RD DALI SD		P. 074
ADVANCED		BS100 RD DALI SD		P. 078
ADVANCED		Acciaio RD DALI SD		P.082
ADVANCED		Acciaio Extreme SD DALI		P. 086
STANDARD		Saving Stagna ED		P. 090
STANDARD		Saving Stagna Slim ED		P. 094
STANDARD		Stagna Easy Led ED		P. 096
STANDARD		Stagna Easy CCT ED		P. 098

RIFLETTORI INDUSTRIALI / INDUSTRIAL HIGH BAY LIGHTS

ADVANCED		H-PRO MODULA RD DALI SD		P. 100
ADVANCED		H-PRO RD DALI SD		P. 104
ADVANCED		BS240 RD DALI SD		P. 108
ADVANCED		Highbay HP ED DALI SD		P. 112
STANDARD		Highbay Multipower RD		P. 114

PROIETTORI DA ESTERNO / OUTDOOR FLOODLIGHTS

ADVANCED		Flood MODULA RD DALI SD		P. 116
STANDARD		Floodlight ED		P. 128
ADVANCED		Flood Mini ED		P. 132
ADVANCED		FH RD DALI SD		P. 134
ADVANCED		Power Light DALI SD		P. 142

Proposte esclusive Beghelli / Exclusive



NuBe è la piattaforma WEB di accesso e gestione di tutti gli impianti Beghelli in cloud che permette di gestire e tenere sotto controllo sia l'illuminazione che l'illuminazione di emergenza.

Fra i tanti servizi proposti sarà attivabile la manutenzione predittiva, funzione in grado di anticipare all'utilizzatore interventi di manutenzione all'impianto in modo da prevenire malfunzionamenti.

NuBe is the WEB platform for accessing and managing all Beghelli systems in the cloud which allows you to manage and keep both lighting and emergency lighting under control.

Among the many services offered, predictive maintenance can be activated, a function capable to anticipate maintenance interventions on the system to the user in order to prevent malfunctions.



B.connect

Gli apparecchi dotati di Smart Driver Bluetooth dispongono di tutte le funzioni presenti nel Driver SD-X. Possono essere connessi sia alle Centrali SD LGFM Beghelli integrando il Modulo Radio opzionale che ad un Concentratore Bluetooth che funziona come centrale. La funzione Autodimmer, è attivabile con l'apposito accessorio.

La App B.connect permette il controllo in locale degli apparecchi e l'accesso alla sezione NuBe Beghelli Cloud, dove è possibile creare nuovi impianti e gestire quelli già installati.

Luminaires equipped with the Bluetooth Smart Driver have all the functions present in the SD-X Driver. They can be connected both to the Beghelli SD LGFM control units by integrating the optional Radio Module and to a Bluetooth concentrator that functions as a control unit. The Autodimmer function can be activated with a dedicated accessory.

The B.connect App allows local control of the equipment and access to the NuBe Beghelli Cloud section, where it is possible to create new systems and manage those already installed.

30% di risparmio energetico in più
NATURAL LIGHT
AUTODIMMER

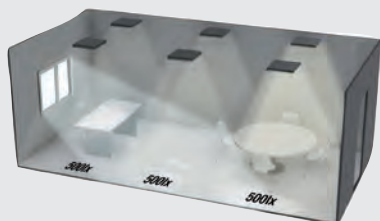

Gli apparecchi dotato di sensore Autodimmer sono autonomi nella modulazione del flusso luminoso e regolano automaticamente l'intensità luminosa in funzione della luce già presente nell'ambiente. Nel caso di apparecchi Bluetooth, possono essere collegati ad un solo sensore, sia integrato che esterno all'apparecchio, ma anche ad un pulsante Bluetooth per il comando manuale.

The luminaires equipped with an Autodimmer sensor are autonomous in modulating the luminous flux and automatically adjust the luminous intensity based on the light already present in the environment. In the case of Bluetooth equipped luminaires, they can be connected to a single sensor, either integrated or external to the luminaire, but also with a Bluetooth switch for manual control.

Anche in versione Bluetooth
Also in Bluetooth version

Beghelli proposals

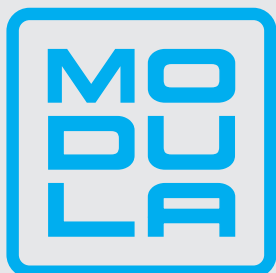

Sistema di installazione rivoluzionario che integra nell'apparecchio una staffa di derivazione capace di contenere i cablaggi elettrici, una morsettiera estraibile e vari moduli Inverter sia tradizionale TR, che centralizzato LG230-LG24.

Ogni Inverter viene fornito alloggiato nella specifica staffa modula con attacco rapido per non inficiare le caratteristiche di sicurezza dell'apparecchio.

Revolutionary installation system which integrates into the appliance a junction bracket capable of containing the electrical wiring, an extractable terminal block and various inverter modules, both traditional TR and centralized LG230-LG24.

Each inverter is provided and held in the specific modular bracket with quick connection so as not to affect the safety characteristics of the appliance.

INVERTER universale

L'Inverter universale permette il collegamento con APPARECCHI DOTATI DI sorgenti LED con tensione variabile da 20V fino a 240V. E' disponibile in versione AT, CT in connettività Bluetooth. Il controllo può essere effettuato da App B.Connect via Bluetooth oppure da Centrale integrando il Modulo radio LGFM, LG o DALI.

The universal inverter allows connection with LUMINAIRES EQUIPPED WITH LED sources with variable voltage from 20V up to 240V. It is available in AT, CT in Bluetooth connectivity. Control can be carried out from the B.Connect App via Bluetooth or from the Control Unit by integrating the LGFM, LG or DALI radio module.

Sanifica **ARIA** **Beghelli**
EFFICACIA TESTATA SU VIRUS E BATTERI

fino al
99.9%

Apparecchi ibridi per illuminazione ordinaria con sanificatore dell'aria integrato. Il dispositivo di sanificazione si basa su una Cella di flusso UV-C a camera chiusa, senza emissioni di Ozono. Il sistema, grazie all'esclusiva tecnologia uvOxy®, elimina ogni rischio durante il suo funzionamento e permette la sanificazione continua degli ambienti in presenza di persone.

Hybrid luminaires for ordinary lighting with integrated air sanitizer.

The sanitization device is based on a closed chamber UV-C flow cell, without ozone emissions. The system, thanks to the exclusive uvOxy® technology, eliminates any risk during its operation and allows the continuous sanitization of environments in the presence of people.

Gestione impianto tramite Bluetooth /

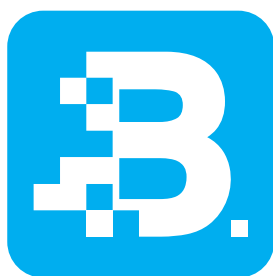

B.connect

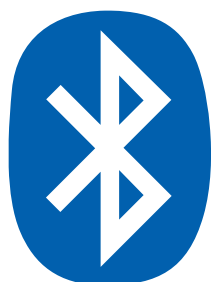

Trasformazione da impianto Autotest AT in Centraltest CT a "costo zero"



Change from Autotest AT system to Centraltest CT at "zero cost"

AUMENTA L'EFFICIENZA ENERGETICA DEI TUOI IMPIANTI FINO AD OLTRE L'80%

INCREASE THE ENERGY EFFICIENCY OF YOUR SYSTEMS UP TO OVER 80%

Da oggi, tutti i nuovi prodotti di illuminazione Beghelli SD saranno equipaggiati anche con la nuova tecnologia SD Bluetooth, dotata di interfaccia di trasmissione BLE e di grafica di programmazione impianto, completamente rivista e semplificata grazie all'utilizzo di App B.connect. Studiata per la realizzazione di piccoli impianti domotici (zone fino a 64 apparecchi), la tecnologia SD Bluetooth consente soluzioni di automazione della gestione della luce arrivando a livelli efficienza energetica elevatissimi, con risparmi fino ad oltre l'80%. L'interfaccia Bluetooth integrata ha una portata fino ad oltre 10m, pertanto in applicazioni di grandi dimensioni, si consiglia l'integrazione del Modulo radio per una soluzione più efficiente.

From today, all the new Beghelli SD lighting products will also be equipped with the new SD Bluetooth technology, equipped with a BLE transmission interface and system programming graphics, completely revised and simplified thanks to the use of the B.connect App. Designed for the creation of small home automation systems (64 luminaires max for zone), SD Bluetooth technology allows automation solutions for light management reaching very high energy efficiency levels, with savings of up to over 80%. The integrated Bluetooth interface has a range of up to over 10m, therefore in large applications, the integration of the Radio Module is recommended for a more efficient solution.

		
PROGRAMMAZIONE <i>PROGRAMMING</i>	Locale B.connect - Remoto NuBe <i>Local B.connect - Remote Cloud</i>	Locale SD Manager Remoto NuBe <i>Local SD Manager Remote NuBe</i>
TECNOLOGIA <i>TECHNOLOGY</i>	Piccoli gruppi di apparecchi, tutti in portata Bluetooth <i>Small groups of devices, all within Bluetooth range</i>	Gruppi di apparecchi di grandi dimensioni con rete magliata (MESH) <i>Large device groups with meshed network</i>
PORTATA <i>PORTATA</i>	10 metri <i>10 meters</i>	Infinite MESH
CENTRALINA N. APPARECCHI MAX <i>CONTROL UNIT NO. OF LUMINAIRES MAX</i>	NO - Gateway opzionale - 64 Apparecchi <i>NO - Optional gateway - 64 luminaires</i>	SI - 996 Apparecchi <i>YES - 996 luminaires</i>
TIPOLOGIA IMPIANTO <i>SYSTEM TYPE</i>	Terziario, piccolo industriale <i>Tertiary sector, small industrial sector</i>	TUTTI <i>EVERYONE</i>
MONITORAGGIO - DOMOTICA <i>MONITORING - HOME AUTOMATION</i>	Locale B.connect - Remoto NuBE <i>Local B.connect - Remote NuBE</i>	Locale SD Manager Remoto NuBe <i>Local SD Manager Remote NuBe</i>
PROTOCOLLO RADIO <i>RADIO PROTOCOL</i>	Bluetooth BLE <i>Bluetooth BLE</i>	Spread spectrum (FH-DSSS)

Managing by Bluetooth connection

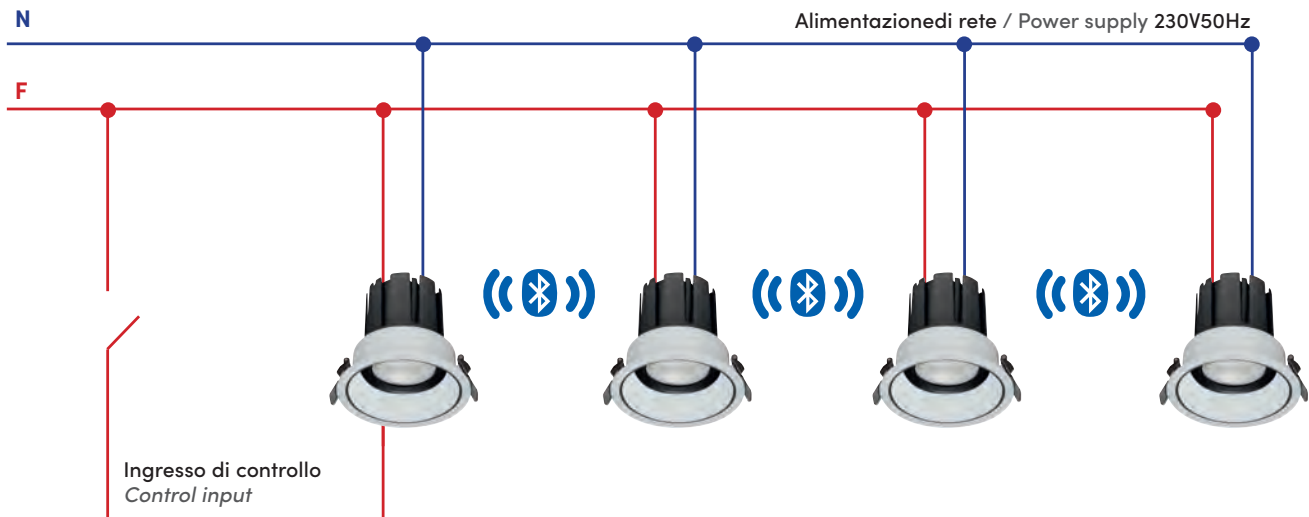

LA DOMOTICA ALLA PORTATA DI TUTTI, SENZA MODIFICHE ALL'IMPIANTO DI ILLUMINAZIONE, NELLE AREE DI PICCOLE E MEDIE DIMENSIONI

Gli apparecchi SD Bluetooth sono dotati di un ingresso di controllo che può essere configurato in varie modalità. Nell'esempio, l'ingresso viene utilizzato per regolare la luminosità delle lampade nella stessa zona senza un cablaggio dedicato: le lampade sono sempre alimentate ed un pulsante è collegato all'ingresso di controllo di una delle lampade che invia il comando via Bluetooth alle altre lampade preconfigurate opportunamente. Questa è solo una delle infinite applicazioni possibili, grazie all'utilizzo dell'ampia gamma di accessori disponibili, come il Sensore di presenza, il Modulo trasmettitore e i Concentratori per il collegamento al Cloud NuBe Beghelli.

HOME AUTOMATION WITHIN EVERYONE'S REACH, WITHOUT MODIFICATIONS TO THE LIGHTING SYSTEM, FOR SMALL AND MEDIUM-SIZED AREAS

SD Bluetooth luminaires are equipped with a control input that can be configured in various modes. In the example, the input is used to adjust the brightness of the lamps in the same area without dedicated wiring: the lamps are always powered and a switch is connected to the control input of one of the lamps which sends the command via Bluetooth to the other duly pre-configured lamps. This is just one of the infinite possible applications, thanks to the use of the wide range of accessories available, such as the presence sensor, the transmitter module and the concentrators for connection to the Beghelli NuBe Cloud.

LA APP B.CONNECT PERMETTE IL CONTROLLO IN LOCALE DEGLI APPARECCHI E L'ACCESSO ALLA SEZIONE NUBE BEGHELLI CLOUD, DOVE È POSSIBILE CREARE NUOVI IMPIANTI E GESTIRE QUELLI GIÀ INSTALLATI.

THE B.CONNECT APP ALLOWS LOCAL CONTROL OF THE EQUIPMENT AND ACCESS TO THE NUBE BEGHELLI CLOUD SECTION, WHERE IT IS POSSIBLE TO CREATE NEW SYSTEMS AND MANAGE THOSE ALREADY INSTALLED.



Modula system: Box di derivazione m

Gli apparecchi con il Box integrato per il cablaggio rapido e l'inserimento delle varie espansioni
Luminaires with integrated Box for quick wiring and upgrade with variuos system expansions

Il sistema Modula Beghelli permette la semplificazione dell'impianto e la riduzione dei tempi di installazione. La possibilità di non utilizzare scatole di derivazione è uno dei focus della nuova metodologia di installazione: la scatola di derivazione tradizionali viene sostituite dall'Easy Box, integrato in ogni apparecchio della serie Modula. Durante l'installazione, il Box può essere utilizzato per cablare elettricamente l'apparecchio prima dell'installazione e, nella versione SD, per l'inserimento dell'espansione per l'illuminazione di emergenza.

MO
DU
LA

Beghelli

Beghelli's Modula system allows simplification of the installation and reduction of installation time. The possibility of not using junction junction boxes is one of the focuses of the new installation methodology: traditional junction box replaced by the Easy Box, integrated in every fixture of the Modula series. During installation, the Box can be used to electrically wire the appliance before installation and in the SD version, for inserting the expansion for emergency lighting.



REGOLAZIONE DELLA POTENZA E INTEGRAZIONE DELL'EMERGENZA

POWER ADJUSTMENT AND EMERGENCY INTEGRATION

Nelle **versioni RD** delle **BS UNO Modula**, è presente lo switch di regolazione della potenza e lo slot per il Modulo di emergenza opzionale.

*In the **RD versions** of the **BS UNO Modula**, there is a power regulation switch and a slot for the optional emergency module.*



MORSETTIERA ESTRAIBILE E CABLAGGIO PASSANTE

REMOVABLE TERMINAL BLOCK AND THROUGH WIRING

Il Box delle **BS UNO Modula**, contiene una morsettiera a scatto per velocizzare l'installazione.

*The **BS UNO Modula** contains a removable terminal block to speed up installation.*



INTEGRAZIONE CON MODULO RADIO E INSERIMENTO DELL'EMERGENZA

INTEGRATION WITH RADIO MODULE AND EMERGENCY INSERT

Nelle **versione SD** delle **BS UNO Modula**, sono presenti due slot per inserire il Modulo radio e il Modulo emergenza opzionale.

*In to **BS UNO Modula SD versions**, there are two slots to insert the radio module and the optional emergency module.*

MODULA EASY BOX

Modulare / modular junction Box

Integrazione dell'emergenza senza interventi sul cablaggio dell'apparecchio di illuminazione *Emergency lighting integration without opening the luminaire or modifying the wiring*

La linea di riflettori e proiettori Modula mantiene il concetto di modularità del sistema, integrando un Box di derivazione in tutti gli apparecchi che consente la connessione diretta singola oppure il cablaggio passante con morsettiere ad innesto rapido. La versatilità del sistema permette di non avere limiti dimensionali rispetto ai cavi da utilizzare senza aprire il prodotto. Il Box di derivazione integrato permette di evitare scatole di derivazione aggiuntive e di inserire un Modulo opzionale in alluminio pressofuso che contiene il Modulo di emergenza.

H-PRO Modula and Flood Modula line maintain the concept of modularity of the system, integrating a junction box in all luminaires that allows direct connection or through-wiring with a quick-connect terminal block. The versatility of the system allows no dimensional limits for the cables that are used without opening the product. The integrated junction box allows to avoid additional junction boxes and to insert an optional die-cast aluminium module containing the emergency module.

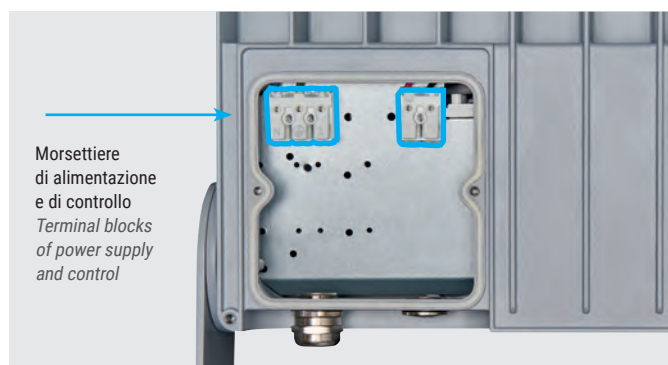

BOX DI DERIVAZIONE CON VANO MORSETTIERE DI ALIMENTAZIONE E CONTROLLO, PER IL CABLAGGIO RAPIDO E ALLOGGIAMENTO DEI MODULI EMERGENZA

JUNCTION BOX WITH POWER AND CONTROL TERMINAL BLOCK COMPARTMENT, FOR QUICK WIRING AND HOUSING OF EMERGENCY MODULES

Struttura completamente in alluminio con pressacavo in acciaio progettata per accogliere cavi fino a 12mm anche per cablaggio passante. L'ampio spazio per i cavi evita l'installazione di una scatola di derivazione esterna.

Full aluminium construction with steel cable gland designed to accommodate cables up to 12mm even for through-wiring. The large space for cables avoids the installation of an external junction box.



MODULI EMERGENZA SOSTITUENDO IL BOX MODULA *EMERGENCY MODULES BY REPLACING THE MODULA BOX*

Il coperchio del Box di derivazione di proiettori e riflettori Modula può essere sostituito con varie tipologie di Moduli emergenza senza aprire il corpo lampada.

The cover of junction box for Flood modula and H-PRO Modula can be replaced with various emergency modules without opening the lamp housing.

FINO A 50.000 lm



PRESTAZIONI ILLUMINOTECNICHE FINO A 50000lm *LIGHTING PERFORMANCE UP TO 50000lm*

La linea Modula di proiettori e riflettori ha sviluppato alte prestazioni illuminotecniche e, nella versione SD, dispone di trasmettitore Bluetooth con Autodimmer e Modulo radio opzionali.

The Modula line of H-PRO and FLOOD developed for high lighting performance. In the SD version features a Bluetooth transmitter with Autodimmer and optional radio module.

Centrale / Control Unit Logica SD LG

illuminazione / lighting



Caratteristiche

Alimentazione 230Vac $\pm 10\%$, 50-60Hz

Installazioni su barra DIN 9 moduli

Apparecchi gestiti fino a 996 dispositivi radio gestibili tra lampade di illuminazione, di emergenza e dispositivi domotici.

Interfaccia di collegamento

Radio Spread Spectrum SFH DSSS su 16 canali, UMTS 4G slot mini SD (SIM inclusa), WiFi - modalità AccesPoint (AP) e modalità Client (STA), Ethernet, USB (2 porte), Bluetooth, RS485, RS232, 4 porte IN e 2 porte OUT

Software di gestione

App B.connect, NuBe, SD Manager, Logica visual

Scheda di memoria

SD Card (non inclusa)

Conformità EN60950-1, EN62034, EN50172, 2014/53/UE

Applicazioni

Industriale, terziario

Characteristics

Power supply 230VAC $\pm 10\%$, 50-60Hz

Mounting 9 DIN rail modules

Managed luminaires up to 996 manageable radio luminaires including lighting lamps, emergency lamps and home automation devices.

Connection interface

SFH DSSS Radio Spread Spectrum on 16 channels, UMTS 4G slot mini SD (SIM included), WiFi - AccesPoint (AP) mode and Client (STA) mode, Ethernet, USB (2 ports), Bluetooth, RS485, RS232, 4 x IN ports and 2 x OUT ports

Management software

B.connect App, NuBe, SD Manager, Logica visual

Memory card

SD Card (not included)

Compliance EN60950-1, EN62034, EN50172, 2014/53/EU

Applications

Industry, service sectors

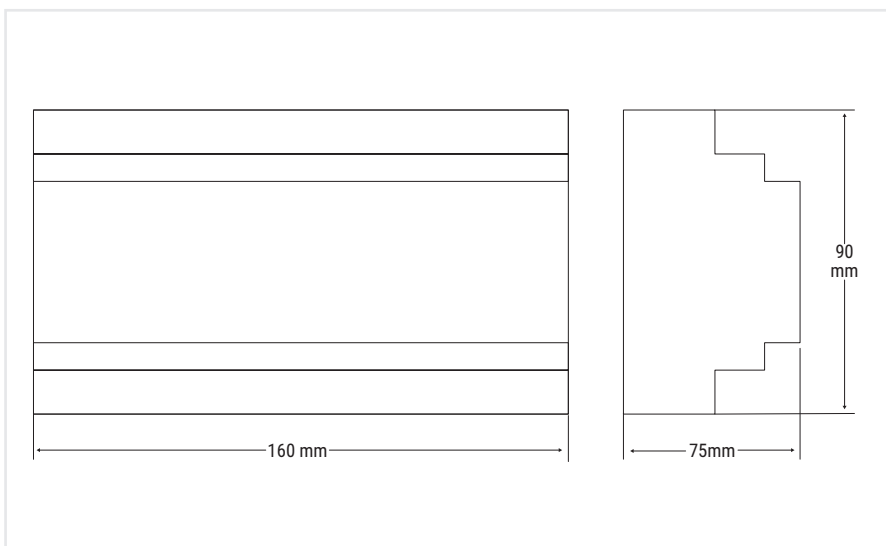

010

FUNZIONI DI CONTROLLO DEL SISTEMA

- Controllo, dimmerazione e diagnostica degli apparecchi
- Gestione di scenari luminosi fino a 256 gruppi da apparecchi
- Definizione della modalità luminosità fissa o Autodimmer
- Misura della potenza istantanea e dell'energia consumata
- Gestione del sistema di emergenza di apparecchi LGFM

SYSTEM CONTROL FUNCTIONS

- Control, diagnostics, and luminaires dimming
- Management of light sceneries up to 256 luminaire groups
- Setting the luminosity mode fixed or autodimmer
- Measurement of instantaneous power and energy consumption
- Management emergency system of LGFM luminaires

SD MANAGER E CATALOGO ELETTRONICO ON-LINE

SD manager è un software progettato per la gestione degli impianti di illuminazione e di illuminazione di emergenza, in grado di centralizzare tutti i comandi in un PC. Il software, attraverso la Centrale Logica SD LGFM, è in grado di controllare l'impianto, sia per impostare i parametri di una nuova installazione che per configurare un impianto esistente con la creazione di gruppi di apparecchi, scenari luminosi e i test dell'eventuale impianto di emergenza collegato. È inoltre possibile posizionare gli apparecchi su una planimetria in formato DWG, su cui si avrà la panoramica completa dell'impianto.

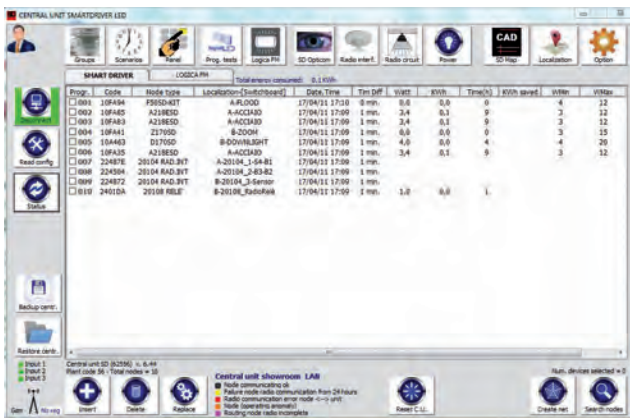

Il software SD Manager può intervenire sulle impostazioni impianto di ogni apparecchio / SD Manager software showing luminaires and system settings.

SD MANAGER AND ON-LINE E-CATALOGUE

SD manager is a software designed for the management of lighting fixtures and emergency lighting fixtures, capable of centralising all commands on a PC. The software, through the Logica SD LGFM Control Unit, can control the system, both to set the parameters of a new system and to set up an existing system with the creation of luminaire groups, lighting sceneries and the testing of any connected emergency system. It is also possible to position the luminaires on a plan in DWG format, on which you will have a complete overview of the system.



On line (www.beghelli.it) è disponibile il Catalogo elettronico con le schede tecniche degli apparecchi The E-catalogue is available on the www.beghelli.it website, contains the technical Datasheet of each luminaires



Cod.	Descrizione Description	Numero apparecchi Number of luminaires	Numero moduli in barra DIN Number of DIN rail modules
 21102	CENTRALE LOGICA SD LGFM (SIM inclusa)	996	9

ACCESSORI - in dotazione / ACCESSORIES - included



SD MANAGER

Cod. Ord. **20109**



CAVO RS485/USB
RS485/USB CABLE
(Per/for cod. 21102)



LED Panel RTI



IP20
IP40

IK05

960°



+40°C
-20°C

CRI>90

UGR<19

FLICKER FREE

Caratteristiche

Mantenimento flusso luminoso a 25°C
>80.000÷120.000h (L80B20)

Installazioni M600, plafone, sospensione

Corpo Lamiera zincata di acciaio verniciata alle polveri di poliestere RAL 9003

Ottica lente microstrutturata in PMMA

Conformità EN60598-1, EN60598-2-2, EN60598-2-22, EN62471 (rischio fotobiologico esente), CAM Criteri Ambientali Minimi secondo DM 11.01.2017, 2014/53/UE, EN60598-2-22

Applicazioni

Terziario, settore pubblico, uffici, scuole

Characteristic

Luminous flux retention a 25°C
>80.000÷120.000h (L80B20)

Mounting M600, ceiling, suspended

Housing Polyester powder-coated pre-galvanised sheet steel, RAL 9003, matt

Optics PMMA micro-structured lens

Compliance EN60598-1, EN60598-2-2, EN60598-2-22, EN62471 (photobiological risk-free), CAM Minimum Environmental Criteria according to DM 11.01.2017, 2014/53/UE, EN60598-2-22

Applications

Services sector, public sector, offices, schools

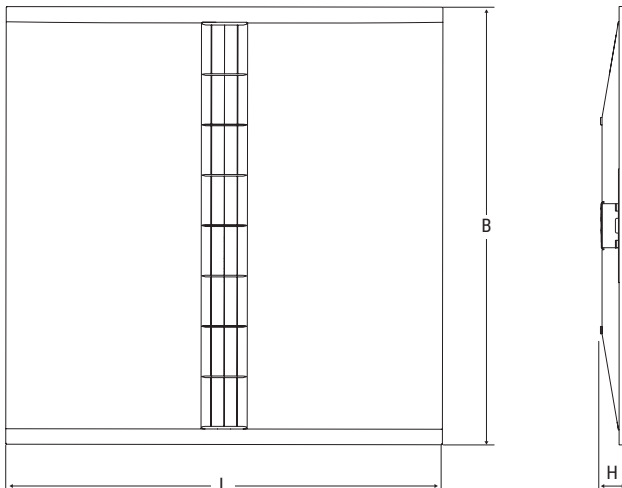

Cod.	Dimensioni mm		
	L	B	H
40151	595	595	34
40161, 40166	595	595	51
40171, 42121	595	595	46
40154, 40157	295	1195	34
40164, 40167	295	1195	51
40174, 40181, 42127	295	1195	46

LED PANEL RTI - 600x600

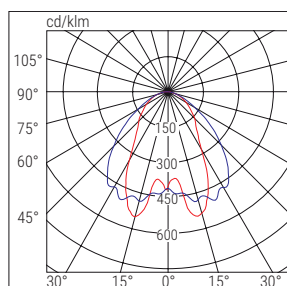

■ C90-C270 ■ C0-C180

LED PANEL RTI - 300x1200

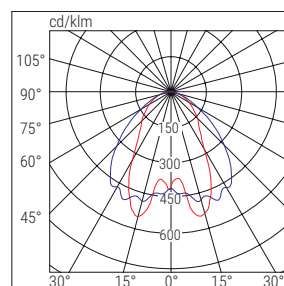
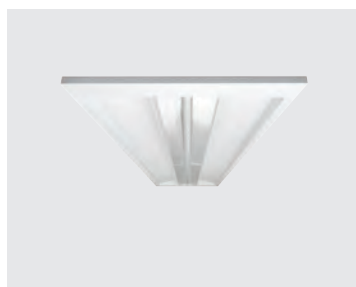

■ C90-C270 ■ C0-C180

	Versione Version	Cod.	Descrizione Description	Potenza Power W	Temp. colore Colour Temp. K	CRI	Flusso LED LED Flux lm (Tj=25°C)	Flusso Flux lm	Efficienza Efficiency lm/W	Kg	Note Notes
ED	600x600	40151	PAN RTI M600 25W U19C90 ED4K	24	4000	>90	4000	3400	142	1.9	
	300x1200	40154	PAN RTI 30x120 25W U19C90 ED4K	23	4000	>90	4000	3400	148	2.7	
	300x1200	40157	PAN RTI 30x120 50W U19C90 ED4K	48	4000	>90	8200	6800	142	2.7	
	600x600	40161	PAN RTI M600 35W U19C90 ED4K	36	4000	>90	6000	5000	139	2.4	
	300x1200	40164	PAN RTI 30x120 35W U19C90 ED4K	35	4000	>90	6000	5000	143	3.8	
	600x600	40166	PAN RTI M600 25W U19C90 HCL	25	HCL 2700 ÷ 6000 CCT 2700-4000-6000	>90	4200	3500	140	2.5	☼*
	300x1200	40167	PAN RTI 30x120 25W U19C90 HCL	24	HCL 2700 ÷ 6000 CCT 2700-4000-6000	>90	4200	3500	146	3.9	☼*

DALI	VERSIONI DALI CODIFICATE / ENCODED DALI VERSIONS:											DALI
	Per creare il codice dell'apparecchio in versione DALI selezionare un apparecchio nella gamma ED ed aggiungere al suo codice il suffisso DL											
	To create the code of the DALI version luminaire, select a luminaire in the range and add the suffix DL to its code											
	Esempio/Example: Cod. 40151 + DL = Cod. 40151DL											

SD	AUTODIMMER										
600x600	40171	PAN RTI M600 35W U19C90 SD4K	36	4000	>90	6000	5000	139	2.5		
300x1200	40174	PAN RTI 30x120 35W U19C90 SD4K	35	4000	>90	6000	5000	143	3.9		
300x1200	40181	PAN RTI 30x120 50W U19C90 SD4K	50	4000	>90	8400	7000	140	3.9		

VARIANTI CON DIVERSA TEMPERATURA COLORE (K) / VERSIONS WITH DIFFERENT COLOUR TEMPERATURES (K)

Gli apparecchi sono disponibili anche in versione 3000K e 6000K. L'elenco dei codici relativi è visionabile nell'Indice analitico, in calce ai codici su indicati con 4000K
The luminaires are also available in 3000K and 6000K versions. A list of the related codes can be found in the Analytical Index, under the above codes with 4000K

☼ HCL-CCT versione HCL-CCT: variazione automatica della T colore in funzione dell'ora solare

Il modulo HCL-CCT consente di regolare la temperatura colore su 3 step 2700K - 4000K - 6000K (CCT) attivabili anche in modalità HCL (Human Centric Lighting), con variazioni luminose automatiche, per adattare l'illuminazione al ciclo biologico umano (illuminazione biodinamica).

The HCL-CCT module allows you to adjust the color temperature in 3 steps 2700K - 4000K - 6000K (CCT) which can also be activated in HCL (Human Centric Lighting) mode, with automatic light variations, to adapt the lighting to the human biological cycle (biodynamic lighting).

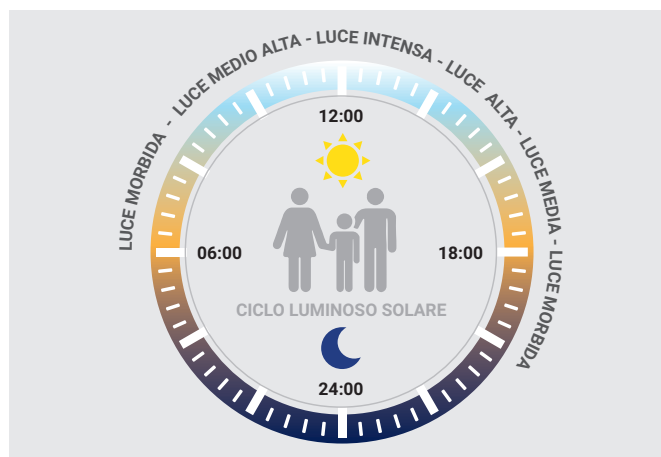

LED Panel RTI

VARIANTI SPECIALI - a richiesta / SPECIAL VARIANTS - on request

TEMPERATURA COLORE 3000K e 6000K, 0-10V / COLOUR TEMPERATURE 3000K and 6000K, 0-10V

ACCESSORI - in dotazione / ACCESSORIES - included



ACCESSORI - da ordinare separatamente / ACCESSORIES - to be ordered separately

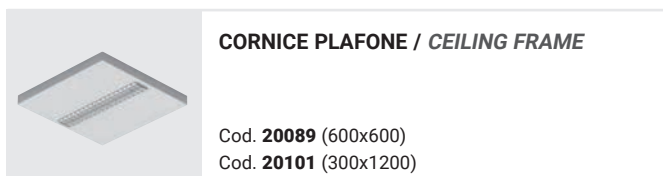
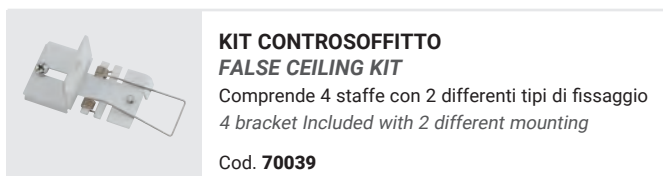
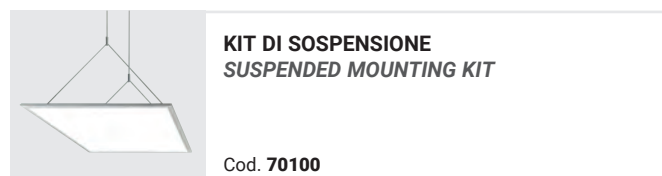

SDRADIO ACCESSORI - da ordinare separatamente / ACCESSORIES - to be ordered separately

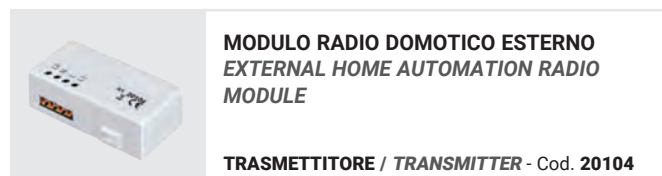

EMERGENZA CON INVERTER LED - da ordinare separatamente
EMERGENCY LED INVERTER - to be ordered separately

COMPATIBILITÀ APPARECCHIO/INVERTER
LUMINAIRE/INVERTER COMPATIBILITY

APPARECCHI LUMINAIRES Cod.	INVERTER COMPATIBILI COMPATIBLE INVERTERS	TIPO DI INSTALLAZIONE TYPE OF MOUNTING	ACCESSORI DI MONTAGGIO MOUNTING ACCESSORIES
40151	19367 - 19371 19398 - 19399	M600	
		plafone/sospensione ceiling / suspended	Staffa / Bracket Cod. 40190
40154 40157	19367 - 19371 19398 - 19399	M600 plafone/sospensione ceiling / suspended	Staffa / Bracket Cod. 40191
40161	19358 - 19359- 19355L - 19391 19398 - 19399	M600	
		plafone/sospensione ceiling / suspended	
40164	19358 - 19359- 19355L - 19391 19398 - 19399	M600	
		plafone/sospensione ceiling/suspended	
40166	19367 - 19371 19398 - 19399	M600	
		plafone/sospensione ceiling/suspended	
40167	19367 - 19371 19398 - 19399	M600	
		plafone/sospensione ceiling/suspended	
40176	19358 - 19359	M600 plafone/sospensione ceiling/suspended	a richiesta on request
	19355L - 19391 19398 - 19399	M600 plafone/sospensione ceiling/suspended	Cover IP65 Cod.19376 a richiesta on request
40177 40178 40168	19358 - 19359- 19355L - 19391 19398 - 19399	M600 plafone/sospensione ceiling/suspended	
40171	19358 - 19359	M600 plafone/sospensione ceiling/suspended	a richiesta on request
	19355L - 19391 19398 - 19399	M600 plafone/sospensione ceiling/suspended	Cover IP65 Cod.19376 a richiesta on request
40174 40181	19358 - 19359- 19355L - 19391 19398 - 19399	M600 plafone/sospensione ceiling/suspended	



INVERTER PLUG&LIGHT SE/SA 1-3h 20-60V
 Cod. **19358** (1h / 20-60V)
 Cod. **19359** (3h / 20-60V)
 Cod. **19367** (1h / 60-180V)
 Cod. **19371** (3h / 60-180V) TR



INVERTER AT/LG AR
 Essenziale per l'installazione Cod. **19376**
 Essential to mounting Cod. **19376**
 Cod. **19355L** (9W-55V Batt. LiFe)
 Cod. **19391** (15W-55V Batt. LiFe) AT LG



MODULO LGFM
 Solo per Inverter LG
 For LG Inverters only
 Cod. **19375** LGFM



INVERTER UNIVERSALE 5W 20-240V
 AT - Cod. **19398**
 CT - Cod. **19399** AT CT



MODULO / MODULE LG - LGFM - DALI
 Solo per Inverter CT / For CT Inverters only
 LG - Cod. **15079**
 LGFM - Cod. **15037**
 DALI - Cod. **15080** LG
LGFM
DALI



COVER INVERTER
 INVERTER COVER
 Cod. **19376**

Led Panel RTI SanificaAria



PROGRAMMABILE



IP20

IK05

960°

+40°C
-20°C

CRI>90

UGR<19

FLICKER FREE

Caratteristiche

Installazioni Modulo 600, sospensione con cavi d'acciaio in dotazione

Corpo Lamiera zincata RAL 9003 opaco

Ottica lente microstrutturata in PMMA

Conformità EN60598-1, EN60598-2-22, EN62471(rischio fotobiologico esente), CAM Criteri Ambientali Minimi secondo DM 11.01.2017, EN60598-2-2, EN60335-2-65, ISO 15714, 2014/53/UE1, EN60598-2-22

Applicazioni

Terziario, settore pubblico, uffici, scuole

Characteristics

Mounting Module 600, suspended with the steel cables supplied

Housing Pre-galvanised sheet metal RAL 9003 matt

Optics PMMA micro-structured lens

Compliance EN60598-1, EN60598-2-22, EN62471(photobiological risk-free), CAM Minimum Environmental Criteria according to DM 11.01.2017, EN60598-2-2, EN60335-2-65, ISO 15714, 2014/53/EU1

Applications

Services, public sector, offices, schools

Caratteristiche del sanificatore Specifications of the Air Purifier

uvOxy® input power 60÷75 W

UV-C wavelength 254nm

Sanitisation flow rate 200 m3/h

UV-C power 48 W

UV-C radiation power 15 W

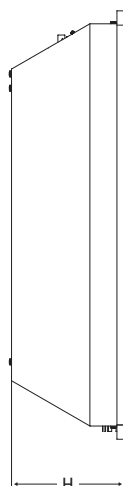
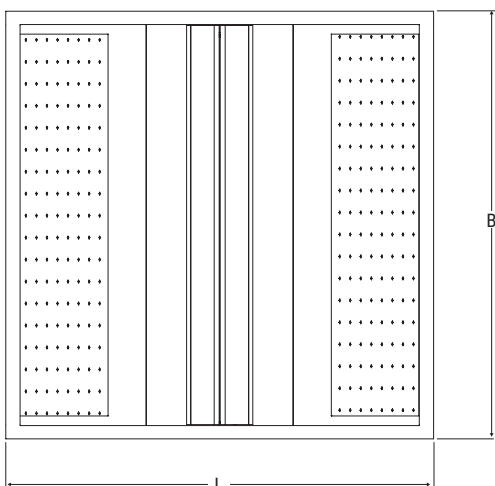

SANIFICAZIONE INIZIALE DI UN AMBIENTE SANITIZATION OF AIR IN AN ENVIRONMENT

Dimensioni ambiente / Room size		
Cubatura Volume m ³	Superficie Surface area m ²	Tempo di sanificazione iniziale Initial sanitization time h
100	40	0.5
200	80	1
300	120	1.5
400	160	2
600	240	3

Valori esemplificativi / Exemplary values

Versione Version	Dimensioni / Dimension mm		
	L	B	H
600x600	595	595	160

LED PANEL RTI SANIFICAARIA - 600x600

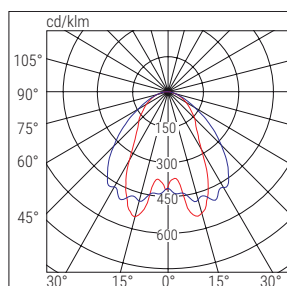

■ C90-C270 ■ C0-C180

M600 SANIFICAARIA - senza illuminazione/ without lighting



	Cod.	Descrizione Description	Potenza Power W	Temp. colore Colour Temp. K	CRI	Flusso LED LED Flux lm (Tj=25°C)	Flusso Flux lm	Sanificazione Sanitisation m³/h			Efficienza Efficiency lm/W	Kg	HCL CCT	
								1	2	3				
RD	40161UV	P RTI M600 35W U19C90 RD4K UV	36	4000	>90	6000	5000	100	150	200	139	7.5		REGOLABILE
SD	40171UV	P RTI M600 35W U19C90 SD4K UV	36	4000	>90	6000	5000	100	150	200	140	7.5		AUTODIMMER
M600	26706	MODULO 600 SANIFICA ARIA	36÷60 W					100	150	200		7.5		SANIFICAZIONE
Apparecchio privo di sorgente luminosa per la sola sanificazione dell'aria degli ambienti integrando l'impianto di illuminazione su Modulo 600x600 Luminaire without light source for only air sanitization in order to integrating the lighting system on the 600x600 Module														

SD	Portata fino a Flow rate up to 200 m³/h	Tempo di sanificazione iniziale Initial sanitisation time 15 minuti	Tempo di sanificazione iniziale Initial sanitisation time 40 minuti
-----------	---	---	---

Prestazione riferita ad una singola installazione in un ufficio di 20 mq
Performance related to a single system in an office of 20 sq m

Prestazione riferita ad un open space con 1 apparecchio ogni 50 mq
Performance related to an open space with 1 device per 50 sq m

GESTIONE DELLA SANIFICAZIONE IN REMOTO, TRAMITE CENTRALE SD LOGICA FM, O IN LOCALE CON APP DEDICATA SANITIZATION MANAGEMENT REMOTELY, VIA SD LOGICA FM CONTROL UNIT, OR LOCALLY WITH A DEDICATED APP

Con l'integrazione delle Centrali SD LGFM è possibile connettere il sistema di sanificazione in rete, tramite il portale NuBe, regolando i principali parametri dell'impianto.

Integrating SD LGFM control units it is possible to connect the sanitization system to the network, by NuBe portal, regulating the main parameters of the sanitization system



**CENTRALE LOGICA
LOGICA CONTROL UNIT**

SD LGFM - Cod. 21102





La APP SanificaAria Beghelli BLE (telecomando in locale Bluetooth) è stata progettata per comandare in locale, con la massima semplicità, il sistema di sanificazione integrato nell'apparecchio.

The SanificaAria Beghelli APP (local Bluetooth remote control) was designed to locally control, with maximum simplicity, the sanitization system integrated into the luminaire.

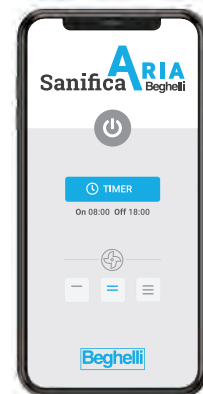

SEGUE / NEXT >

Led Panel RTI SanificaAria

RD FLUSSO-POTENZA REGOLABILI / ADJUSTABLE FLUX-POWER



Flusso/Potenza Flux/Power	Led Panel RTI SanificaAria		
	lm	W	lm/W
STEP 1	5000	36	139
STEP 2	4000	28	142
STEP 3	3400	24	142

Driver RD dotato di switch con 3 step di modulazione della corrente in modo da assicurare la massima efficienza luminosa, e quindi il massimo risparmio energetico, utilizzando solo il flusso luminoso determinato in fase di progettazione

RD driver equipped with a switch with 3 steps of current modulation in order to ensure maximum luminous efficiency, and therefore maximum energy saving, using only the luminous flux determined in the design phase.

VARIANTI SPECIALI - a richiesta / SPECIAL VARIANTS - on request

TEMPERATURA COLORE 3000K e 6000K, 0-10V / COLOUR TEMPERATURE 3000K and 6000K, 0-10V

ACCESSORI - in dotazione / ACCESSORIES - included



FOTOSENSORE DIMMER INTELLIGENTE
SMART DIMMER LIGHT SENSOR



ACCESSORI - da ordinare separatamente / ACCESSORIES - to be ordered separately



RICAMBIO CARTUCCIA SANIFICANTE
SPARE PART PURIFICATION CARTRIDGE
uvOxy® Durata 12 mesi, con utilizzo 24h-giorno
Duration 12 months, at 24h/day use
Cod. **26721**



TRASMETTITORE RADIO SanificaAria
SanificaAria RADIO TRANSMITTER
Controllo radio, di uno o più dispositivi SanificaAria
Radio control SanificaAria devices
Cod. **20104SA**

EMERGENZA CON INVERTER LED - da ordinare separatamente EMERGENCY LED INVERTER - to be ordered separately



INVERTER PLUG&LIGHT SE/SA 1-3h 20-60V

Cod. **19358** (1h)
Cod. **19359** (3h)





INVERTER GL AT/LG AR 15W 55V

Cod. **19391** - batteria LiFe / LiFe battery





INVERTER AT/LG AR 9W 55V

Cod. **19355L** - batteria LiFe / LiFe battery





MODULO EMERGENZA LGFM
LGFM EMERGENCY MODULE
Solo per Inverter della serie AT/LG
For AT/LG series inverters only

Cod. **19375**





INVERTER UNIVERSALE 5W 20-240V

AT - Cod. **19398**
CT - Cod. **19399**





MODULO / MODULE LG - LGFM - DALI
Solo per Inverter CT / For CT Inverters only

LG - Cod. **15079**
LGFM - Cod. **15037**
DALI - Cod. **15080**





CENTRALE LOGICA
LOGICA CONTROL UNIT



SD LGFM - Cod. 21102



TRASMETTITORE RADIO DOMOTICO
HOME AUTOMATION RADIO TRANSMITTER

Cod. 20104



Lens Panel



WEB
CATALOGUE



IP20
IP40

IK05

650°



+40°C
-20°C

CRI>90

UGR<19



Caratteristiche

Mantenimento flusso luminoso a 25°C
60.000h (L80B20)

Installazioni incasso M600, plafone, sospensione

Corpo Lamiera prezincata di acciaio verniciata alle polveri di poliestere RAL 9003

Ottica Lenti in PMMA trasparente

Conformità EN 60598-1, EN60598-2-2, EN 60598-2-22, EN62471 (rischio fotobiologico esente), CAM Criteri Ambientali Minimi secondo DM 11.01.2017, 2014/53/UE, EN60598-2-22

Applicazioni

Terziario, retail, uffici, scuole, ospedali

Characteristics

Luminous flux retention at 25°C
60,000h (L80B20)

Mounting recessed, M600, ceiling, suspended

Housing Polyester powder-coated pre-galvanised sheet steel, RAL 9003

Optics Clear PMMA lenses

Compliance EN 60598-1, EN60598-2-2, EN 60598-2-22, EN62471 (photobiological risk-free), CAM Minimum Environmental Criteria according to DM 11.01.2017, 2014/53/EU

Applications

Services, retail, offices, schools, hospitals

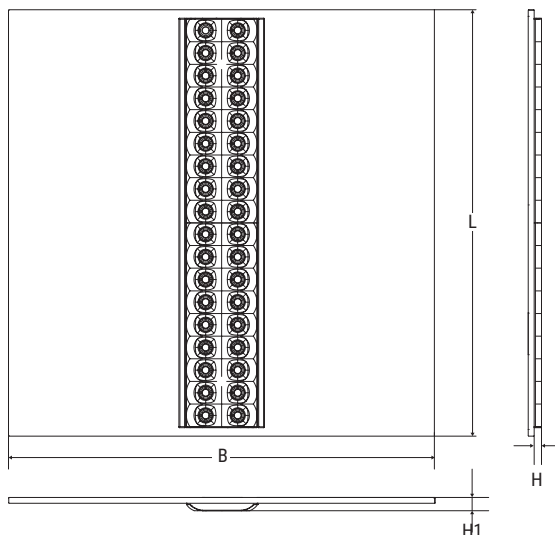

Versione Version		Dimensioni Dimensions mm			
		L	B	H	H1
ED	600x600	595	595	10	27
	300x1200	1196	296	10	27
DALI	600x600	595	595	10	44
	300x1200	1196	296	10	44
SD	600x600	595	595	10	44
	300x1200	1196	296	10	44

LENS PANEL - 600x600

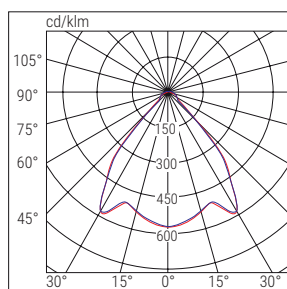

■ C0-C180 ■ C90-C270

LENS PANEL - 300x1200

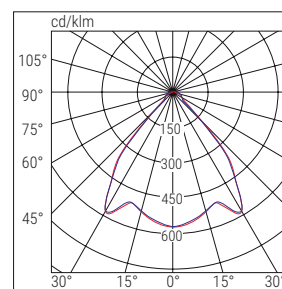

■ C0-C180 ■ C90-C270

	Versione Version	Cod.	Descrizione Description	Potenza Power W	Temp. colore Colour Temp. K	CRI	Flusso LED LED Flux lm (Tj=25°C)	Flusso Flux lm	Efficienza Efficiency lm/W	Kg	Note	
ED	600x600	40131	LENS PAN 418 M600 UGR19 CRI90 ED4K	25	4000	>90	3700	3400	136	3.5	ON / OFF	
	300x1200	40134	LENS PAN 236 300x1200 UGR19 CRI90 ED4K	32	4000	>90	5400	4500	141	3.5		
	300x1200	40137	LENS PAN 258 300x1200 UGR19 CRI90 ED4K	50	4000	>90	7100	6500	130	3.5		
DALI	VERSIONI DALI CODIFICATE / ENCODED DALI VERSIONS: È possibile creare apparecchi DALI integrando la versione SD con l'accessorio Modulo DALI Cod. 15024 It is possible to create DALI luminaires by integrating the SD version with the accessory DALI Module Cod 15024											
												DALI
SD	600x600	40140	LENS PAN 418 M600 UGR19 CRI90 SD 4K	35	4000	>90	4700	4400	126	3.5	☐	AUTODIMMER
	300x1200	40143	LENS PAN 236 300x1200 UGR19 CRI90 SD4K	41	4000	>90	6100	5300	129	3.5	☐	
	300x1200	40146	LENS PAN 258 300x1200 UGR19 CRI90 SD4K	56	4000	>90	7500	7000	125	3.5	☐	

VARIANTI CON DIVERSA TEMPERATURA COLORE (K) / VERSIONS WITH DIFFERENT COLOUR TEMPERATURES (K)

Gli apparecchi sono disponibili anche in versione **3000K e 6000K**. L'elenco dei codici relativi è visionabile nell'**Indice analitico**, in calce ai codici su indicati con 4000K
 The luminaires are also available in **3000K and 6000K** versions. A list of the related codes can be found in the **Analytical Index**, under the above codes with 4000K

ACCESSORI - in dotazione / ACCESSORIES - included



FOTOSENSORE DIMMER INTELLIGENTE
SMART DIMMER LIGHT SENSOR



ACCESSORI - da ordinare separatamente / ACCESSORIES - to be ordered separately



KIT DI SOSPENSIONE
SUSPENDED MOUNTING KIT

Cod. **70100**



CORNICE PLAFONE / CEILING FRAME

Solo versioni SD o abbinato all'inverter Plug&Light SD versions only or combined with the Plug&Light inverter

Cod. **20089** (600x600) - Cod. **20101** (300x1200)

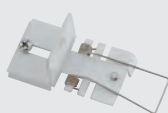

KIT CONTROSOFFITTO
FALSE CEILING KIT

Comprende 4 staffe con 2 differenti tipi di fissaggio
 Included 4 brackets with two type of fixing

Cod. **70039**



KIT CAVETTO DI SICUREZZA
SAFETY CABLE KIT

Cod. **70059**

SEGUE / NEXT >

Lens Panel

SD-X ACCESSORI - da ordinare separatamente / **ACCESSORIES** - to be ordered separately



MODULO RADIO DOMOTICO
HOME AUTOMATION RADIO MODULE

Cod. 15022



MODULO DALI
DALI MODULE

Cod. 15024



MODULO RADIO DOMOTICO ESTERNO
EXTERNAL HOME AUTOMATION RADIO MODULE

TRASMETTITORE / TRANSMITTER - Cod. 20104



MODULO 1÷10V
1÷10V MODULE

Cod. 15034

EMERGENZA CON INVERTER LED - da ordinare separatamente *EMERGENCY LED INVERTER - to be ordered separately*



INVERTER PLUG&LIGHT SE/SA 1-3h 20-60V

Cod. 19358 (1h)
Cod. 19359 (3h)

TR



INVERTER UNIVERSALE 5W 20-240V

AT - Cod. 19398
CT - Cod. 19399

AT CT



INVERTER AT/LG AR
Essenziale per l'installazione Cod. 19376
Essential to mounting Cod. 19376

Cod. 19355L (9W-55V Batt. LiFe)
Cod. 19391 (15W-55V Batt. LiFe)

AT LG



MODULO / MODULE LG - LGFM - DALI
Solo per Inverter CT / *For CT Inverters only*

LG - Cod. 15079
LGFM - Cod. 15037
DALI - Cod. 15080

LG
LGFM
DALI



COVER INVERTER IP65
INVERTER COVER IP65

Cod. 19376

IP65



MODULO LGFM
Solo per Inverter LG
For LG Inverters only

Cod. 19375

LGFM

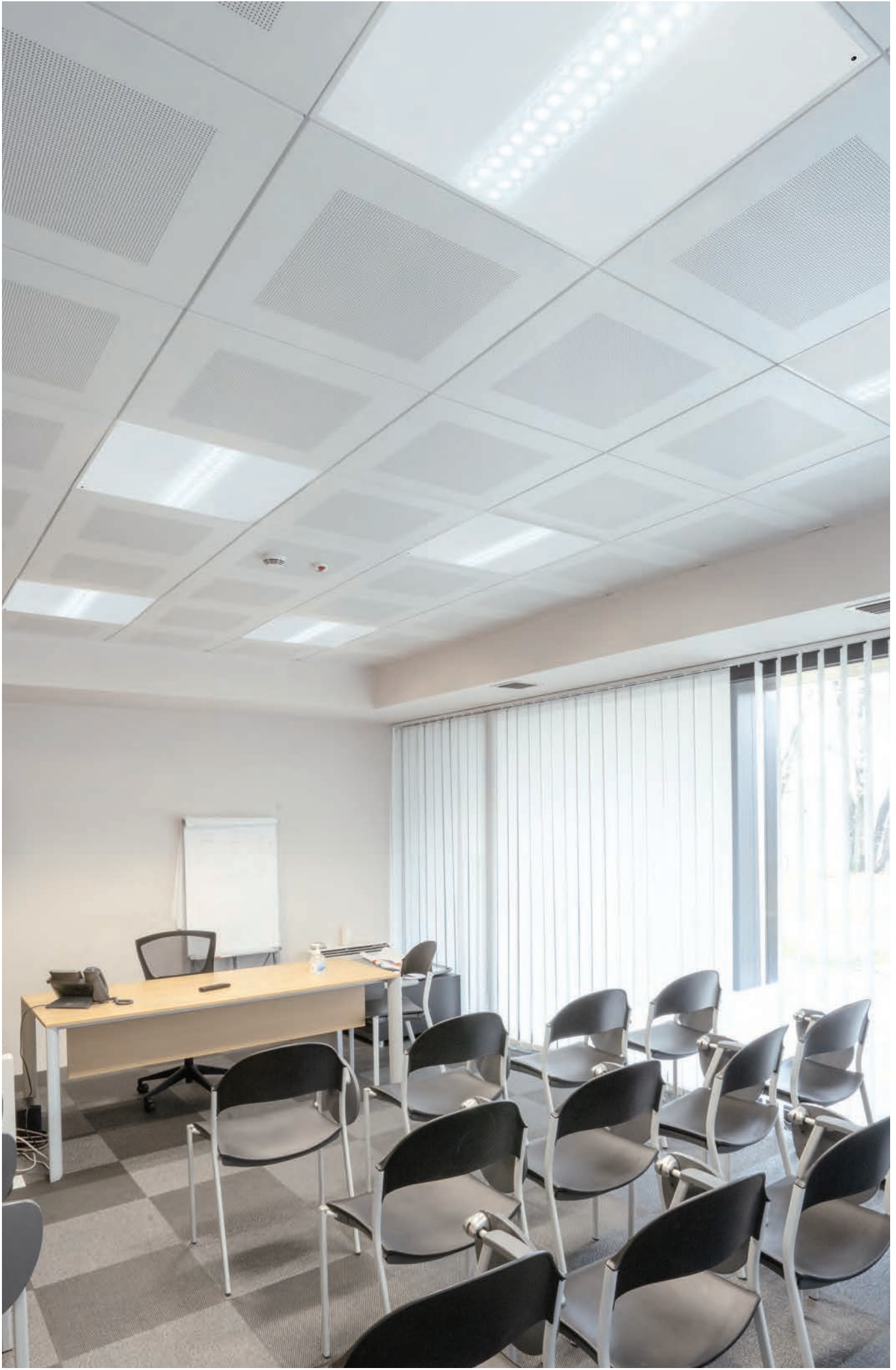

023 incasso e plafone / recessed and ceiling

Led Panel

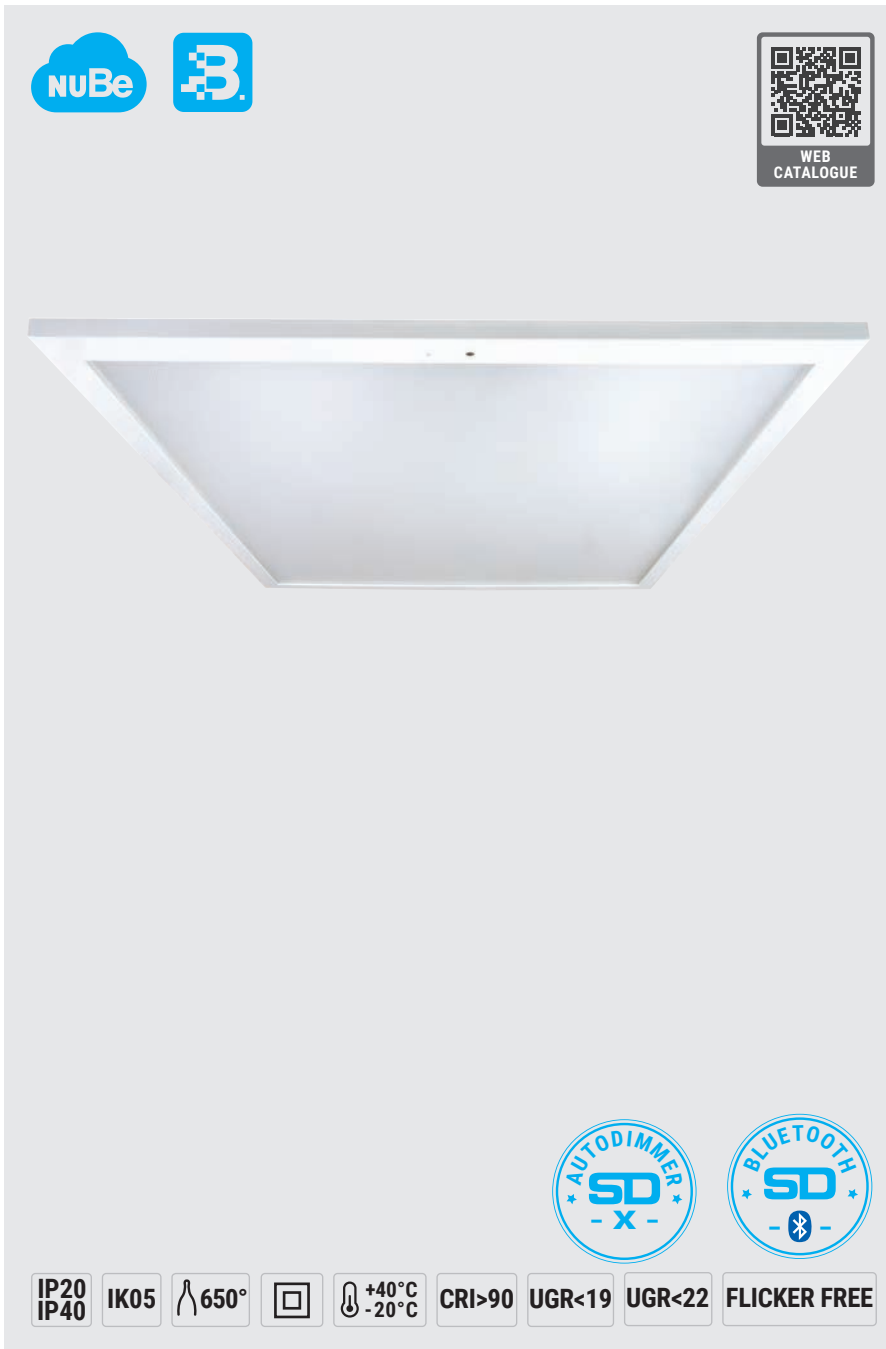

Caratteristiche

Mantenimento flusso luminoso a 25°C
>50.000h (L80B20)

Installazioni incasso M600, plafone, sospensione, cartongesso

Corpo Alluminio bianco

Optica schermo stabilizzato ai raggi UV autoestinguento, microprismatizzato, anti riflesso, guidaluce in PMMA

Conformità EN60598-1, EN60598-2-2, EN60598-2-22, EN62471 (rischio fotobiologico esente), CAM Criteri Ambientali Minimi secondo DM 11.01.2017, 2014/53/UE, EN60598-2-22

Applicazioni

Terziario, retail, uffici, scuole

Characteristics

Luminous flux retention at 25°C
>50,000h (L80B20)

Mounting recessed, M600, ceiling, suspended, plasterboard

Housing Aluminium, white

Optics UV-stabilised, self-extinguishing, micro-prismatic screen, anti-reflective, PMMA light guide

Compliance EN60598-1, EN60598-2-2, EN 60598-2-22, EN62471 (photobiological risk-free), CAM Minimum Environmental Criteria according to DM 11.01.2017, 2014/53/EU

Applications

Services sector, retail, offices, schools

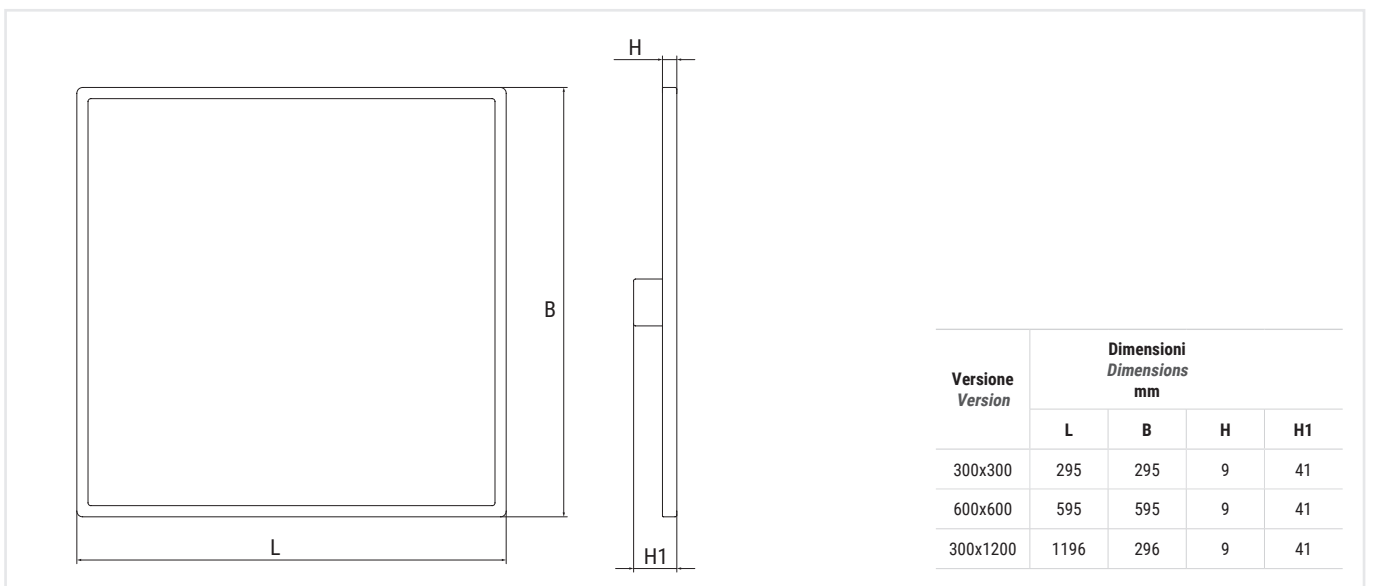

Versione Version	Dimensioni Dimensions mm			
	L	B	H	H1
300x300	295	295	9	41
600x600	595	595	9	41
300x1200	1196	296	9	41

LED PANEL - UGR<19 - CRI>90

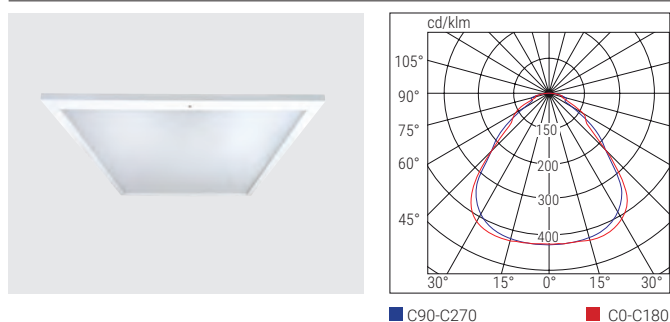

LED PANEL - UGR<19

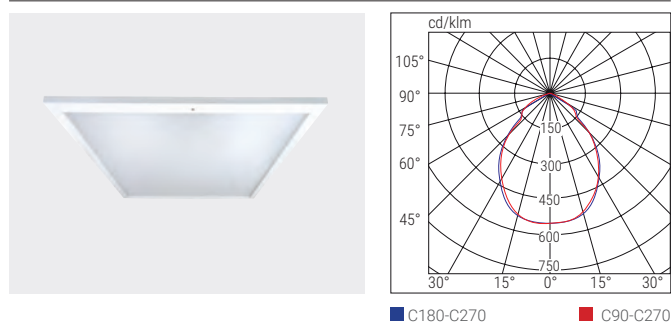

LED PANEL - UGR<22

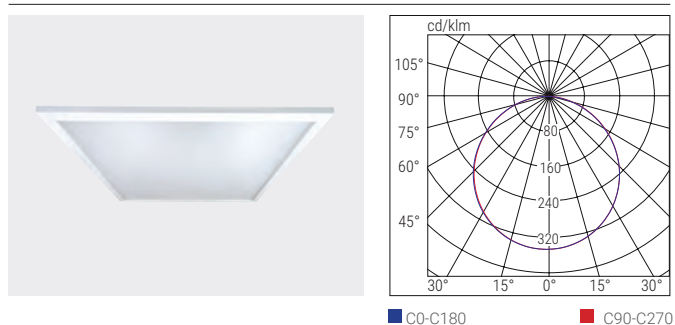

	Versione Version	Cod.	Descrizione Description	Potenza Power W	Temp. colore Colour Temp. K	CRI	Flusso LED LED Flux lm (Tj=25°C)	Flusso Flux lm	Efficienza Efficiency lm/W	Kg	UGR	
ED	300x300	70038	PAN LED 14W 300X300 4K	14	4000	>80	1520	1300	93	0.65	<22	ON / OFF
	600x600	40101	L PAN 418 M600 U19 C90 ED 4K	36	4000	>90	4800	4000	110	3.5	<19	
	600x600	70041	PAN LED 600X600 UGR<19 80LM/W 4K	38	4000	>80	4200	3040	80	3.7	<19	
	600x600	70045	PAN LED 45W 600X600 UGR<19 95LM/W 4K	45	4000	>80	5800	4275	95	3.7	<19	
	600x600	70011	PAN LED 38W 600X600 4K	38	4000	>80	3800	3600	94	3.7	<22	
	600x600	70022	PAN LED 45W 600X600 4K	45	4000	>80	5000	4200	93	3.7	<22	
	1200x300	40104	LED PANEL 30X120 U19 C90 ED 4K	36	4000	>90	4800	4000	110	4.9	<19	
	1200x300	70043	PAN LED 1200x300 UGR<19 80LM/W 4K	38	4000	>80	4200	3040	80	3.7	<19	
	1200x300	70047	PAN LED 45W 1200X300 UGR<19 95LM/W 4K	45	4000	>80	5900	4275	95	3.7	<19	
	1200x300	70013	PAN LED 38W 1200x300 4K	38	4000	>80	3800	3600	94	3.7	<22	
1200x300	70024	PAN LED 45W 1200X300 4K	45	4000	>80	5000	4200	93	3.7	<22		
DALI	600x600	42313	LED PANEL 418 M600 U19 C90 DL 4K	36	4000	>90	4800	4000	110	3.5	<19	DALI
	300x1200	42316	LED PANEL 30X120 U19 C90 DL 4K	36	4000	>90	4800	4000	110	4.9	<19	
SD	600x600	40107	LED PANEL 418 M600 U19 C90 SD 4K	36	4000	>90	4800	4000	110	3.5		AUTODIMMER
	300x1200	40110	LED PANEL 30X120 U19 C90 SD 4K	36	4000	>90	4800	4000	110	4.9		
SD	600x600	42301	LED PANEL 418 M600 U19 C90 SDB 4K	36	4000	>90	4800	4000	110	3.5	<19	BLUETOOTH
	300x1200	42304	LED PANEL 30X120 U19 C90 SDB 4K	36	4000	>90	4800	4000	110	4.9	<19	

VARIANTI CON DIVERSA TEMPERATURA COLORE (K) / VERSIONS WITH DIFFERENT COLOUR TEMPERATURES (K)

Gli apparecchi sono disponibili anche in versione **3000K e 6000K**. L'elenco dei codici relativi è visionabile nell'**Indice analitico**, in calce ai codici su indicati con 4000K
The luminaires are also available in **3000K and 6000K** versions. A list of the related codes can be found in the **Analytical Index**, under the above codes with 4000K

SEGUE / NEXT >

025 incasso e plafone / recessed and ceiling

Led Panel

ACCESSORI - da ordinare separatamente / ACCESSORIES - to be ordered separately



KIT DI SOSPENSIONE
SUSPENDED MOUNTING KIT

Cod. **70033**



CORNICE PLAFONE / CEILING FRAME

Cod. **20097** - 600x600, h30
Cod. **20100** - 300x1200, h30
Cod. **20089** - 600x600, h70 emergenza/emergency
Cod. **20101** - 300x1200, h70 emergenza/emergency



STAFFE CARTONGESSO
PLASTERBOARD BRACKETS
4 pezzi / 4 pieces

Cod. **70049**

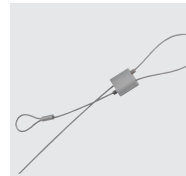

KIT CAVETTO DI SICUREZZA
SAFETY CABLE KIT

Cod. **70059**

SD-X ACCESSORI - da ordinare separatamente / ACCESSORIES - to be ordered separately

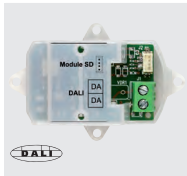

MODULO DALI
DALI MODULE

Cod. **15024**

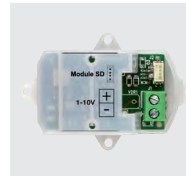

MODULO 1÷10V
1÷10V MODULE

Cod. **15034**



MODULO RADIO DOMOTICO
HOME AUTOMATION RADIO MODULE

Cod. **15022**

SD ACCESSORI - da ordinare separatamente / ACCESSORIES - to be ordered separately



CENTRALE LOGICA
LOGICA CONTROL UNIT

SD LGFM - Cod. Ord. **21102**



MODULI AUTODIMMER/RADIO
AUTODIMMER/RADIO MODULES

AUTODIMMER - Cod. **15053**
AUTODIMMER + RADIO - Cod. **15054**



CONCENTRATORE WIFI BLUETOOTH
WiFi BLUETOOTH CONCENTRATOR
1 ingresso di controllo / 1 control input

Cod. **15064**



MODULO INTERFACCIA BLUETOOTH
BLUETOOTH MODULE INTERFACE
3 ingressi di controllo / 3 control inputs

Cod. **15065**

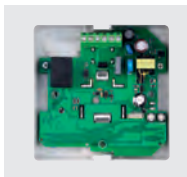

CONCENTRATORE BLUETOOTH EASY BOX
BLUETOOTH EASY BOX CONCENTRATOR

WiFi - Cod. **15174**
WiFi ETHERNET - Cod. **15074**



SENSORE PRESENZA
MOTION SENSOR

INDUSTR IP65 - Cod. **15063**
UFFICI IP40 - Cod. **15062**

Sistema di trasmissione wireless integrato che permette la comunicazione fra gli apparecchi in modo da realizzare gruppi che attuano gli stessi comandi senza aggiungere ulteriori cablaggi. Utilizzando il Modulo interfaccia Bluetooth è possibile comandare i gruppi in modalità wireless. Per gestire un impianto centralizzato da APP B.connect occorre integrare il Concentratore Bluetooth. Integrated wireless transmission system for communication between luminaires in order to create groups with the same commands without adding further wiring. Using the Bluetooth Interface Module it is possible to control the groups wireless. To manage a centralized system from the B.connect APP, the Bluetooth concentrator must be integrated.

EMERGENZA CON INVERTER LED - da ordinare separatamente
EMERGENCY LED INVERTER - to be ordered separately



INVERTER PLUG&LIGHT SE/SA 1-3h 20-60V

Cod. **19358** (1h)
 Cod. **19359** (3h)

TR



INVERTER UNIVERSALE 5W 20-240V

AT - Cod. **19398**
 CT - Cod. **19399**

AT CT



INVERTER AT/LG AR

Cover inverter (19376) necessaria per l'installazione
 Inverter cover (19376) required for installation

Cod. **19355L** (9W-55V Batt. LiFe)
 Cod. **19391** (15W-55V Batt. LiFe)

AT LG



MODULO / MODULE LG - LGFM - DALI

Solo per Inverter CT / For CT Inverters only

LG - Cod. **15079**
 LGFM - Cod. **15037**
 DALI - Cod. **15080**

LG

LGFM

DALI



COVER INVERTER IP65
INVERTER COVER IP65

Cod. **19376**

IP65



MODULO EMERGENZA LGFM
LGFM EMERGENCY MODULE

Solo per Inverter della serie AT/LG
 For AT/LG series inverters only

Cod. **19375**

LGFM



027 incasso e plafone / recessed and ceiling

Backlight Panel

illuminazione / lighting

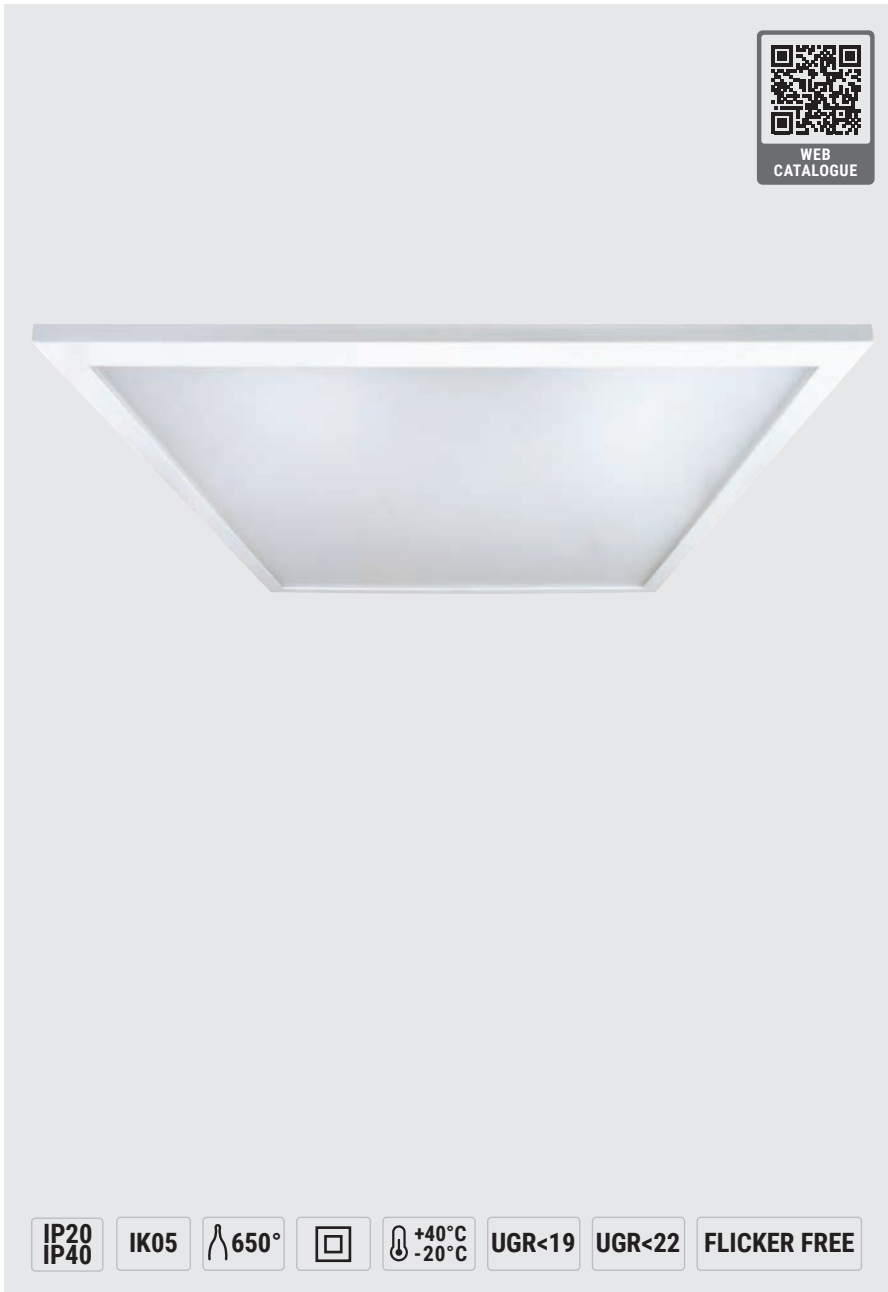

Caratteristiche

Mantenimento flusso luminoso a 25°C
>30.000h (L80B20)

Installazioni Incasso, plafone, sospensione

Corpo Alluminio verniciato bianco

Schermo PMMA stabilizzato ai raggi UV autoestinguente, prismaticizzato

Conformità EN60598-1, EN60598-2-2, EN 62471

Applicazioni

Terziario, retail, uffici, scuole

Characteristics

Luminous flux retention at 25°C
>30.000h (L80B20)

Mounting recessed, ceiling, suspended

Housing Aluminium, white

Screen UV-stabilised PMMA, self-extinguishing,

Compliance EN60598-1, EN60598-2-2, EN 62471

Applications

Services sector, retail, offices, schools

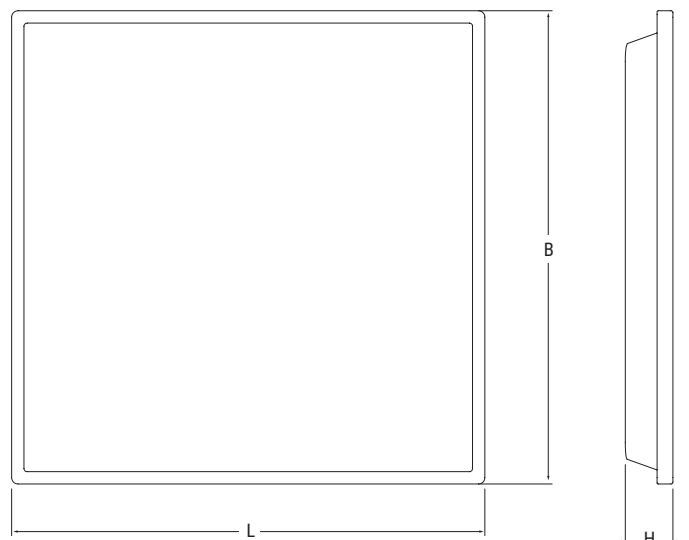

Versione Version		Dimensioni Dimensions mm		
		L	B	H
UGR<19	600x600	596	596	31
	300x1200	295	1195	31
UGR<22	600x600	596	596	31
	300x1200	295	1195	31

BACKLIGHT PANEL UGR<19

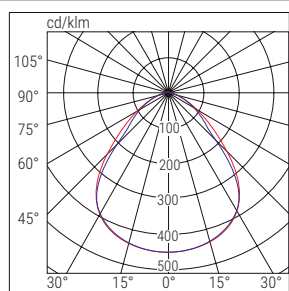

■ C180-C270 ■ C90-C270

BACKLIGHT PANEL

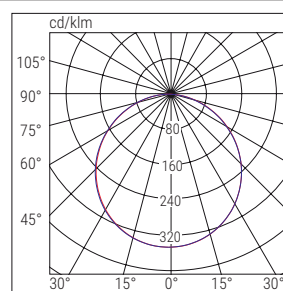

■ C180-C270 ■ C90-C270

Version Version	Cod.	Descrizione Description	Potenza Power W	Temp. colore Colour Temp. K	CRI	Flusso LED LED Flux lm (Tj=25°C)	Flusso Flux lm	Efficienza Efficiency lm/W	Kg	Note Notes
LED	600x600	70084 BACKLIGHT UGR19 36W 600X600 3K	36	3000	>80	4500	3600	100	2.4	UGR<19
	600x600	70085 BACKLIGHT UGR19 36W 600X600 4K	36	4000	>80	4500	3600	100	2.4	UGR<19
	300x1200	70086 BACKLIGHT UGR19 LED 36W 30X120 3K 95LM/W 3K	36	3000	>80	4500	3600	100	2.4	UGR<19
	300x1200	70087 BACKLIGHT UGR19 LED 36W 30X120 4K 95LM/W 4K	36	4000	>80	4500	3600	100	2.4	UGR<19
	600x600	70090 BACKLIGHT UGR19 40W 600X600 3K	40	3000	>80	5400	4500	110	2.4	UGR<19
	600x600	70091 BACKLIGHT UGR19 40W 600X600 4K	40	4000	>80	5400	4500	110	2.4	UGR<19
	600x600	70080 BACKLIGHT LED 36W 600X600 3K	36	3000	>80	4500	3600	100	2.4	UGR<22
	600x600	70081 BACKLIGHT LED 36W 600X600 4K	36	4000	>80	4500	3600	100	2.4	UGR<22
	300x1200	70082 BACKLIGHT LED 36W 30X120 3K	36	3000	>80	4500	3600	100	2.4	UGR<22
	300x1200	70083 BACKLIGHT LED 36W 30X120 4K	36	4000	>80	4500	3600	100	2.4	UGR<22
	600x600	70088 BACKLIGHT LED 40W 600x600 3K	40	3000	>80	5400	4500	110	2.4	UGR<22
	600x600	70089 BACKLIGHT LED 40W 600x600 4K	40	4000	>80	5400	4500	110	2.4	UGR<22

ACCESSORI - da ordinare separatamente / ACCESSORIES - to be ordered separately

**CORNICE PLAFONE
CEILING FRAME**

Cod. **20089** (600x600 h 70)
Cod. **20101** (300x1200 h 70)

**CAVI DI SOSPENSIONE
SUSPENSION WIRE**

Cod. **70033**

**STAFFE CARTONGESSO
PLASTER BOARD BRACKETS**

4 pezzi / 4 pieces

Cod. **70049**

EMERGENZA CON INVERTER LED - da ordinare separatamente EMERGENCY LED INVERTER - to be ordered separately

INVERTER PLUG&LIGHT SE/SA 1-3h 20-60V

Cod. **19358** (1h)
Cod. **19359** (3h)

TR

INVERTER UNIVERSALE 5W 20-240V

AT - Cod. **19398**
CT - Cod. **19399**

AT CT

MODULO / MODULE LG - LGFM - DALI
Solo per Inverter CT / For CT Inverters only

LG - Cod. **15079**
LGFM - Cod. **15037**
DALI - Cod. **15080**

LG
LGFM
DALI

Clinic Panel



WEB
CATALOGUE



IP65

IK05

650°

+40°C
-20°C

CRI>90

UGR<19



Caratteristiche

Mantenimento flusso luminoso a 25°C
>50.000h (L80B20)

Installazioni incasso, plafone, cartongesso

Corpo Lamiera di acciaio zincata e verniciata alle polveri RAL 9003 opaco

Optica vetro temprato/lastra in metacrilato anti riflesso, secondo la versione

Conformità EN60598-1, EN60598-2-2, EN60598-2-22, EN62471 (rischio fotobiologico esente), CAM secondo DM 11.01.2017, 2014/53/UE, EN60598-2-22

Applicazioni

Ospedali, laboratori biologici e sale operatorie, ambienti ad elevata umidità dell'aria.

Characteristics

Luminous flux retention at 25°C
>50.000h (L80B20)

Mounting recessed, ceiling, plasterboard

Housing Polyester powder-coated pre-galvanised sheet metal, RAL 9003

Optics tempered glass or anti-reflection methacrylate sheet, according the versions

Compliance EN60598-1, EN60598-2-2, EN60598-2-22, EN62471 (photobiological risk exempt), CAM in according to DM 11.01.2017, 2014/53/UE, EN60598-2-22

Applications

Hospitals, biological laboratories and Operating rooms

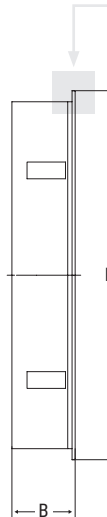
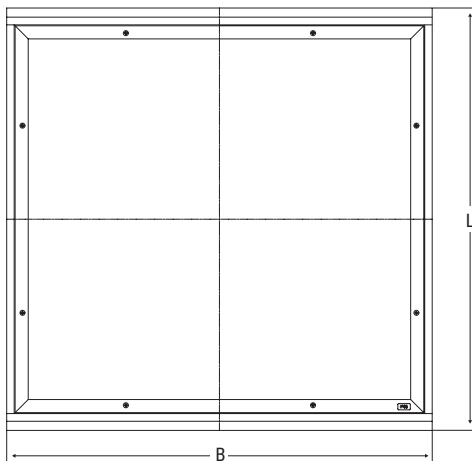

SPESSORE CONTROSOFFITTO
CEILING THICKNESS
da 12,5 a 55,5 mm

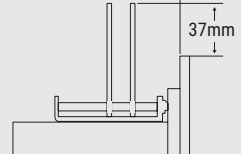

Versione Version	Dimensioni Dimensions mm			
	L	B	H	Foro incasso Recessed hole
Incasso	599	599	102	565x565
Plafone	677	682	96	-

INCASSO / RECESSED

PLAFONE / CEILING

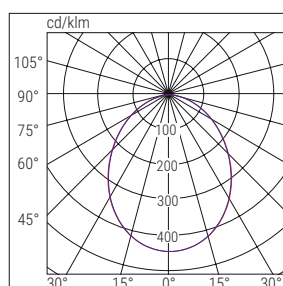
OTTICA VETRO/OPT. GLASS

■ C90-C270 ■ C0-C180

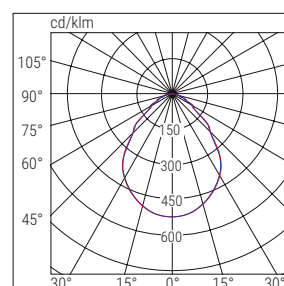
OTTICA PMMA/OPT. PMMA

■ C90-C270 ■ C0-C180

CLINIC PANEL INCASSO / RECESSED

	Optica Optics	Cod.	Descrizione Description	Potenza Power W	Temp. colore Colour Temp. K	CRI	Flusso LED LED Flux lm (Tj=25°C)	Flusso Flux lm	Efficienza Efficiency lm/W	Kg	
ED	Metacrilato	41131	CLINIC P M600 PM ED IP65 4K	47	4000	>80	6200	5400	115	5.5	ON / OFF
	Vetro temp.	41134	CLINIC P M600 SG ED IP65 4K	47	4000	>80	6000	5150	110	5.5	
	Metacrilato	41163	CLINIC M600 C90 PM ED IP65 4K	47	4000	>90	5900	5100	109	5.5	
	Vetro temp.	41166	CLINIC M600 C90 SG ED IP65 4K	47	4000	>90	5600	4900	104	5.5	
DALI	Metacrilato	41501	CLINIC P M600 PM DL IP65 4K	47	4000	>80	6200	5400	115	5.5	DALI
	Vetro temp.	41504	CLINIC P M600 SG DL IP65 4K	47	4000	>80	6000	5150	110	5.5	
	Metacrilato	41513	CLINIC M600 C90 PM DL IP65 4K	47	4000	>90	5900	5100	109	5.5	
	Vetro temp.	41516	CLINIC M600 C90 SG DL IP65 4K	47	4000	>90	5600	4900	104	5.5	
SD	Metacrilato	41271	CLINIC P M600 PM SDB IP65 4K	47	4000	>80	6200	5400	115	5.5	BLUETOOTH
	Vetro temp.	41274	CLINIC P M600 SG SDB IP65 4K	47	4000	>80	6000	5150	110	5.5	
	Metacrilato	41283	CLINIC M600 C90 PM SDB IP65 4K	47	4000	>90	5900	5100	109	5.5	
	Vetro temp.	41286	CLINIC M600 C90 SG SDB IP65 4K	47	4000	>90	5600	4900	104	5.5	

CLINIC PANEL PLAFONE / CEILING









	Optica Optics	Cod.	Descrizione Description	Potenza Power W	Temp. colore Colour Temp. K	CRI	Flusso LED LED Flux lm (Tj=25°C)	Flusso Flux lm	Efficienza Efficiency lm/W	Kg	
ED	Metacrilato	41137	CLINIC P PLAFO PM ED IP65 4K	47	4000	>80	6600	5700	121	6	ON / OFF
	Vetro temp.	41140	CLINIC P PLAFO SG ED IP65 4K	47	4000	>80	6200	5400	115	6	
	Metacrilato	41169	CLINIC PLAFO C90 PM ED IP65 4K	47	4000	>90	6200	5400	115	6	
	Vetro temp.	41172	CLINIC PLAFO C90 SG ED IP65 4K	47	4000	>90	5900	5100	109	6	
DALI	Metacrilato	41507	CLINIC P PLAFO PM DL IP65 4K	47	4000	>80	6600	5700	121	6	DALI
	Vetro temp.	41510	CLINIC P PLAFO SG DL IP65 4K	47	4000	>80	6200	5400	115	6	
	Metacrilato	41519	CLINIC PLAFO C90 PM DL IP65 4K	47	4000	>90	6200	5400	115	6	
	Vetro temp.	41522	CLINIC PLAFO C90 SG DL IP65 4K	47	4000	>90	5900	5100	109	6	
SD	Metacrilato	41277	CLINIC P PLAFO PM SDB IP65 4K	47	4000	>80	6600	5700	121	6	BLUETOOTH
	Vetro temp.	41280	CLINIC P PLAFO SG SDB IP65 4K	47	4000	>80	6200	5400	115	6	
	Metacrilato	41289	CLINIC PLAF C90 PM SDB IP65 4K	47	4000	>90	6200	5400	115	6	
	Vetro temp.	41292	CLINIC PLAF C90 SG SDB IP65 4K	47	4000	>90	5900	5100	109	6	

SEGUE / NEXT >



031 incasso e plafone / recessed and ceiling

Clinic Panel

SD  **ACCESSORI** - da ordinare separatamente / **ACCESSORIES** - to be ordered separately

	<p>CENTRALE LOGICA <i>LOGICA CONTROL UNIT</i></p> <p>SD LGFM - Cod. 21102</p>		<p>MODULI AUTODIMMER/RADIO <i>AUTODIMMER/RADIO MODULES</i></p> <p>AUTODIMMER - Cod. 15053 AUTODIMMER + RADIO - Cod. 15054</p>
	<p>CONCENTRATORE WIFI BLUETOOTH <i>WiFi BLUETOOTH CONCENTRATOR</i> 1 ingresso di controllo / 1 control input</p> <p>Cod. 15064 </p>		<p>MODULO INTERFACCIA BLUETOOTH <i>BLUETOOTH MODULE INTERFACE</i> 3 ingressi di controllo / 3 control inputs</p> <p>Cod. 15065 </p>
	<p>CONCENTRATORE BLUETOOTH EASY BOX <i>BLUETOOTH EASY BOX CONCENTRATOR</i></p> <p>WiFi - Cod. 15174 WiFi ETHERNET - Cod. 15074 </p>		<p>SENSORE PRESENZA <i>MOTION SENSOR</i></p> <p>INDUSTR IP65 - Cod. 15063 UFFICI IP40 - Cod. 15062</p>

APPARECCHIO + EMERGENZA CON INVERTER LED PRECABLATO - codifica componibile LUMINAIRE + EMERGENCY WITH PRE-WIRED LED INVERTER - modular coding

INVERTER INTEGRATO <i>BUILT-IN INVERTER</i>	DESINENZA <i>SUFFIX</i>	SISTEMA DI EMERGENZA <i>EMERGENCY SYSTEM</i>	AUTONOMIA (h) <i>AUTONOMY (h)</i>	POTENZA LED (W) <i>LED POWER (W)</i>
	TR1	TR	1	3
	TR3	TR	3	3
	AT	AT	1/1.5/2/3/8	5/3.3/2.5/1.7/0.7
	CT	CT	1/1.5/2/3/8	5/3.3/2.5/1.7/0.7

	<p>MODULO / MODULE LG - LGFM - DALI Solo per Inverter CT / For CT Inverters only</p> <p>LG - Cod. 15079 LGFM - Cod. 15037 DALI - Cod. 15080</p>		<p>BOOSTER BATTERY (AT - CT version) 1 Batteria - Raddoppia Potenza 10W e Flusso emergenza 2 Batteria - Triplica Potenza 15W e Flusso emergenza 1 Battery - Double Power 10W and emergency Flux 2 Battery - Triple Power 15W and emergency Flux</p> <p>Cod. RA13</p>
---	--	--	--

Ogni apparecchio di questa serie può essere **configurato e precablato direttamente in Beghelli**, già pronto per l'installazione. Per ordinarlo è necessario creare il codice specificando il sistema di controllo utilizzando come segue le presenti tabelle: **Cod. APPARECCHIO + DESINENZA**, per esempio per ordinare un apparecchio in versione CentralTest (CT) occorre aggiungere al Cod. 41131 la desinenza CT = Cod. 41131CT

*Each unit in this series can be **configured and pre-wired directly in Beghelli**, ready for installation. For orders, create the code by specifying the control system using the following tables: **Cod. LUMINAIRE + SUFFIX**, for example, to order an CentralTest (CT) luminaire, add to the Cod. 41131 the suffix CT = Cod. 41131CT*



Installazione a tenuta per Camere bianche o Sale operatorie / Sealed installation for clean rooms or operating rooms

Guarnizione frontale posta sul retro della cornice esterna che non permette la fuoriuscita di polveri dal controsoffitto. Per l'utilizzo in controsoffitto a tenuta con pannelli metallici si consiglia il montaggio di una guarnizione adesiva perimetrale (non fornita) sul fianco dei pannelli circostanti l'apparecchio. *Front gasket placed on the back of the external frame does not allow dust to escape from the false ceiling. For use in a sealed false ceiling with metal panels, we recommend mounting an outer perimeter adhesive gasket (not provided) on the side of the panels surrounding the appliance.*



P236/258



Caratteristiche

Mantenimento flusso luminoso a 25°C
>70.000h (L80B20)

Installazioni Plafone, sospensione

Corpo Lamiera prezinata verniciata alle polveri di poliestere RAL 9003

Ottica Lamellare tipo Dark light

Conformità EN 60598-1, EN 60598-2-2, EN 60598-2-22, EN 62471 (Rischio biologico esente), 2014/53/UE, EN60598-2-22

Applicazioni

Terziario, retail, uffici, scuole

Characteristics

Luminous flux retention at 25°C
>70,000h (L80B20)

Mounting ceiling, suspended

Housing Polyester powder-coated pre-galvanised sheet steel, RAL 9003

Optics Dark light blades

Compliance EN 60598-1, EN 60598-2-2, EN 60598-2-22, EN 62471 (biological risk-free) 2014/53/EU

Applications

Services sector, retail, offices, schools

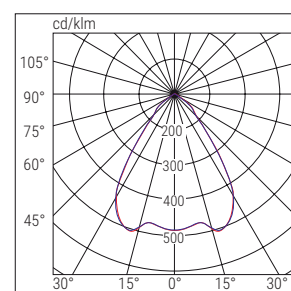

■ C90-C270
■ C0-C180

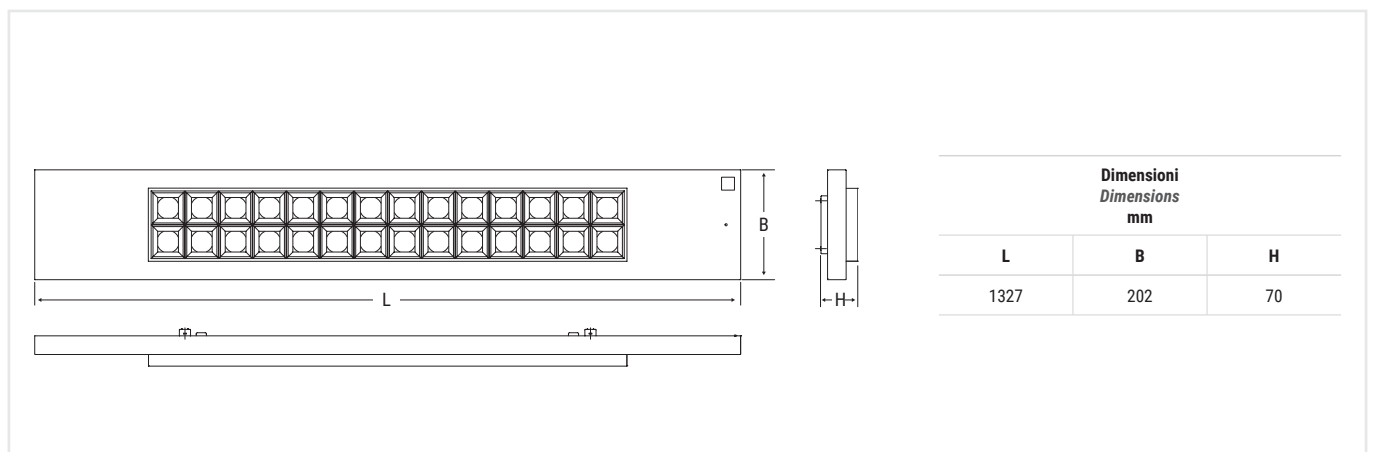

	Cod.	Descrizione Description	Potenza Power W	Temp. colore Colour Temp. K	CRI	Flusso LED LED Flux lm (Tj=25°C)	Flusso Flux lm	Efficienza Efficiency lm/W	Kg	Note
RD	42358	PLAFONE LED 2X36 RD 4K C90	35	4000	>90	5200	4467	126	4.6	REGOLABILE
	42359	PLAFONE LED 2X58 RD 4K C90	53	4000	>90	7400	6435	121	4.6	
DALI	42346	PLAFONE LED 2X36 DL 4K C90	35	4000	>90	5200	4467	126	4.6	DALI
	42347	PLAFONE LED 2X58 DL 4K C90	53	4000	>90	7400	6435	121	4.6	
SD	42334	PLAFONE LED 2X36 SDB 4K C90	35	4000	>90	5200	4467	126	4.6	BLUETOOTH
	42335	PLAFONE LED 2X58 SDB 40K C90	53	4000	>90	7400	6435	121	4.6	

RD FLUSSO-POTENZA REGOLABILI / ADJUSTABLE FLUX-POWER

	Flusso/Potenza Flux/Power	2x36W			2x58W		
		lm	W	lm/W	lm	W	lm/W
STEP 1	4467	35	126	6435	53	121	
STEP 2	3971	31	128	5996	49	123	
STEP 3	3430	27	129	5770	47	124	
STEP 4	3200	22	144	5310	40	133	

Driver RD dotato di switch con 4 step di modulazione della corrente in modo da assicurare la massima efficienza luminosa, e quindi il massimo risparmio energetico, utilizzando solo il flusso luminoso determinato in fase di progettazione

RD driver equipped with a switch with 4 steps of current modulation in order to ensure maximum luminous efficiency, and therefore maximum energy saving, using only the luminous flux determined in the design phase.

ACCESSORI - da ordinare separatamente / ACCESSORIES - to be ordered separately

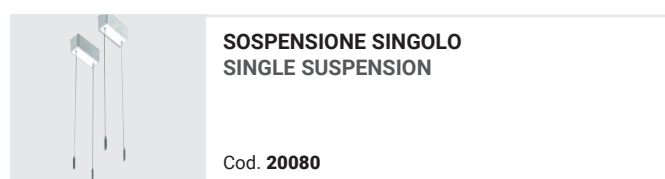

P236/258

EMERGENZA CON INVERTER LED - da ordinare separatamente EMERGENCY LED INVERTERS - to be ordered separately



INVERTER PLUG&LIGHT SE/SA 1-3h 20-60V

Cod. 19358 (1h)
Cod. 19359 (3h)

TR



INVERTER GL AT/LG AR 15W 55V

Cod. 19391 Batteria LiFe / LiFe battery

AT LG



INVERTER AT/LG AR 9W 55V

Cod. 19355L Batteria LiFe / LiFe battery

AT LG



MODULO EMERGENZA LGFM

Solo per Inverter della serie AT/LG
For AT/LG series inverters only

Cod. 19375

LGFM



INVERTER UNIVERSALE 5W 20-240V

AT - Cod. 19398
CT - Cod. 19399

AT CT



MODULO / MODULE LG - LGFM - DALI

Solo per Inverter CT / For CT Inverters only

LG - Cod. 15079
LGFM - Cod. 15037
DALI - Cod. 15080

LG

LGFM

DALI



BOOSTER BATTERY

Batteria LiFe 6.4V 1,5Ah - Raddoppia la Potenza (10W) e il Flusso luminoso (1600lm) in emergenza
LiFe 6.4V 1,5Ah Battery - Double the Power (10W) and the Emergency Flux (1600lm)

Cod. RA13

SD ACCESSORI - da ordinare separatamente / ACCESSORIES - to be ordered separately



CENTRALE LOGICA LOGICA CONTROL UNIT

SD LGFM - Cod. 21102



MODULI AUTODIMMER/RADIO AUTODIMMER/RADIO MODULES

AUTODIMMER - Cod. 15053
AUTODIMMER + RADIO - Cod. 15054



CONCENTRATORE WIFI BLUETOOTH WiFi BLUETOOTH CONCENTRATOR

1 ingresso di controllo / 1 control input

Cod. 15064



MODULO INTERFACCIA BLUETOOTH BLUETOOTH MODULE INTERFACE

3 ingressi di controllo / 3 control inputs

Cod. 15065



CONCENTRATORE BLUETOOTH EASY BOX BLUETOOTH EASY BOX CONCENTRATOR

WiFi - Cod. 15174
WiFi ETHERNET - Cod. 15074



SENSORE PRESENZA MOTION SENSOR

INDUSTR IP65 - Cod. 15063
UFFICI IP40 - Cod. 15062

Sistema di trasmissione wireless integrato che permette la comunicazione fra gli apparecchi in modo da realizzare gruppi che attuano gli stessi comandi senza aggiungere ulteriori cablaggi. Utilizzando il Modulo interfaccia Bluetooth è possibile comandare i gruppi in modalità wireless. Per gestire un impianto centralizzato da APP B.connect occorre integrare il Concentratore Bluetooth. Integrated wireless transmission system for communication between luminaires in order to create groups with the same commands without adding further wiring. Using the Bluetooth Interface Module it is possible to control the groups wireless. To manage a centralized system from the B.connect APP, the Bluetooth concentrator must be integrated.



037 incasso e plafone / recessed and ceiling

Full Moon



WEB CATALOGUE



IP44

IK05

850°

+40°C
-20°C

ANTI BLACK-OUT



Caratteristiche

Mantenimento flusso luminoso a 25°C

>30.000h (L80B20)

Installazioni Plafone, parete

Corpo PC stabilizzato ai raggi UV

autoestinguento

Schermo PC stabilizzato ai raggi UV

autoestinguento, opalino

Conformità EN60598-1, EN60598-2-1,

EN60598-2-22, EN62471

Applicazioni

Residenziale, terziario, rampe di scale,

terrazzi, porticati

Characteristics

Luminous flux retention at 25°C

>30.000h (L80B20)

Mounting Ceiling, wall

Housing UV stabilised PC self-

extinguishing

Screen UV stabilised opal PC self-

extinguishing

Compliance EN60598-1, EN60598-2-1,

EN60598-2-22, EN62471

Applications

Residential, services sector, stairways,

terraces, arcades

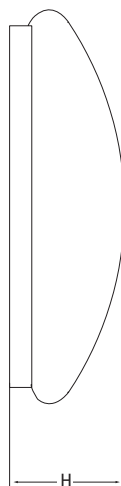
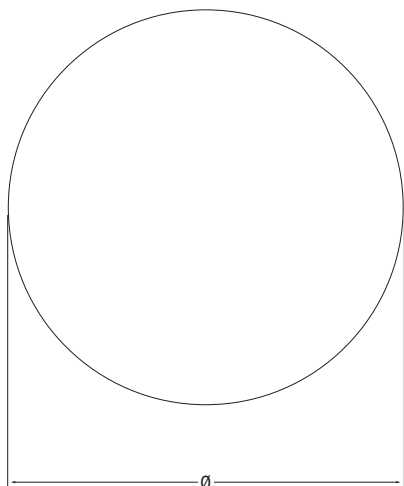

Versione Version	W	Dimensioni Dimensions mm	
		Ø	H
ON-OFF	18	328	77
	24	380	90
ANTI BLACK-OUT 1h	18	328	77
	24	380	90
EMERGENZA / EMERGENCY 3h	18, 24	323	95
EMERGENZA / EMERGENCY 3h Motion sensor	18	328	77
	24	380	90

FULL MOON 18W

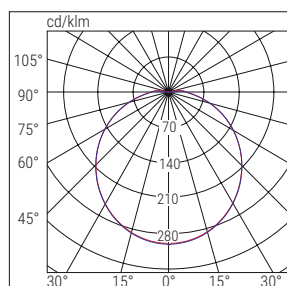

■ C180-C270 ■ C90-C270

FULL MOON 24W

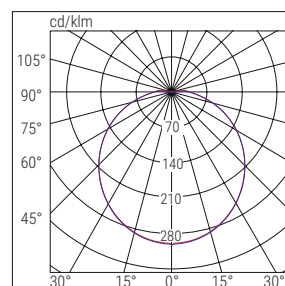

■ C0-C180 ■ C90-C270

Cod.	Descrizione Description	Vers. Version	Autonomia Autonomy h	Potenza Power W	Temp. colore Colour Temp. K	CRI	Flusso LED LED Flux lm (Tj=25°C)	Flusso Flux lm	Flusso emergenza Emergency Flux lm	Kg	Note Notes
75330	FULLMOON OPAL TUTTOSCHERM 18W 3K			18	3000	>80	1700	1440		0.48	
75331	FULLMOON OPAL TUTTOSCHERM 18W 4K			18	4000	>80	1700	1440		0.48	
75332	FULLMOON OPAL TUTTOSCHERM 24W 3K			24	3000	>80	2300	1920		0.69	
75333	FULLMOON OPAL TUTTOSCHERM 24W 4K			24	4000	>80	2300	1920		0.69	
75334	FULLMOON SENS TUTTOSCHERM 18W 3K			18	3000	>80	1700	1440		0.53	ON / OFF
75335	FULLMOON SENS TUTTOSCHERM 18W 4K			18	4000	>80	1700	1440		0.53	ON / OFF
75336	FULLMOON SENS TUTTOSCHERM 24W 3K			24	3000	>80	2300	1920		0.74	ON / OFF
75337	FULLMOON SENS TUTTOSCHERM 24W 4K			24	4000	>80	2300	1920		0.74	ON / OFF
75338	FULLMOON EMERG TUTTOSCHER 18W 3K	SA/SE	1.5	18	3000	>80	1700	1440	50	0.57	ANTI-BLACK-OUT
75339	FULLMOON EMERG TUTTOSCHER 18W 4K	SA/SE	1.5	18	4000	>80	1700	1440	50	0.57	ANTI-BLACK-OUT
75344	FULLMOON EMERG TUTTOSCHER 24W 3K	SA/SE	1.5	24	3000	>80	2300	1920	50	0.78	ANTI-BLACK-OUT
75345	FULLMOON EMERG TUTTOSCHER 24W 4K	SA/SE	1.5	24	4000	>80	2300	1920	50	0.78	ANTI-BLACK-OUT
75346	FULL MOON EMERG 3h 18W 3K	SA/SE	3	18	3000	>80	1700	1440	240	0.57	EMERGENZA
75347	FULL MOON EMERG 3h 18W 4K	SA/SE	3	18	4000	>80	1700	1440	240	0.57	EMERGENZA
75348	FULL MOON EMERG 3h 24W 3K	SA/SE	3	24	3000	>80	2300	1920	240	0.78	EMERGENZA
75349	FULL MOON EMERG 3h 24W 4K	SA/SE	3	24	4000	>80	2300	1920	240	0.78	EMERGENZA
75360	FULL MOON EMERG 3h SENS 18W 3K	SA/SE	3	18	3000	>80	1700	1440	240	0.57	ON / OFF
75361	FULL MOON EMERG 3h SENS 18W 4K	SA/SE	3	18	4000	>80	1700	1440	240	0.57	ON / OFF
75362	FULL MOON EMERG 3h SENS 24W 3K	SA/SE	3	24	3000	>80	2300	1920	240	0.78	ON / OFF
75363	FULL MOON EMERG 3h SENS 24W 4K	SA/SE	3	24	4000	>80	2300	1920	240	0.78	ON / OFF

039 incasso e plafone / recessed and ceiling

Full Moon Ring



IP65

IK07

650°

 +40°C
-10°C

Caratteristiche

Mantenimento flusso luminoso a 25°C
>30.000h (L80B20)

Installazioni Plafone, parete

Corpo Polycarbonato

Schermo Polycarbonato finitura opale

Conformità EN60598-1, EN60598-2-2,
EN 62471

Applicazioni

Residenziale, rampe di scale, terrazzi,
porticati

Characteristics

Luminous flux retention at 25°C
>30.000h (L80B20)

Mounting Ceiling, wall

Housing Polycarbonate

Screen opal Polycarbonate

Compliance EN60598-1, EN60598-2-2,
EN 62471

Applications

Residential, services sector, fstairways,
terraces, arcades

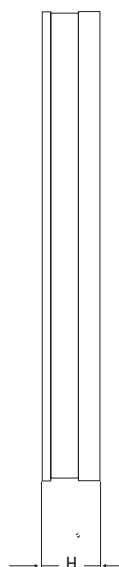
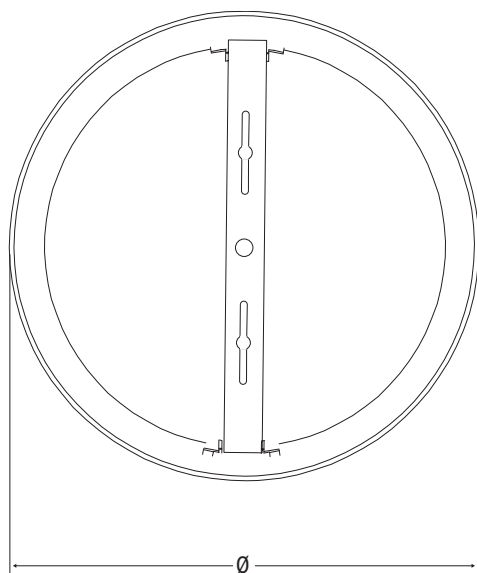

W	Dimensioni Dimensions mm	
	Ø	H
16	200	55
26	300	55
40	400	55

FULL MOON RING 16W

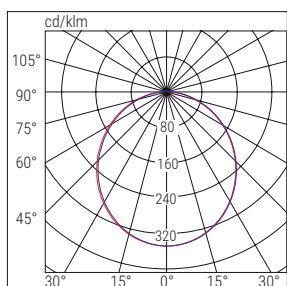
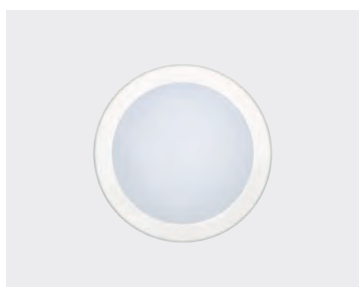

■ C180-C270 ■ C90-C270

FULL MOON RING 26W

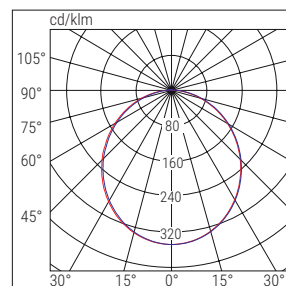
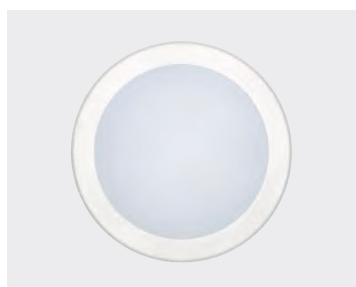

■ C180-C270 ■ C90-C270

FULL MOON RING 40W

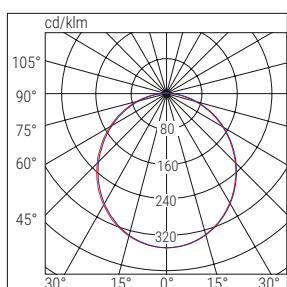

■ C180-C270 ■ C90-C270

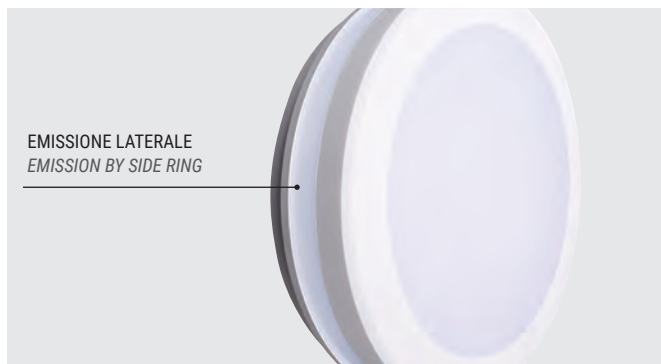

	Cod.	Descrizione Description	Potenza Power W	Temp. colore Colour Temp. K	CRI	Flusso LED LED Flux lm (Tj=25°C)	Flusso Flux lm	Efficienza Efficiency lm/W	Kg	Note Notes
ED	75364	FULL MOON RING IP65 16W 4K	16	4000	>80	1600	1280	80	0.4	
	75365	FULL MOON RING IP65 26W 4K	26	4000	>80	2450	2080	80	0.8	
	75366	FULL MOON RING IP65 40W 4K	40	4000	>80	3650	3200	80	1.3	

ON / OFF

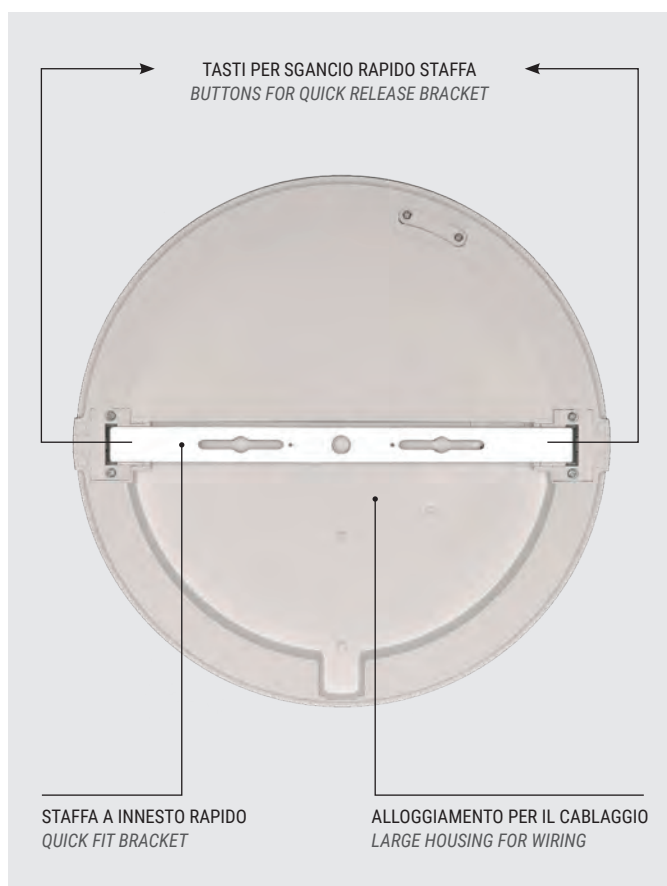



Caratteristiche

Mantenimento flusso luminoso a 25°C
>30.000h (L70B50)

Installazioni Plafone, parete

Corpo PC stabilizzato ai raggi UV autoestingente

Schermo PC stabilizzato ai raggi UV autoestingente, opalino

Colore Bianco, nero

Conformità EN60598-1, EN60598-2-1, EN62471

Applicazioni

Residenziale, terziario, rampe scale, terrazzi, porticati, aree di accesso esterne di negozi, alberghi e ristoranti.

Characteristics

Luminous flux retention at 25°C
>30.000h (L70B50)

Mounting Ceiling, wall

Housing UV stabilised PC self-extinguishing

Screen UV stabilised PC opal self-extinguishing

Colore White, black

Compliance EN60598-1, EN60598-2-1, EN62471

Applications

Residential, services sector, fstairways, terraces, arcades, external access areas for shops, hotels and restaurants

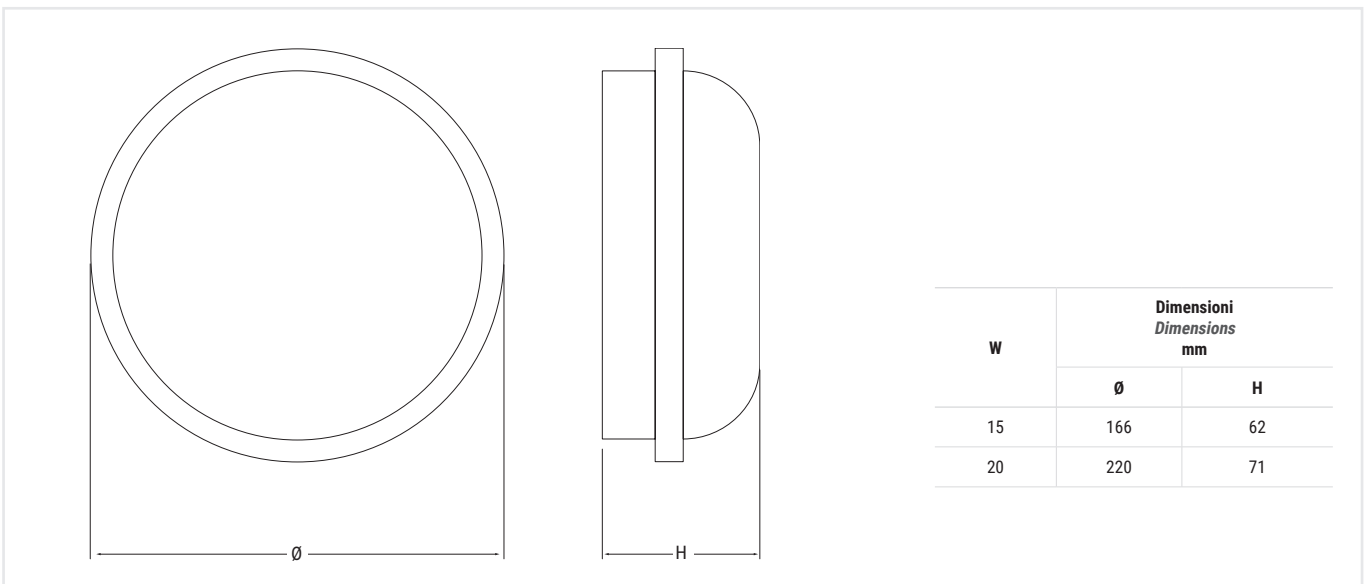

GEOLED 15W

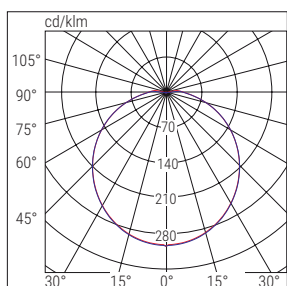

■ C180-C270 ■ C90-C270

GEOLED 20W

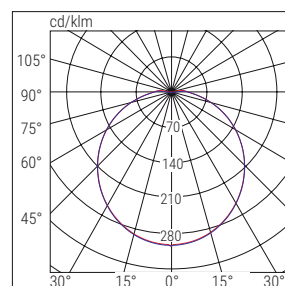

■ C0-C180 ■ C90-C270



VERSIONE NERA BLACK VERSION

VANO DI CABLAGGIO RAPIDO

Morsetti alloggiati in un vano posteriore con coperchio stagno per il mantenimento del grado di protezione IP65

QUICK WIRING BOX

Terminal block enclosed in rear compartment equipped with a watertight door in order to maintain the IP65 protection degree.

	Cod.	Descrizione Description	Potenza Power W	Temp. colore Colour Temp. K	CRI	Flusso LED LED Flux lm (Tj=25°C)	Flusso Flux lm	Efficienza Efficiency lm/W	Kg	Colore Color
ED	75324	GEO LED 15W ROUND BLACK 3K	15	3000	>80	2025	1250	83	0.28	●
	75325	GEO LED 15W ROUND BLACK 4K	15	4000	>80	2025	1250	83	0.28	●
	75327	GEO LED 20W ROUND BLACK 4K	20	4000	>80	2700	1650	83	0.43	●
	75320	GEO LED 15W ROUND WHITE 3K	15	3000	>80	2025	1250	83	0.28	○
	75322	GEO LED 20W ROUND WHITE 3K	20	3000	>80	2700	1650	83	0.43	○
	75321	GEO LED 15W ROUND WHITE 4K	15	4000	>80	2025	1250	83	0.28	○
	75323	GEO LED 20W ROUND WHITE 4K	20	4000	>80	2700	1650	83	0.43	○

ON / OFF

ACCESSORI - in dotazione / ACCESSORIES - included

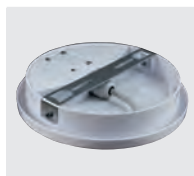

STAFFA DI FISSAGGIO
CEILING MOUNTING BRACKET



PRESSACAVO PG9
CABLE GLAND PG9

GeoLed Lite

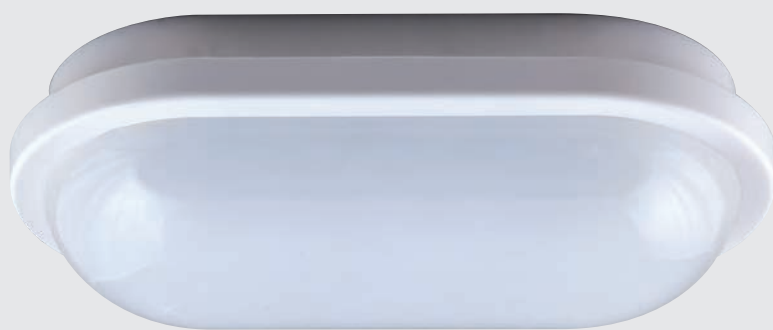

IP65

IK05

850°

 +40°C
-20°C

Caratteristiche

Mantenimento flusso luminoso a 25°C
>30.000h (L70B50)

Installazioni Plafone, parete

Corpo Policarbonato stabilizzato ai raggi UV autoestingente

Schermo Policarbonato stabilizzato ai raggi UV autoestingente, opalino

Colore Bianco, nero

Conformità EN60598-1, EN60598-2-1, EN62471

Applicazioni

Residenziale, terziario, rampe scale, terrazzi, porticati, aree di accesso esterne di negozi, alberghi e ristoranti.

Characteristics

Luminous flux retention at 25°C
>30.000h (L70B50)

Mounting Ceiling, wall

Housing UV stabilised PC self-extinguishing

Screen UV stabilised PC opal self-extinguishing

Compliance EN60598-1, EN60598-2-1, EN62471

Applications

Residential, services, stairways, terraces, arcades, external access areas for shops, hotels and restaurants

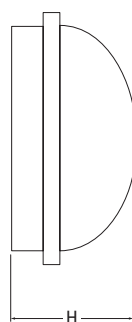
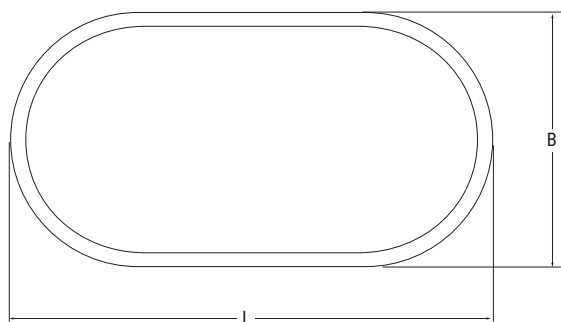

W	Dimensioni Dimensions mm		
	L	B	H
15	214	114	63
20	269	145	74

GEOLED LITE 15W

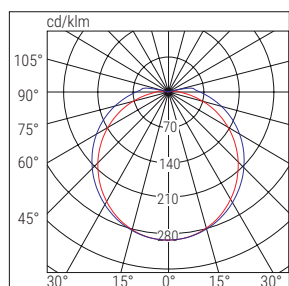

■ C180-C270 ■ C90-C270

GEOLED LITE 20W

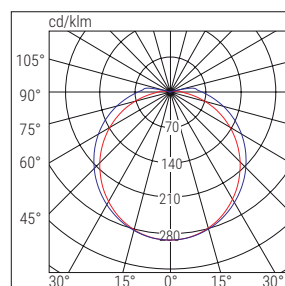

■ C0-C180 ■ C90-C270



VERSIONE NERA BLACK VERSION

VANO DI CABLAGGIO RAPIDO

Morsettiera alloggiata in un vano posteriore con coperchio stagno per il mantenimento del grado di protezione IP65

QUICK WIRING BOX

Terminal block enclosed in rear compartment equipped with a watertight door in order to maintain the IP65 protection degree.

	Cod.	Descrizione Description	Potenza Power W	Temp. colore Colour Temp. K	CRI	Flusso LED LED Flux lm (Tj=25°C)	Flusso Flux lm	Efficienza Efficiency lm/W	Kg	Colore Color
LED	75425	GEO LED 15W OVAL BLACK 4K	15	4000	>80	2025	1250	83	0.28	●
	75427	GEO LED 20W OVAL BLACK 4K	20	4000	>80	2700	1650	83	0.43	●
	75420	GEO LED 15W OVAL WHITE 3K	15	3000	>80	2025	1250	83	0.28	○
	75422	GEO LED 20W OVAL WHITE 3K	20	3000	>80	2340	1650	83	0.43	○
	75421	GEO LED 15W OVAL WHITE 4K	15	4000	>80	2025	1250	83	0.28	○
	75423	GEO LED 20W OVAL WHITE 4K	20	4000	>80	2340	1650	83	0.43	○

ACCESSORI - in dotazione / ACCESSORIES - included



STAFFA DI FISSAGGIO
CEILING MOUNTING BRACKET



PRESSACAVO PG9
CABLE GLAND PG9

RegLed CCT

illuminazione / lighting



Caratteristiche

Mantenimento flusso luminoso a 25°C
>30.000h (L80B20)

Installazioni Plafone, parete, sottopensile

Corpo Policarbonato

Ottica Semidiffondente, simmetrica

Schermo PC finitura opale

Colore Bianco

Conformità EN60598-1, EN60598-2-1, EN 62471

Applicazioni

Residenziale, retail, sottopensile, vetrine

Characteristics

Luminous flux retention at 25°C
>30.000h (L80B20)

Mounting Ceiling, wall, under cabinet

Housing PC

Screen opal PC

Colour White

Compliance EN60598-1, EN60598-2-1, EN62471

Applications

Residential, retail, under cabinet, showcases

IP20

IK05

850°



+40°C
-20°C

CCT

046

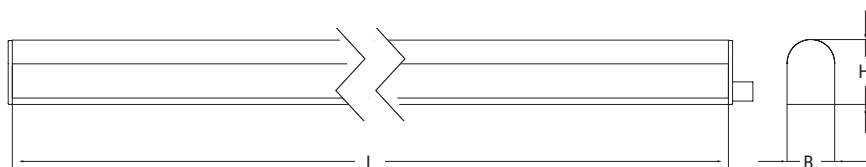

W	N° max moduli in serie max N° module continuous row	Dimensioni Dimensions mm		
		L	B	H
4	10	313	22	30
8	10	573	22	30
10	10	873	22	30
14	10	1173	22	30
18	10	1473	22	30



REGOLAZIONE CCT A BORDO APPARECCHIO

La Temperatura colore è selezionabile su 3 posizioni con lo specifico interruttore: 3000, 4000, 5000K. Un'emissione luminosa appropriata per ogni applicazione, cambiando la CCT di uno stesso apparecchio in opera

CCT ADJUSTMENT ON THE LUMINAIRE

The color temperature can be selected on 3 positions with the specific switch: 3000, 4000, 5000K. An appropriate light output for each application by changing the CCT of the same device on site



FILA CONTINUA SENZA INTERRUZIONE DI LUCE

La connessione Maschio/Femmina fra gli apparecchi evita che si percepisca visivamente l'interruzione di luce in corrispondenza della giunzione.

CONTINUOUS ROW WITHOUT LIGHT INTERRUPTION

The Male/Female connection between the luminaires avoid the interruption of light in the junction point.

Accoppiamento Maschio-Femmina
ad ingombro ridotto
*Reduced dimensions Male-Female
connection*



	Cod.	Descrizione Description	Potenza Power W	Temp. colore Colour Temp. K	CRI	Flusso LED LED Flux lm (Tj=25°C)	Flusso Flux lm	Efficienza Efficiency lm/W	Kg
LED	74075	REGLED CCT 4W 313MM I	4	CCT 3000-4000-5000	>80	460	380	85	0.1
	74076	REGLED CCT 8W 573MM I	8	CCT 3000-4000-5000	>80	920	760	85	0.16
	74077	REGLED CCT 10W 873MM I	10	CCT 3000-4000-5000	>80	1150	950	90	0.21
	74078	REGLED CCT 14W 1173MM I	14	CCT 3000-4000-5000	>80	1610	1330	88	0.28
	74079	REGLED CCT 18W 1473MM I	18	CCT 3000-4000-5000	>80	2070	1710	93	0.28

ACCESSORI - in dotazione / ACCESSORIES - included



**CAVO ALIMENTAZIONE
POWER CABLE**
Lunghezza 1200 mm / Length 1200 mm
Cod. **424020006**



**STAFFE DI FISSAGGIO A SOFFITTO
CEILING FIXING BRACKETS**
2 staffe / 2 brackets
Cod. **424020004**



**CAVO COLLEGAMENTO PER FILA CONTINUA
CONTINUOUS ROW CABLE CONNECTION**
Lunghezza 200 mm / Length 200 mm
Cod. **424020003**



**STAFFE DI FISSAGGIO A PARETE
WALL FIXING BRACKETS**
2 staffe / 2 staffe
Cod. **424020004**

ACCESSORI - da ordinare separatamente / ACCESSORIES - to be ordered separately



**CAVO COLLEGAMENTO PER FILA CONTINUA
CONTINUOUS ROW CABLE CONNECTION**
Cod. **424020005** (1500 mm)
Cod. **424020009** (Lunghezza 2000 mm)

RegLed ECO

illuminazione / lighting



Caratteristiche

Mantenimento flusso luminoso a 25°C
>30.000h (L80B20)

Installazioni Plafone, parete, sottopensile

Corpo PC

Ottica Semidiffondente, simmetrica

Schermo PC finitura opale

Colore Bianco

Conformità EN60598-1, EN60598-2-1, EN 62471

Applicazioni

Residenziale, retail, sottopensile, vetrine

Characteristics

Luminous flux retention at 25°C
>30.000h (L80B20)

Mounting Ceiling, wall, under cabinet

Housing PC

Screen opal PC

Colour White

Compliance EN60598-1, EN60598-2-1, EN62471

Applications

Residential, retail, under cabinet, showcases

IP20

IK05

850°



+40°C
-20°C

048

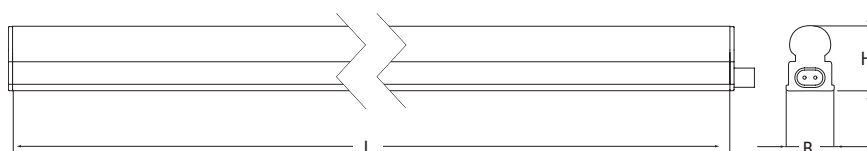

W	N° max moduli in serie max N° module in seires	Dimensioni Dimensions mm		
		L	B	H
4	10	313	22	30
8	10	573	22	30
10	10	873	22	30
14	10	1173	22	30
18	10	1473	22	30



FILA CONTINUA SENZA INTERRUZIONE DI LUCE

La connessione Maschio/Femmina fra gli apparecchi evita che si percepisca visivamente l'interruzione di luce in corrispondenza della giunzione.

CONTINUOUS ROW WITHOUT LIGHT INTERRUPTION

The Male/Female connection between the luminaires avoid the interruption of light in the junction point.

Accoppiamento Maschio-Femmina
ad ingombro ridotto / Male-Female
mating with reduced dimensions



Cod.	Descrizione Description	Potenza Power W	Temp. colore Colour Temp. K	CRI	Flusso LED LED Flux lm (Tj=25°C)	Flusso Flux lm	Efficienza Efficiency lm/W	Kg
74040	RGL P LED 4W 313MM 3000K I	4	3000	≥80	460	380	75	0.1
74042	RGL P LED 8W 573MM 3000K I	8	3000	≥80	920	760	75	0.16
74044	RGL P LED 10W 873MM 3000K I	10	3000	≥80	1150	950	79	0.21
74046	RGL P LED 14W 1173MM 3000K I	14	3000	≥80	1610	1330	78	0.28
74048	RGL P LED 18W 1473MM 3000K I	18	3000	≥80	2070	1710	82	0.34
74041	RGL P LED 4W 313MM 4000K I	4	4000	≥80	480	400	80	0.1
74043	RGL P LED 8W 573MM 4000K I	8	4000	≥80	960	800	80	0.16
74045	RGL P LED 10W 873MM 4000K I	10	4000	≥80	1200	1000	84	0.21
74047	RGL P LED 14W 1173MM 4000K I	14	4000	≥80	1680	1400	83	0.28
74049	RGL P LED 18W 1473MM 4000K I	18	4000	≥80	2160	1800	87	0.34

ACCESSORI - in dotazione / ACCESSORIES - included



**CAVO ALIMENTAZIONE
POWER CABLE**
Lunghezza 1200 mm / Length 1200 mm
Cod. **424020006**



**STAFFE DI FISSAGGIO A SOFFITTO
CEILING FIXING BRACKETS**
2 staffe / 2 brackets
Cod. **424020004**



**CAVO COLLEGAMENTO PER FILA CONTINUA
CONTINUOUS ROW CABLE CONNECTION**
Lunghezza 200 mm / Length 200 mm
Cod. **424020003**



**STAFFE DI FISSAGGIO A PARETE
WALL FIXING BRACKETS**
2 staffe / 2 brackets
Cod. **424020004**

ACCESSORI - da ordinare separatamente / ACCESSORIES - to be ordered separately



**CAVO COLLEGAMENTO PER FILA CONTINUA
CONTINUOUS ROW CABLE CONNECTION**
Cod. **424020005** (1500 mm)
Cod. **424020009** (Lunghezza 2000 mm)

Downlight System



IP20
IP54

IK05

850°

+40°C
-20°C

CRI>90

75°

55°

45°



Caratteristiche

Mantenimento flusso luminoso a 25°C
>50.000h (L70B20)

Installazioni incasso, cartongesso

Corpo Alluminio pressofuso

Ottica PMMA

Schermo 75° con filtro incluso, 55° con filtro smontato, 45° riflettore speculare

Riflettore Policarbonato con varie finiture e trattamenti superficiali

Conformità EN60598-1, EN60598-2-2, EN60598-2-22, EN 62471, CAM Criteri Ambientali Minimi secondo DM 11.01.2017, 2014/53/UE, EN60598-2-22

Applicazioni

Terziario, civile, hotel, scuole, ospedali

Characteristics

Luminous flux retention at 25°C

>50,000h (L70B20)

Mounting recessed, plasterboard

Housing die-cast Aluminium

Optics PMMA

Screen 75° with light filter, 55° without light filter, 45° with specular reflector

Compliance EN60598-1, EN60598-2-2, EN60598-2-22, EN 62471, CAM Criteri Ambientali Minimi secondo DM 11.01.2017, 2014/53/UE, EN60598-2-22

Applications

Residential, services sector, hotels, schools, hospitals

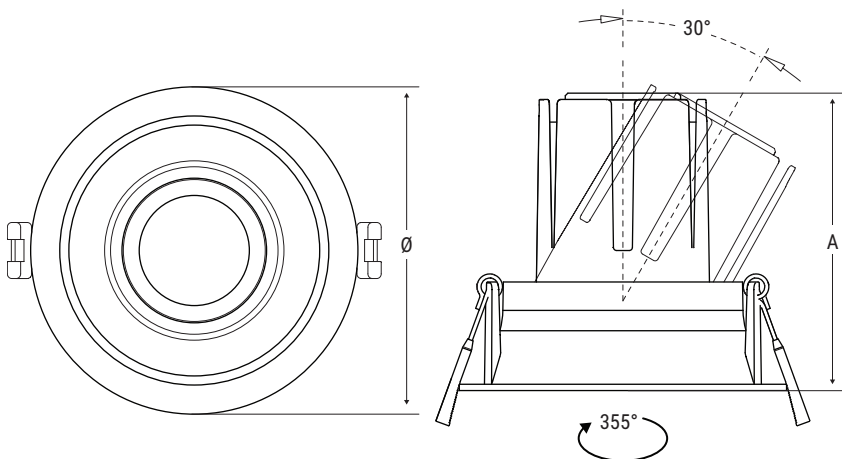

W	Dimensioni Dimensions mm		Foro incasso Recessed hole mm Ø
	A	Ø	
15	95	104	95
24	117	125	110
32	138	145	130
42	152	165	150

75° CON FILTRO / WITH LIGHT FILTER

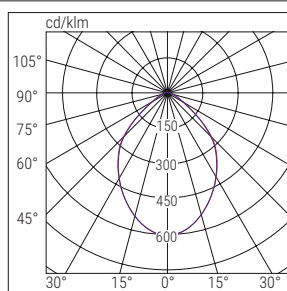

■ C90-C270 ■ C0-C180

Gruppo alimentatore e

sorgente LED dotato di dissipatore in alluminio e ottica lenticolare

Power supply unit and LED source equipped with aluminum heat sink and lenticular optics



55° SENZA FILTRO / WITHOUT FILTER

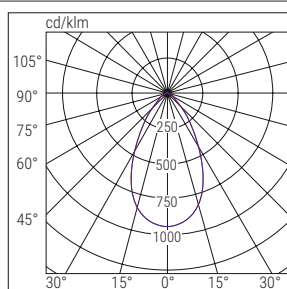

■ C90-C270 ■ C0-C180

Corpo apparecchio

con sistema di fissaggio e telaio mobile per inclinare il fascio fino a 30°

Luminaire body with fixing system and adjustable frame to tilt the beam up to 30°



45° RIFLETT. SPECULARE / SPECULAR REFLECTOR

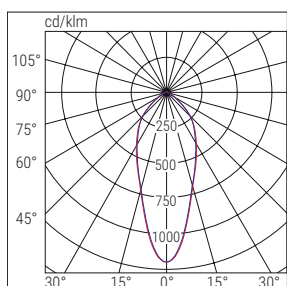

■ C90-C270 ■ C0-C180

Riflettore:

Titanio lucido Metal
satinato - Metal
speculare - Bianco
opaco

Reflector

Polished titanium
Satin metal - Specular metal - Matt white



Cod.	Descrizione Description	Potenza Power W	Temp. colore Colour Temp. K	CRI	Flusso LED LED Flux lm (Tj=25°C)	Flusso Flux lm	Efficienza Efficiency lm/W	Kg	Note
OTTICA SATINATA / SATIN OPTICS									
40330	DWL 15W 75° C90 SAT RD 4K	15	4000	>90	1900	1650	110	0.4	
40331	DWL 24W 75° C90 SAT RD 4K	24	4000	>90	3100	2640	110	0.7	
40332	DWL 32W 75° C90 SAT RD 4K	32	4000	>90	4100	3500	110	1	
40333	DWL 41W 75° C90 SAT RD 4K	41	4000	>90	5200	4510	110	1.4	
40360	DWL 15W 75° C90 SAT RD 3K	15	3000	>90	1900	1600	105	0.4	
40361	DWL 24W 75° C90 SAT RD 3K	24	3000	>90	3000	2600	105	0.7	
40362	DWL 32W 75° C90 SAT RD 3K	32	3000	>90	4000	3400	105	1	
40363	DWL 41W 75° C90 SAT RD 3K	41	3000	>90	5000	4300	105	1.4	

RD

REGOLABILE

051 downlight

Downlight System

Cod.	Descrizione Description	Potenza Power W	Temp. colore Colour Temp. K	CRI	Flusso LED LED Flux lm (Tj=25°C)	Flusso Flux lm	Efficienza Efficiency lm/W	Kg	Note Notes
------	----------------------------	-----------------------	-----------------------------------	-----	--	----------------------	----------------------------------	----	---------------

RD									
OTTICA BIANCA / WHITE OPTICS									
40334	DWL 15W 75° C90 IP54 BIANCO RD 4K	15	4000	>90	1900	1650	110	0.4	
40335	DWL 24W 75° C90 IP54 BIANCO RD 4K	24	4000	>90	3100	2640	110	0.7	
40336	DWL 32W 75° C90 IP54 BIANCO RD 4K	32	4000	>90	4100	3500	110	1	
40337	DWL 41W 75° C90 IP54 BIANCO RD 4K	41	4000	>90	5200	4510	110	1.4	
40364	DWL 15W 75° C90 IP54 BIANCO RD 3K	15	3000	>90	1900	1600	105	0.4	
40365	DWL 24W 75° C90 IP54 BIANCO RD 3K	24	3000	>90	3000	2600	105	0.7	
40366	DWL 32W 75° C90 IP54 BIANCO RD 3K	32	3000	>90	4000	3400	105	1	
40367	DWL 41W 75° C90 IP54 BIANCO RD 3K	41	3000	>90	5000	4300	105	1.4	
OTTICA SPECULARE / SPECULAR OPTICS									
40388	DWL 15W 45° C90 IP54 BRILLA RD 4K	15	4000	>90	1900	1650	110	0.4	
40389	DWL 24W 45° C90 IP54 BRILLA RD 4K	24	4000	>90	3100	2640	110	0.7	
40390	DWL 32W 45° C90 IP54 BRILLA RD 4K	32	4000	>90	4100	3500	110	1	
40391	DWL 41W 45° C90 IP54 BRILLA RD 4K	41	4000	>90	5200	4510	110	1.4	
40440	DWL 15W 45° C90 IP54 BRILLA RD 3K	15	3000	>90	1900	1600	105	0.4	
40441	DWL 24W 45° C90 IP54 BRILLA RD 3K	24	3000	>90	3000	2600	105	0.7	
40442	DWL 32W 45° C90 IP54 BRILLA RD 3K	32	3000	>90	4000	3400	105	1	
40443	DWL 41W 45° C90 IP54 BRILLA RD 3K	41	3000	>90	5000	4300	105	1.4	

DALI									
OTTICA SATINATA / SATIN OPTICS									
40340	DWL 15W 75° C90 IP54 SAT DL 4K	15	4000	>90	1900	1650	110	0.4	
40341	DWL 24W 75° C90 IP54 SAT DL 4K	24	4000	>90	3100	2640	110	0.7	
40342	DWL 32W 75° C90 IP54 SAT DL 4K	32	4000	>90	4100	3500	110	1	
40343	DWL 41W 75° C90 IP54 SAT DL 4K	41	4000	>90	5200	4510	110	1.4	
40370	DWL 15W 75° C90 IP54 SAT DL 3K	15	3000	>90	1900	1600	105	0.4	
40371	DWL 24W 75° C90 IP54 SAT DL 3K	24	3000	>90	3000	2600	105	0.7	
40372	DWL 32W 75° C90 IP54 SAT DL 3K	32	3000	>90	4000	3400	105	1	
40373	DWL 41W 75° C90 IP54 SAT DL 3K	41	3000	>90	5000	4300	105	1.4	
OTTICA BIANCA / WHITE OPTICS									
40344	DWL 15W 75° C90 IP54 BIANCO DL 4K	15	4000	>90	1900	1650	110	0.4	
40345	DWL 24W 75° C90 IP54 BIANCO DL 4K	24	4000	>90	3100	2640	110	0.7	
40346	DWL 32W 75° C90 IP54 BIANCO DL 4K	32	4000	>90	4100	3500	110	1	
40347	DWL 41W 75° C90 IP54 BIANCO DL 4K	41	4000	>90	5200	4510	110	1.4	
40374	DWL 15W 75° C90 IP54 BIANCO DL 3K	15	3000	>90	1900	1600	105	0.4	
40375	DWL 24W 75° C90 IP54 BIANCO DL 3K	24	3000	>90	3000	2600	105	0.7	
40376	DWL 32W 75° C90 IP54 BIANCO DL 3K	32	3000	>90	4000	3400	105	1	
40377	DWL 41W 75° C90 BIANCO DL 3K IP54	41	3000	>90	5000	4300	105	1.4	
OTTICA SPECULARE / SPECULAR OPTICS									
40392	DWL 15W 45° C90 IP54 BRILLA DL 4K	15	4000	>90	1900	1650	110	0.4	
40393	DWL 24W 45° C90 IP54 BRILLA DL 4K	24	4000	>90	3100	2640	110	0.7	
40394	DWL 32W 45° C90 IP54 BRILLA DL 4K	32	4000	>90	4100	3500	110	1	
40395	DWL 41W 45° C90 IP54 BRILLA DL 4K	41	4000	>90	5200	4510	110	1.4	
40444	DWL 15W 45° C90 IP54 BRILLA DL 3K	15	3000	>90	1900	1600	105	0.4	
40445	DWL 24W 45° C90 IP54 BRILLA DL 3K	24	3000	>90	3000	2600	105	0.7	
40446	DWL 32W 45° C90 IP54 BRILLA DL 3K	32	3000	>90	4000	3400	105	1	
40447	DWL 41W 45° C90 IP54 BRILLA DL 3K	41	3000	>90	5000	4300	105	1.4	

Cod.	Descrizione Description	Potenza Power W	Temp. colore Colour Temp. K	CRI	Flusso LED LED Flux lm (Tj=25°C)	Flusso Flux lm	Efficienza Efficiency lm/W	Kg	Note Notes
OTTICA SATINATA / SATIN OPTICS									
40350	DWL 15W 75° C90 IP54 SAT SDB 4K	15	4000	>90	1900	1650	110	0.4	
40351	DWL 24W 75° C90 IP54 SAT SDB 4K	24	4000	>90	3100	2640	110	0.7	
40352	DWL 32W 75° C90 IP54 SAT SDB 4K	32	4000	>90	4100	3500	110	1	
40353	DWL 41W 75° C90 IP54 SAT SDB 4K	41	4000	>90	5200	4510	110	1.4	
40380	DWL 15W 75° C90 IP54 SAT SDB 3K	15	3000	>90	1900	1600	105	0.4	
40381	DWL 24W 75° C90 IP54 SAT SDB 3K	24	3000	>90	3000	2600	105	0.7	
40382	DWL 32W 75° C90 IP54 SAT SDB 3K	32	3000	>90	4000	3400	105	1	
40383	DWL 41W 75° C90 IP54 SAT SDB 3K	41	3000	>90	5000	4300	105	1.4	
OTTICA BIANCA / WHITE OPTICS									
40354	DWL 15W 75° C90 IP54 BIANCO SDB 4K	15	4000	>90	1900	1650	110	0.4	
40355	DWL 24W 75° C90 IP54 BIANCO SDB 4K	24	4000	>90	3100	2640	110	0.7	
40356	DWL 32W 75° C90 IP54 BIANCO SDB 4K	32	4000	>90	4100	3500	110	1	
40357	DWL 41W 75° C90 IP54 BIANCO SDB 4K	41	4000	>90	5200	4510	110	1.4	
40384	DWL 15W 75° C90 IP54 BIANCO SDB 3K	15	3000	>90	1900	1600	105	0.4	
40385	DWL 24W 75° C90 IP54 BIANCO SDB 3K	24	3000	>90	3000	2600	105	0.7	
40386	DWL 32W 75° C90 IP54 BIANCO SDB 3K	32	3000	>90	4000	3400	105	1	
40387	DWL 41W 75° C90 IP54 BIANCO SDB 3K	41	3000	>90	5000	4300	105	1.4	
OTTICA SPECULARE / SPECULAR OPTICS									
40396	DWL 15W 45° C90 IP54 BRILLA SDB 4K	15	4000	>90	1900	1650	110	0.4	
40397	DWL 24W 45° C90 IP54 BRILLA SDB 4K	24	4000	>90	3100	2640	110	0.7	
40398	DWL 32W 45° C90 IP54 BRILLA SDB 4K	32	4000	>90	4100	3500	110	1	
40399	DWL 41W 45° C90 IP54 BRILLA SDB 4K	41	4000	>90	5200	4510	110	1.4	
40448	DWL 15W 45° C90 IP54 BRILLA SDB 3K	15	3000	>90	1900	1600	105	0.4	
40449	DWL 24W 45° C90 IP54 BRILLA SDB 3K	24	3000	>90	3000	2600	105	0.7	
40450	DWL 32W 45° C90 IP54 BRILLA SDB 3K	32	3000	>90	4000	3400	105	1	
40451	DWL 41W 45° C90 IP54 BRILLA SDB 3K	41	3000	>90	5000	4300	105	1.4	

RD FLUSSO-POTENZA REGOLABILI / ADJUSTABLE FLUX-POWER



STEP 1

STEP 2



STEP 3

STEP 4

Flusso/Potenza Flux/Power	15W			24W			32W			41W		
	lm	W	lm/W	lm	W	lm/W	lm	W	lm/W	lm	W	lm/W
STEP 1	1650	15	110	2640	24	110	3250	32	110	4510	41	110
STEP 2	1414	13	110	2420	22	110	3300	30	110	4295	39	110
STEP 3	1179	11	110	2200	20	110	3080	28	110	4080	37	110
STEP 4	707	6	110	1980	18	110	2860	26	110	3866	35	110

Driver RD dotato di switch con 3 step di modulazione della corrente in modo da assicurare la massima efficienza luminosa, e quindi il massimo risparmio energetico, utilizzando solo il flusso luminoso determinato in fase di progettazione



RD driver equipped with a switch with 3 steps of current modulation in order to ensure maximum luminous efficiency, and therefore maximum energy saving, using only the luminous flux determined in the design phase.

Downlight System

ACCESSORI - da ordinare separatamente / **ACCESSORIES** - to be ordered separately

	<p>RIFLETTORE TITANIO <i>TITANIUM REFLECTOR</i></p> <p>15 W - Cod. 40460 24 W - Cod. 40461 32 W - Cod. 40462 41 W - Cod. 40463</p>		<p>FILTRO ELLITTICO <i>ELLIPTIC FILTER</i></p> <p>15W - Cod. 40468 24 W - Cod. 40469 32 W - Cod. 40470 41 W - Cod. 40471</p>
	<p>FILTRO HONEYCOMB <i>HONEYCOMB FILTER</i></p> <p>15W - Cod. 40464 24 W - Cod. 40465 32 W - Cod. 40466 41 W - Cod. 40467</p>		<p>FILTRO ASIMMETRICO <i>ASYMMETRICAL FILTER</i></p> <p>15W - Cod. 40472 24 W - Cod. 40473 32 W - Cod. 40474 41 W - Cod. 40475</p>
	<p>FILTRO DOPPIO ASIMMETRICO <i>DOUBLE ASYMMETRICAL FILTER</i></p> <p>15W - Cod. 40476 24 W - Cod. 40477 32 W - Cod. 40478 41 W - Cod. 40479</p>		<p>ADATTATORE / ADAPTER Ø195÷220mm</p> <p>24W - Cod. 40480 32W - Cod. 40481 41W - Cod. 40482</p>

EMERGENZA CON INVERTER LED - da ordinare separatamente EMERGENCY LED INVERTER - to be ordered separately

	<p>INVERTER PLUG&LIGHT SE/SA 20-60V</p> <p>1h - Cod. 19358 3h - Cod. 19359</p> <p style="text-align: right;">TR</p>		<p>MODULO / MODULE LG - LGFM - DALI Solo per Inverter CT / For CT Inverters only</p> <p>LG - Cod. 15079 LGFM - Cod. 15037 DALI - Cod. 15080</p> <p style="text-align: right;"> LG LGFM DALI </p>
	<p>INVERTER UNIVERSALE 5W 20-240V</p> <p>AT - Cod. 19398 CT - Cod. 19399</p> <p style="text-align: right;">AT CT</p>		

SD  **ACCESSORI** - da ordinare separatamente / **ACCESSORIES** - to be ordered separately



CENTRALE LOGICA
LOGICA CONTROL UNIT

SD LGFM - Cod. **21102**



MODULO RADIO
RADIO MODULE

Cod. **15054**



CONCENTRATORE WIFI BLUETOOTH
WiFi BLUETOOTH CONCENTRATOR
1 ingresso di controllo / 1 control input

Cod. **15064** 



MODULO INTERFACCIA BLUETOOTH
BLUETOOTH MODULE INTERFACE
3 ingressi di controllo / 3 control inputs

Cod. **15065** 



SENSORE PRESENZA
MOTION SENSOR

INDUSTR IP65 - Cod. **15063**
UFFICI IP40 - Cod. **15062**



CONCENTRATORE BLUETOOTH EASY BOX
BLUETOOTH EASY BOX CONCENTRATOR

WiFi - Cod. **15174**
WiFi ETHERNET - Cod. **15074** 

Sistema di trasmissione wireless integrato che permette la comunicazione fra gli apparecchi in modo da realizzare gruppi che attuano gli stessi comandi senza aggiungere ulteriori cablaggi. Utilizzando il Modulo interfaccia Bluetooth è possibile comandare i gruppi in modalità wireless. Per gestire un impianto centralizzato da APP B.connect occorre integrare il Concentratore Bluetooth. *Integrated wireless transmission system for communication between luminaires in order to create groups with the same commands without adding further wiring. Using the Bluetooth Interface Module it is possible to control the groups wireless. To manage a centralized system from the B.connect APP, the Bluetooth concentrator must be integrated.*



Downlight Compact



IP42

IK05

650°

 +40°C
-20°C

Caratteristiche

Mantenimento flusso luminoso a 25°C

>30.000h (L80B20)

Installazioni Incasso

Corpo Policarbonato

Ottica Diffondente, simmetrica

Schermo Policarbonato finitura opale

Colore Bianco

Conformità EN60598-1, EN60598-2-2,
EN 62471

Applicazioni

Residenziale, terziario, retail, uffici,
scuole

Characteristics

Luminous flux retention at 25°C

>30.000h (L80B20)

Mounting Recessed

Housing Polycarbonate

Ottica Diffusing, symmetrical

Screen opal Polycarbonate

Colour White

Compliance EN60598-1, EN60598-2-2,
EN 62471

Applications

Services sector, residential, retail,
offices, schools

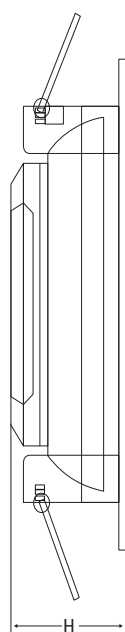
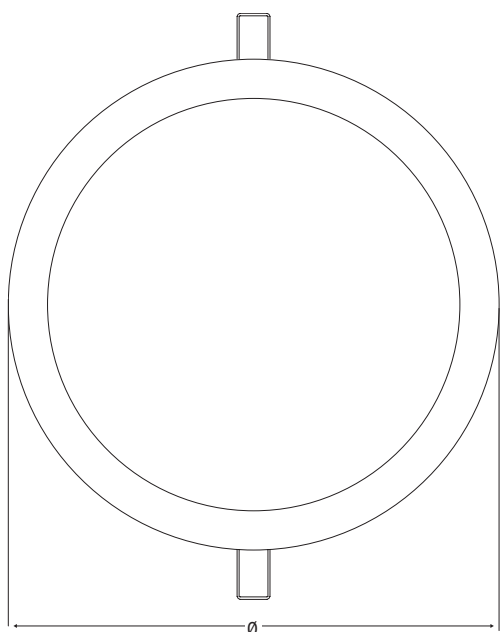

W	Foro incasso Recess hole mm	Dimensioni Dimensions mm	
		Ø	H
10	Ø 90	120	60
15	Ø 120	150	60
25	Ø 170	200	60
30	Ø 200	230	60

DOWNLIGHT COMPACT

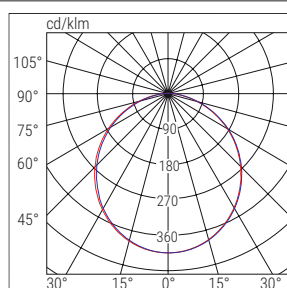

■ C0-C180 ■ C90-C270

	Cod.	Descrizione Description	Potenza Power W	Temp. colore Colour Temp. K	CRI	Flusso LED LED Flux lm (Tj=25°C)	Flusso Flux lm	Efficienza Efficiency lm/W	Kg
LED	71052	DWL LED 10W 3K	10	3000	≥80	1350	900	90	0.14
	71054	DWL LED 15W 3K	15	3000	≥80	1800	1350	90	0.20
	71056	DWL LED 25W 3K	25	3000	≥80	3150	2250	90	0.33
	71058	DWL LED 30W 3K	30	3000	≥80	3600	2700	90	0.48
	71053	DWL LED 10W 4K	10	4000	≥80	1350	900	90	0.14
	71055	DWL LED 15W 4K	15	4000	≥80	1800	1350	90	0.20
	71057	DWL LED 25W 4K	25	4000	≥80	3150	2250	90	0.33
	71059	DWL LED 30W 4K	30	4000	≥80	3600	2700	90	0.48

ON / OFF



057 downlight

Downlight Ultra Compact



IP42

IK05

650°

 +40°C
-20°C

Caratteristiche

Mantenimento flusso luminoso a 25°C

>35.000h (L80B20)

Installazioni Incasso

Corpo Policarbonato

Ottica Diffondente, simmetrica

Schermo Policarbonato finitura opale

Colore Bianco

Conformità EN60598-1, EN60598-2-2,
EN 62471

Applicazioni

Residenziale, terziario, retail, uffici

Characteristics

Luminous flux retention at 25°C

>30.000h (L80B20)

Mounting Recessed

Housing Polycarbonate

Ottica Diffusing, symmetrical

Screen opal Polycarbonate

Colour White

Compliance EN60598-1, EN60598-2-2,
EN 62471

Applications

Services sector, residential, retail, offices

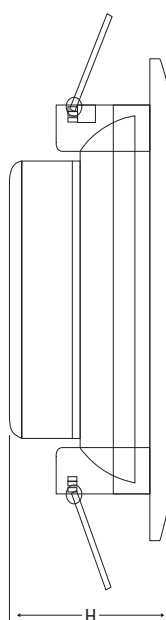
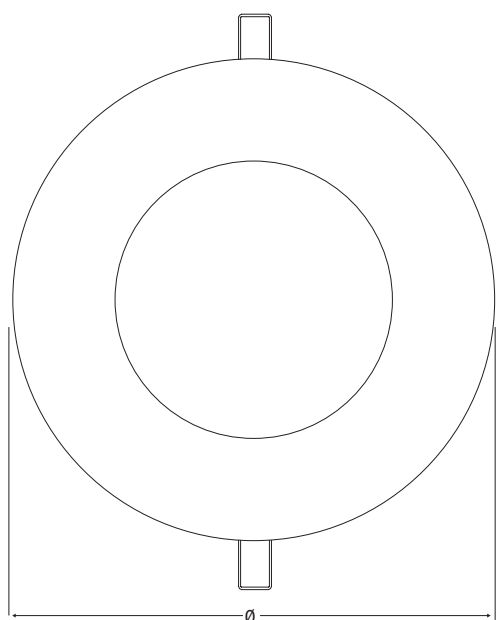

Foro incasso Recess hole mm	Dimensioni Dimensions mm	
	Ø	H
Ø 70	85	30

DOWNLIGHT ULTRA COMPACT

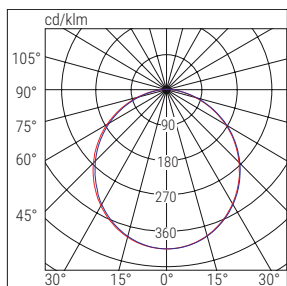

■ C0-C180

■ C90-C270

	Cod.	Descrizione Description	Potenza Power W	Temp. colore Colour Temp. K	CRI	Flusso LED LED Flux lm (Tj=25°C)	Flusso Flux lm	Efficienza Efficiency lm/W	Kg	
ED	71050	DWL LED 8W 3K	8	3000	>80	1080	720	90	0.07	ON / OFF
	71051	DWL LED 8W 4K	8	4000	>80	1080	720	90	0.07	



059 downlight

Downlight Ultrathin



WEB
CATALOGUE



IP20

IK05

650°



+40°C
-20°C

Caratteristiche

Mantenimento flusso luminoso a 25°C

>30.000h (L80B20)

Installazioni Incasso

Corpo Policarbonato

Ottica Diffondente, simmetrica

Schermo PC finitura opale

Colore Bianco

Conformità EN60598-1, EN60598-2-2,
EN 62471

Applicazioni

Residenziale, terziario, retail, uffici

Non idoneo per uso intensivo.

Characteristics

Luminous flux retention at 25°C

>30.000h (L80B20)

Mounting Recessed

Housing Polycarbonate

Ottica Diffusing, symmetrical

Screen opal Polycarbonate

Colour White

Compliance EN60598-1, EN60598-2-2,
EN 62471

Applications

Services sector, residential, retail, offices.

Not suitable for intensive use

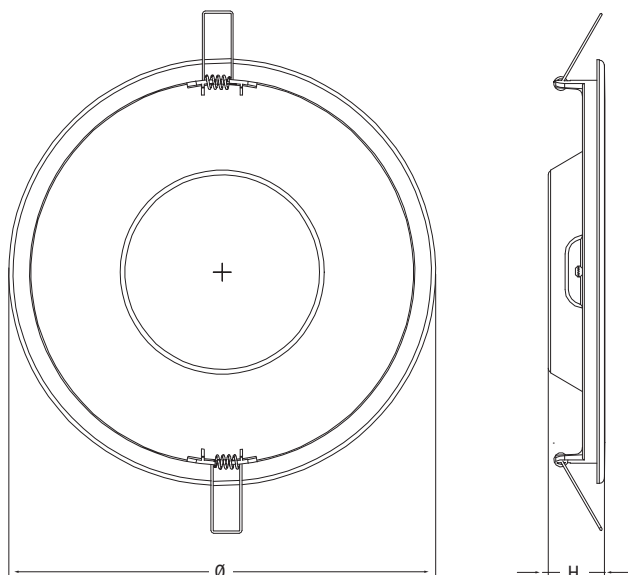

W	Foro incasso Recessed hole mm	Dimensioni Dimensions mm	
		Ø	H
12	Ø 155	170	25
18	Ø 210	229	25
24	Ø 280	298	25

DWL ULTRATHIN

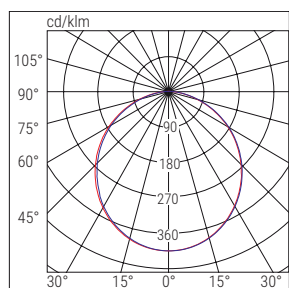

■ C0-C180

■ C90-C270

	Cod.	Descrizione Description	Potenza Power W	Temp. colore Colour Temp. K	CRI	Flusso LED LED Flux lm (Tj=25°C)	Flusso Flux lm	Efficienza Efficiency lm/W	Kg	
ED	75350	ULTRATHIN DWL LED 12W 4K	12	4000	>80	1500	1000	80	0.2	ON / OFF
	75351	ULTRATHIN DWL LED 18W 4K	18	4000	>80	2500	1500	80	0.3	
	75352	ULTRATHIN DWL LED 24W 4K	24	4000	>80	3200	2000	80	0.5	



061 downlight

Downlight Ultrathin SQ



Caratteristiche

Mantenimento flusso luminoso a 25°C

>30.000h (L80B20)

Installazioni Incasso

Corpo Policarbonato

Ottica Diffondente, simmetrica

Schermo PC finitura opale

Colore Bianco

Conformità EN60598-1, EN60598-2-2,
EN 62471

Applicazioni

Residenziale, terziario, retail, uffici.

Non idoneo per uso intensivo.

Characteristics

Luminous flux retention at 25°C

>30,000h (L80B20)

Mounting Recessed

Housing Polycarbonate

Ottica Diffusing, symmetrical

Screen opal Polycarbonate

Colour White

Compliance EN60598-1, EN60598-2-2,
EN 62471

Applications

Services sector, residential, retail, offices.

Not suitable for intensive use

IP20

IK05

650°

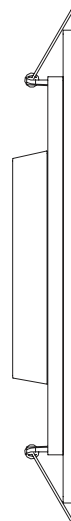
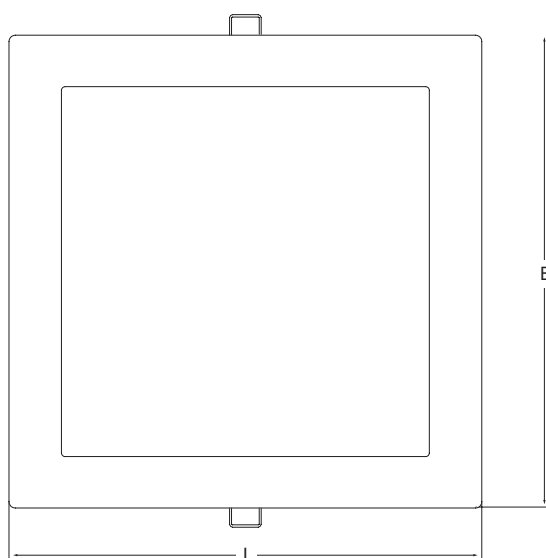
+40°C
-20°C

W	Foro incasso Recessed hole mm	Dimensioni Dimensions mm		
		L	B	H
12	155	170	170	25
18	185	202	202	25
24	250	270	270	25

DWL ULTRATHIN SQ

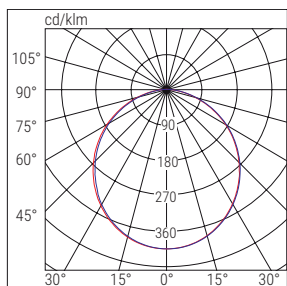

■ C0-C180 ■ C90-C270

	Cod.	Descrizione Description	Potenza Power W	Temp. colore Colour Temp. K	CRI	Flusso LED LED Flux lm (Tj=25°C)	Flusso Flux lm	Efficienza Efficiency lm/W	Kg	
ED	75353	ULTRATHIN DWL SQ LED 12W 4K	12	4000	>80	1500	1000	80	0.2	ON / OFF
	75354	ULTRATHIN DWL SQ LED 18W 4K	18	4000	>80	2500	1500	80	0.3	
	75355	ULTRATHIN DWL SQ LED 24W 4K	24	4000	>80	3200	2000	80	0.5	



063 downlight

X-Six Multipower

illuminazione / lighting



WEB
CATALOGUE



IP20

IK05

650°



+40°C
-20°C

CCT

MULTIPOWER

Caratteristiche

Mantenimento flusso luminoso a 25°C

>30.000h (L80B20)

Installazioni Incasso, plafone

Corpo Polycarbonato

Ottica Diffondente, simmetrica

Schermo Polycarbonato finitura opale

Colore Bianco

Conformità EN60598-1, EN60598-2-2,

EN 62471

Applicazioni

Residenziale, terziario, retail, uffici

Non idoneo per uso intensivo

Characteristics

Luminous flux retention at 25°C

>30.000h (L80B20)

Mounting Recessed, ceiling

Housing Polycarbonate

Ottica Diffusing, symmetrical

Screen opal Polycarbonate

Colour White

Compliance EN60598-1, EN60598-2-2,

EN 62471

Applications

Services sector, residential, retail, offices

Not suitable for intensive use

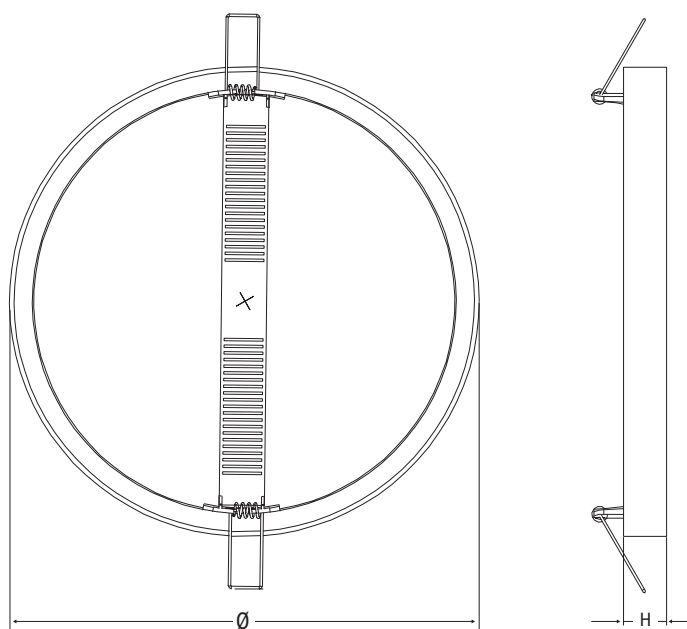

Versione Version	Foro incasso Recess hole mm	Dimensioni Dimensions mm	
		Ø	H
S	Ø55÷200	225	20
M	Ø55÷280	300	20

064

X-SIX MULTIPOWER

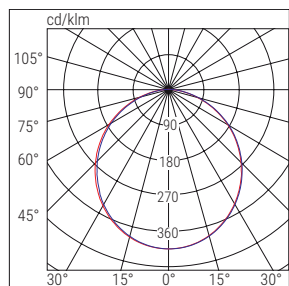

■ C0-C180 ■ C90-C270

SISTEMA MULTIPOWER

Il sistema Multipower è in grado di selezionare la potenza in base alla reale esigenza di illuminazione, questo per evitare un eccessivo illuminamento in un'ottica di risparmio energetico. Nel retro è presente un apposito switch per la regolazione della potenza che si affianca a quello disponibile in tutte le versioni per la regolazione della temperatura colore (CCT).

MULTIPOWER SYSTEM

The Multipower system is able to select the power based on the real lighting need, this is to avoid excessive lighting for saving energy. On the back there is a Multipower switch for power regulation and the CCT switch, available in all versions, for regulating the color temperature.



CCT SWITCH

MULTIPOWER SWITCH

STAFFA REGOLABILE / ADJUSTABLE BRACKET

STAFFA POSTERIORE A DIAMETRO DI FISSAGGIO REGOLABILE

Sistema di installazione che permette di utilizzare fori già esistenti o di ottimizzare gli utensili di foratura dell'installatore. Staffa posteriore removibile dotata di posizioni preimpostate per adattarsi a diametri differenti:

12W fori compresi fra 55 e 200mm

18W fori compresi fra 55 e 280mm



REAR BRACKET WITH ADJUSTABLE FIXING DIAMETER

Installation system to use existing holes or optimize the installer's drilling tools. Removable rear bracket equipped with preset positions to adapt to different hole diameters:

12W holes between to 55 and 200mm

18W holes between to 55 and 280mm

Versione Version	Cod.	Descrizione Description	Potenza Power W	Temp. colore Colour Temp. K	CRI	Flusso LED LED Flux lm (Tj=25°C)	Flusso Flux lm	Efficienza Efficiency lm/W	Kg	
S	71064	X-SIX LED CCT REG MULTIPOWER S	9-12-18	CCT 3000-4000-6000	>80	1026/1500/2052	810/1080/1620	90	0.5	CCT
M	71065	X-SIX LED CCT REG MULTIPOWER M	12-18-24	CCT 3000-4000-6000	>80	1500/2052/3000	1080/1620/2160	90	0.7	

X-Six Regolabile

illuminazione / lighting



WEB
CATALOGUE



IP20

IK05

650°



+40°C
-20°C

CCT

Caratteristiche

Mantenimento flusso luminoso a 25°C
>30.000h (L80B20)

Installazioni Incasso, plafone

Corpo Policarbonato

Ottica Diffondente, simmetrica

Schermo Policarbonato finitura opale

Colore Bianco

Conformità EN60598-1, EN60598-2-2,
EN 62471

Applicazioni

Terziario, residenziale, retail, uffici,
scuole. Non idoneo per uso intensivo.

Characteristics

Luminous flux retention at 25°C
>30.000h (L80B20)

Mounting Recessed, ceiling

Housing Polycarbonate

Ottica Diffusing, symmetrical

Screen opal Polycarbonate

Colour White

Compliance EN60598-1, EN60598-2-2,
EN 62471

Applications

Services sector, residential, retail, offices.
Not suitable for intensive use

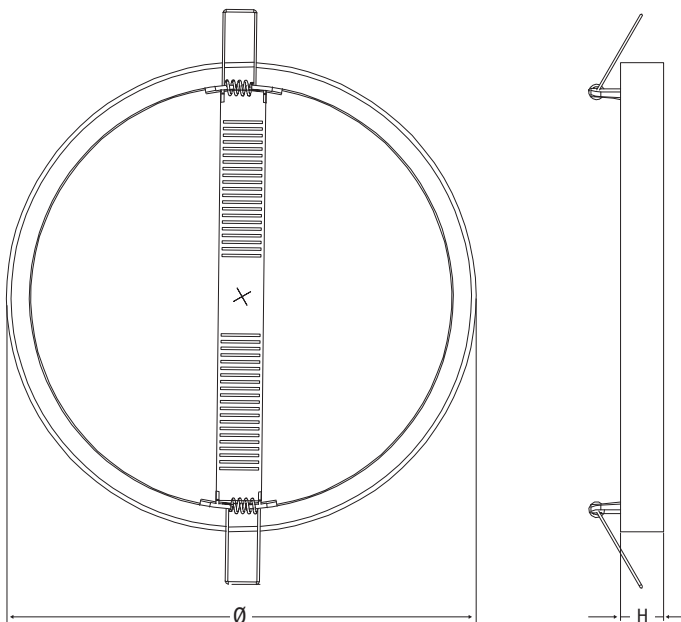

W	Foro incasso Recess hole mm	Dimensioni Dimensions mm	
		Ø	H
18	Ø 65÷210	225	20
24	Ø 65÷310	330	20

066

X-SIX REGOLABILE 18W

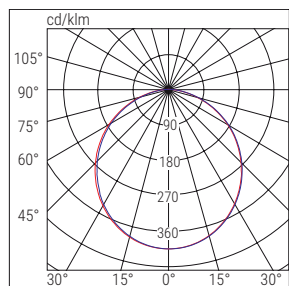

■ C0-C180 ■ C90-C270

X-SIX REGOLABILE 24W

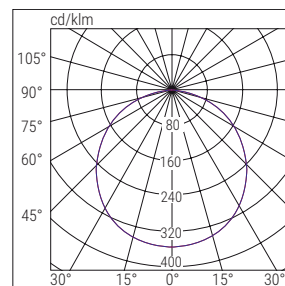

■ C0-C180 ■ C90-C270



STAFFA POSTERIORE A DIAMETRO DI FISSAGGIO REGOLABILE

Sistema di installazione che permette di utilizzare fori già esistenti o di ottimizzare gli utensili di foratura dell'installatore. Staffa posteriore removibile dotata di posizioni preimpostate per adattarsi a diametri differenti:

18W fori compresi fra 65 e 210mm

24W fori compresi fra 65 e 310mm

REAR BRACKET WITH ADJUSTABLE FIXING DIAMETER

Installation system to use existing holes or optimize the installer's drilling tools. Removable rear bracket equipped with preset positions to adapt to different hole diameters:

18W holes between to 65 and 210mm

24W holes between to 65 and 310mm

Cod.	Descrizione Description	Potenza Power W	Temp. colore Colour Temp. K	CRI	Flusso LED LED Flux lm (Tj=25°C)	Flusso Flux lm	Efficienza Efficiency lm/W	Kg
71062	X-SIX DWL LED CCT REG 18W	18	CCT 3000-4000-6000	>80	2000	1440	80	0.4
71063	X-SIX DWL LED CCT REG 24W	24	CCT 3000-4000-6000	>80	2500	1920	80	0.8

ED

CCT

X-Six CCT

illuminazione / lighting



IP20

IK05

650°



+40°C
-20°C

CCT

Caratteristiche

Mantenimento flusso luminoso a 25°C

>30.000h (L80B20)

Installazioni Incasso, plafone

Corpo Policarbonato

Ottica Diffondente, simmetrica

Schermo Policarbonato finitura opale

Colore Bianco

Conformità EN60598-1, EN60598-2-2,
EN 62471

Applicazioni

Residenziale, terziario, retail, uffici

Non idoneo per uso intensivo.

Characteristics

Luminous flux retention at 25°C

>30.000h (L80B20)

Mounting Recessed, ceiling

Housing Polycarbonate

Ottica Diffusing, symmetrical

Screen opal Polycarbonate

Colour White

Compliance EN60598-1, EN60598-2-2,
EN 62471

Applications

Services sector, residential, retail, offices.

Not suitable for intensive use

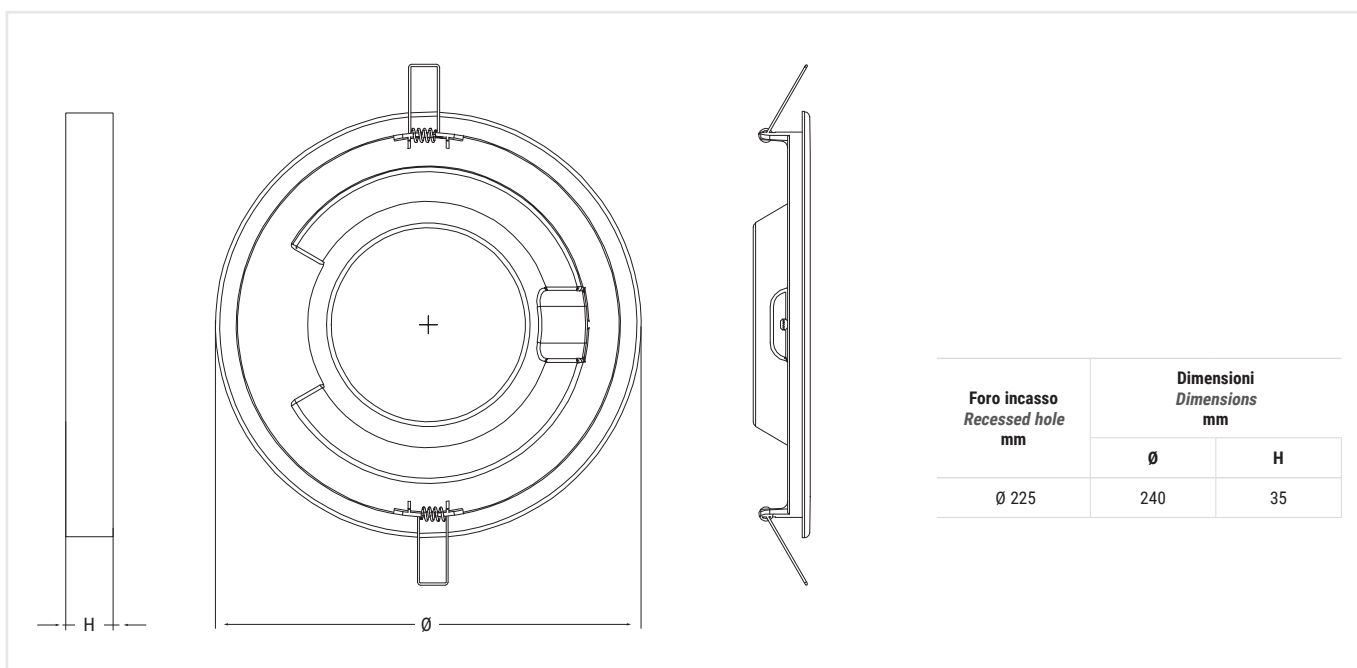

Foro incasso Recessed hole mm	Dimensioni Dimensions mm	
	Ø	H
Ø 225	240	35

068

X-SIX

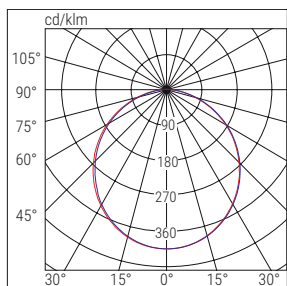

■ C0-C180

■ C90-C270



STAFFA RAPIDA CON DISTANZIALE PER INSTALLAZIONE A PLAFONE

Questo apparecchio è dotato di un sistema che ne permette l'installazione sia ad incasso che a plafone. Nel caso dell'installazione ad incasso sono incluse due molle che si innestano a scatto nel retro del corpo. Nel caso dell'installazione a plafone si utilizza un anello distanziale che si inserisce nell'apparecchio, a sua volta dotato di una staffa da fissare a soffitto su cui inserire l'apparecchio con innesto a baionetta.

QUICK BRACKET WITH SPACER FOR CEILING INSTALLATION

This appliance is equipped with a system which permits both recessed and ceiling installation. In the case of recessed installation, two springs are included into the back of the body. In the case of ceiling mounted installation, a spacer ring is inserted into the luminaire equipped with a bracket to be fixed to the ceiling.

Cod.	Descrizione Description	Potenza Power W	Temp. colore Colour Temp. K	CRI	Flusso LED LED Flux lm (Tj=25°C)	Flusso Flux lm	Efficienza Efficiency lm/W	Kg
71060	X-SIX LED CCT20W	20	CCT 3000-4000-6500	>80	2100	1600	80	0.5

ACCESSORI - in dotazione / ACCESSORIES - included

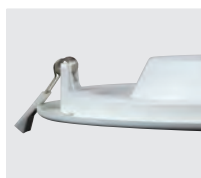

MOLLE PER INSTALLAZIONE A INCASSO SPRINGS FOR RECESSED INSTALLATION

2 pezzi / 2 pc

X-Six SQ Multipower

illuminazione / lighting



WEB
CATALOGUE



IP20

IK05

650°



+40°C
-20°C

CCT

MULTIPOWER

Caratteristiche

Mantenimento flusso luminoso a 25°C
>30.000h (L80B20)

Installazioni Incasso, plafone

Corpo Policarbonato

Ottica Diffondente, simmetrica

Schermo Policarbonato finitura opale

Colore Bianco

Conformità EN60598-1, EN60598-2-2,
EN 62471

Applicazioni

Residenziale, terziario, retail, uffici

Non idoneo per uso intensivo.

Characteristics

Luminous flux retention at 25°C
>30.000h (L80B20)

Mounting Recessed, ceiling

Housing Polycarbonate

Ottica Diffusing, symmetrical

Screen opal Polycarbonate

Colour White

Compliance EN60598-1, EN60598-2-2,
EN 62471

Applications

Services sector, residential, retail, offices.

Not suitable for intensive use

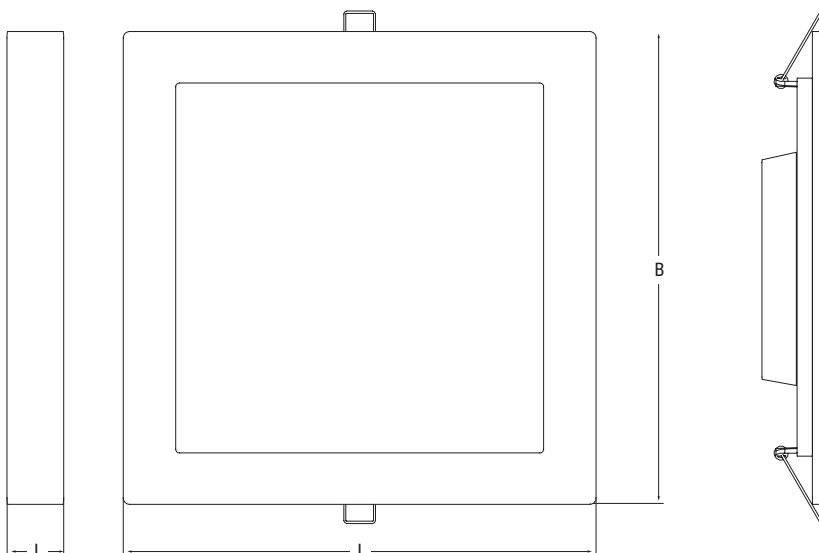

Versione Version	Foro incasso Recessed hole mm	Dimensioni Dimensions mm		
		L	B	H
S	Ø55÷200	225	225	20
M	Ø55÷280	300	300	20

070

X-SIX SQ MULTIPOWER

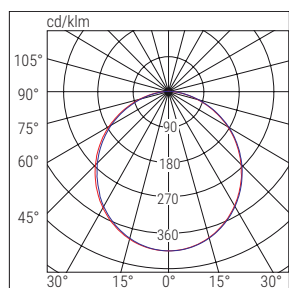

■ C0-C180 ■ C90-C270

SISTEMA MULTIPOWER

Il sistema Multipower è in grado di selezionare la potenza in base alla reale esigenza di illuminazione, questo per evitare un eccessivo illuminamento in un'ottica di risparmio energetico. Nel retro è presente un apposito switch per la regolazione della potenza che si affianca a quello disponibile in tutte le versioni per la regolazione della temperatura colore (CCT).

MULTIPOWER SYSTEM

The Multipower system is able to select the power based on the real lighting need, this is to avoid excessive lighting for saving energy. On the back there is a Multipower switch for power regulation and the CCT switch, available in all versions, for regulating the color temperature.

CCT SWITCH

MULTIPOWER SWITCH

STAFFA REGOLABILE / ADJUSTABLE BRACKET



STAFFA POSTERIORE A DIAMETRO DI FISSAGGIO REGOLABILE

Sistema di installazione che permette di utilizzare fori già esistenti o di ottimizzare gli utensili di foratura dell'installatore. Staffa posteriore removibile dotata di posizioni preimpostate per adattarsi a a diametri differenti: 12W fori compresi fra 55 e 200mm
18W fori compresi fra 55 e 280mm



REAR BRACKET WITH ADJUSTABLE FIXING DIAMETER

Installation system to use existing holes or optimize the installer's drilling tools. Removable rear bracket equipped with preset positions to adapt to different hole diameters:

12W holes between to 55 and 200mm

18W holes between to 55 and 280mm

Versione Version	Cod.	Descrizione Description	Potenza Power W	Temp. colore Colour Temp. K	CRI	Flusso LED LED Flux lm (Tj=25°C)	Flusso Flux lm	Efficienza Efficiency lm/W	Kg	CCT
S	71066	X-SIX SQ LED CCT MULTIPOWER S	9-12-18	CCT 3000-4000-6000	>80	1026/1500/2052	810/1080/1620	90	0.5	
M	71067	X-SIX SQ LED CCT MULTIPOWER M	12-18-24	CCT 3000-4000-6000	>80	1500/2052/3000	1080/1620/2160	90	0.7	

X-Six SQ CCT

illuminazione / lighting

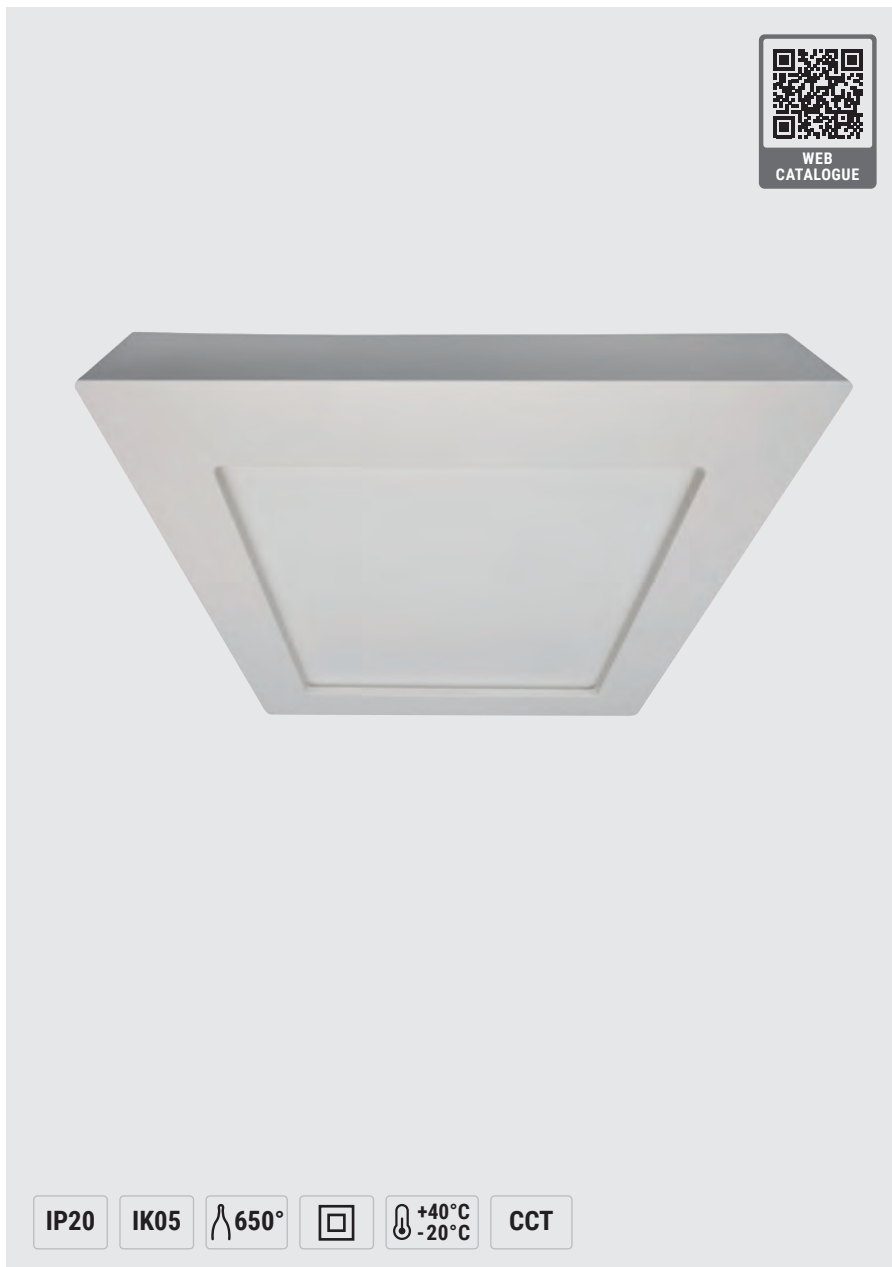

Caratteristiche

Mantenimento flusso luminoso a 25°C

>30.000h (L80B20)

Installazioni Incasso, plafone

Corpo Policarbonato

Ottica Diffondente, simmetrica

Schermo Policarbonato finitura opale

Colore bianco

Conformità EN60598-1, EN60598-2-2,
EN 62471

Applicazioni

Residenziale, terziario, retail, uffici

Non idoneo per uso intensivo.

Characteristics

Luminous flux retention at 25°C

>30.000h (L80B20)

Mounting Recessed, ceiling

Housing Polycarbonate

Ottica Diffusing, symmetrical

Screen opal Polycarbonate

Colour White

Compliance EN60598-1, EN60598-2-2,
EN 62471

Applications

Services sector, residential, retail, offices.

Not suitable for intensive use

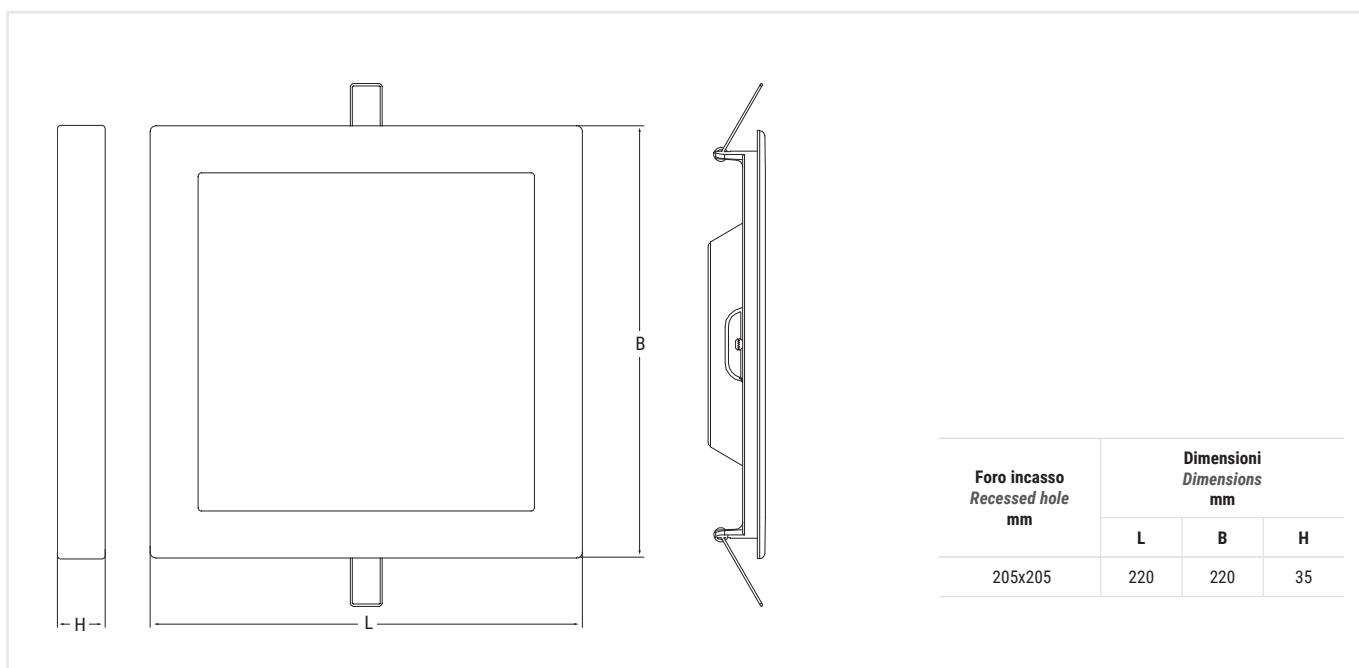

Foro incasso Recessed hole mm	Dimensioni Dimensions mm		
	L	B	H
205x205	220	220	35

072

X-SIX SQ

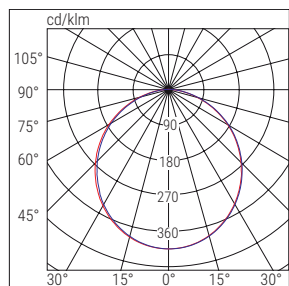

■ C0-C180 ■ C90-C270

STAFFA PER INSTALLAZIONE A PLAFONE CON FISSAGGIO A BAIONETTA

Questo apparecchio è dotato di un sistema che ne permette l'installazione sia ad incasso che a plafone. Nel caso dell'installazione ad incasso sono incluse due molle che si innestano a scatto nel retro del corpo. Nel caso dell'installazione a plafone si utilizza un distanziale che si inserisce nell'apparecchio, a sua volta dotato di una staffa da fissare a soffitto su cui inserire l'apparecchio con innesto a baionetta.



QUICK BRACKET WITH SPACER FOR CEILING INSTALLATION

This appliance is equipped with a system which permits both recessed and ceiling installation. In the case of recessed installation, two springs are included into the back of the body. In the case of ceiling mounted installation, a spacer ring is inserted into the luminaire equipped with a bracket to be fixed to the ceiling.

Cod.	Descrizione Description	Potenza Power W	Temp. colore Colour Temp. K	CRI	Flusso LED LED Flux lm (Tj=25°C)	Flusso Flux lm	Efficienza Efficiency lm/W	Kg
71061	X-SIX SQ LED CCT 20W	20	CCT 3000-4000-6500	>80	2100	1600	80	0.5

ACCESSORI - in dotazione / ACCESSORIES - included



MOLLE PER INSTALLAZIONE A INCASSO SPRINGS FOR RECESSED INSTALLATION

2 pezzi / 2 pc

BS Uno Modula

illuminazione / lighting



Caratteristiche

Mantenimento flusso luminoso a 25°C
60.000 (L80B20)

Installazioni Parete, soffitto, barra elettrificata, sospensione

Corpo Policarbonato, grigio RAL 7035

Ottica Acciaio verniciato alle polveri di colore bianco riflettente

Schermo Policarbonato opale, con diffusore ottico perimetrale antiabbagliamento

Conformità EN 60598-1, EN 60598-2-1, EN 60598-2-22, DIN 18032-3:1997-04, EN 62471 (Rischio fotobiologico esente), 2014/53/UE, EN60598-2-22

Applicazioni

Industriale, terziario, palestre, aree esterne, aree soggette ad HACCP

Characteristics

Luminous flux retention at 25°C
60.000 (L80B20)

Mounting Ceiling, suspended, electrified track

Housing Polycarbonate, RAL 7035

Optics Reflective white powder-coated steel

Screen opal Polycarbonate, anti-glare screen with perimetral microprismatization

Compliance EN 60598-1, EN 60598-2-1, EN 60598-2-22, DIN 18032-3:1997-04, EN 62471 (Photobiological risk-free), 2014/53/EU

Applications

Industry, services sector, car parks, gym, outdoor areas, HACCP areas

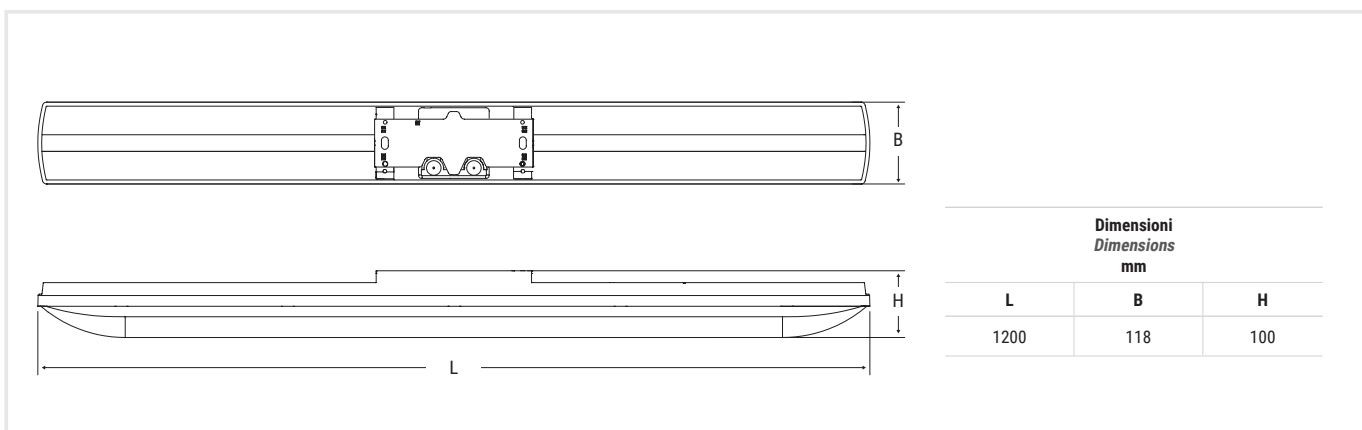

BS UNO MODULA



Schermo antiabbagliamento con microprismatura perimetrale / Anti-glare screen with perimetral microprismatization

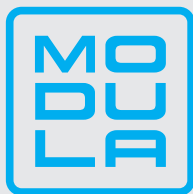
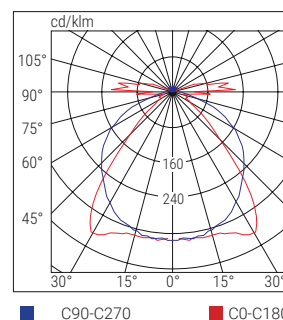

STAFFA DI DERIVAZIONE EASY BOX INTEGRATA INTEGRATED EASY BOX JUNCTION BRACKET

Staffa con sistema rapido di fissaggio meccanico con contatto elettrico a scatto, morsettiera estraibile e vari fori in prerottura per il cablaggio, anche passante. La versione SD integra, oltre ai PIN di collegamento elettrico con la morsettiera, anche uno slot per inserire i vari Moduli per l'illuminazione di emergenza o ulteriori accessori di comunicazione sia radio che Bluetooth.

Rapid mechanical fixing Bracket with snap-in electrical contact, extractable terminal block and various pre-drilled holes for wiring, including through-wiring. The SD version integrates, in addition to the electrical connection PINs with the terminal block, also a slot to insert the various modules for emergency lighting or further communication accessories, both radio and Bluetooth.



	Cod.	Descrizione Description	Potenza Power W	Temp. colore Colour Temp. K	CRI	Flusso LED LED Flux lm (Tj=25°C)	Flusso Flux lm	Efficienza Efficiency lm/W	Kg	Note
RD	41304	BS UNO MODULA RD 51W 4K	51	4000	>80	9200	8000	157	1.9	REGOLABILE
	41305	BS UNO MODULA RD 60W 4K	60	4000	>80	11500	10000	167	1.9	
	41306	BS UNO MODULA RD 72W 4K	72	4000	>80	13800	12000	167	1.9	
DALI	41314	BS UNO MODULA DALI 51W 4K	51	4000	>80	9200	8000	157	1.9	DALI
	41315	BS UNO MODULA DALI 60W 4K	60	4000	>80	11500	10000	167	1.9	
	41316	BS UNO MODULA DALI 72W 4K	72	4000	>80	13800	12000	167	1.9	
SD	41324	BS UNO MODULA SDB 51W 4K	51	4000	>80	9200	8000	157	1.9	AUTODIMMER
	41325	BS UNO MODULA SDB 60W 4K	60	4000	>80	11500	10000	167	1.9	
	41326	BS UNO MODULA SDB 72W 4K	72	4000	>80	13800	12000	167	1.9	

RD FLUSSO-POTENZA REGOLABILI / ADJUSTABLE FLUX-POWER

	Flusso/Potenza Flux/Power	Cod. 41304			Cod. 41305			Cod. 41306		
		lm	W	lm/W	lm	W	lm/W	lm	W	lm/W
STEP 1		8000	51	157	10000	60	167	12000	72	167
STEP 2		7300	44	166	8500	50	170	11400	68	168
STEP 3		6000	34	176	7400	43	172	10800	64	169
STEP 4		5150	29	178	5900	34	174	10100	35	171

Driver RD dotato di switch con 4 step di modulazione della corrente in modo da assicurare la massima efficienza luminosa, e quindi il massimo risparmio energetico, utilizzando solo il flusso luminoso determinato in fase di progettazione / RD driver equipped with a switch with 4 steps of current modulation in order to ensure maximum luminous efficiency, and therefore maximum energy saving, using only the luminous flux determined in the design phase.

SEGUE / NEXT >

BS Uno Modula

SISTEMA RAPIDO DI FISSAGGIO A PLAFONE / QUICK CEILING FIXING SYSTEM



Staffa di supporto centrale dotata di fori di fissaggio a plafone e due staffe elastiche in INOX fissabili a scatto direttamente sulla staffa o a soffitto, lungo il profilo della plafoniera o in posizioni preimpostate a passo 900mm

Central support main bracket equipped with fixing holes and two elastic stainless steel brackets to snap directly onto the main bracket or to the ceiling, along the profile of the ceiling light or in pre-set positions with a 900mm pitch

ACCESSORI - in dotazione / ACCESSORIES - included



STAFFA DI DERIVAZIONE EASY BOX
MODULA JUNCTION BRACKET



SENSORE AUTODIMMER
SMART LIGHT SENSOR

ACCESSORI - da ordinare separatamente / ACCESSORIES - to be ordered separately

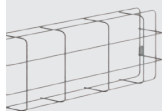

GRIGLIA DI PROTEZIONE
PROTECTIVE GRILLE

Cod. **8063** 1700 x 291 x 135 mm

Nota di installazione / Installation note

Per il montaggio delle griglie con apparecchio installato su blindosbarra occorre utilizzare : Staffa **8063/1**

*When installing grilles with the luminaire installed on a bus bar, use: Bracket **8063/1***

EMERGENZA CON INVERTER LED - da ordinare separatamente EMERGENCY LED INVERTER - to be ordered separately



MODULO/MODULE TR - LG230 - LG24 - EPS

TR - Cod. **15068** (6W 1h - 6/2W 1/3h)
LG24 - Cod. **15059** - versione SD / SD Version
LG230 - Cod. **15060** - versione SD / SD Version
LG EPS - Cod. **15075** - versione SD / SD Version



BOOSTER BATTERY

Batteria LiFe 6.4V 1,5Ah - Raddoppia la Potenza (10W) e il Flusso luminoso (1600lm) in emergenza
LiFe 6.4V 1,5Ah Battery - Double the Power (10W) and the Emergency Flux (1600lm)

Cod. **RA13**



MODULO LGFM
LGFM MODULE

Cod. **15037**

La versione TR si ottiene sostituendo la Staffa di derivazione Modula con la versione TR. Le **versioni AT e CT vengono invece fornite con inverter già integrato**: il codice relativo si ottiene aggiungendo la desinenza AT o CT, (41324 diventa, in versione autotest 41324AT), **la versione AT integra la funzione RM**, **la versione CT, può alloggiare il modulo LGFM LG e DALI**.

TR version is obtained by replacing the Modula junction bracket with the TR version. The AT and CT versions are supplied with an already integrated inverter: the order code is obtained by adding the suffix AT or CT, (41324 becomes 41324AT in the self-test version), the AT version integrates the RM function, the CT can house the LGFM, LG, DALI module.



CENTRALE LOGICA
LOGICA CONTROL UNIT

SD LGFM - Cod. **21102**



MODULO SD RADIO
SD RADIO MODULES

Cod. **15067**



CONCENTRATORE WIFI BLUETOOTH
WiFi BLUETOOTH CONCENTRATOR
1 ingresso di controllo / 1 control input

Cod. **15064** 



MODULO INTERFACCIA BLUETOOTH
BLUETOOTH MODULE INTERFACE
3 ingressi di controllo / 3 control inputs

Cod. **15065** 



CONCENTRATORE BLUETOOTH EASY BOX
BLUETOOTH EASY BOX CONCENTRATOR

WiFi - Cod. **15174**
WiFi ETHERNET - Cod. **15074** 



SENSORE PRESENZA
MOTION SENSOR

INDUSTR IP65 - Cod. **15063**
UFFICI IP40 - Cod. **15062**

Sistema di trasmissione wireless integrato che permette la comunicazione fra gli apparecchi in modo da realizzare gruppi che attuano gli stessi comandi senza aggiungere ulteriori cablaggi. Utilizzando il Modulo interfaccia Bluetooth è possibile comandare i gruppi in modalità wireless. Per gestire un impianto centralizzato da APP B.connect occorre integrare il Concentratore Bluetooth. *Integrated wireless transmission system for communication between luminaires in order to create groups with the same commands without adding further wiring. Using the Bluetooth Interface Module it is possible to control the groups wireless. To manage a centralized system from the B.connect APP, the Bluetooth concentrator must be integrated.*

IL SISTEMA MODULA SEMPLIFICA TUTTI I PRINCIPALI TIPI DI INSTALLAZIONE
MODULA SYSTEM MAKE EASY ALL MAIN INSTALLATION MODE



AUTODIMMER INTELLIGENTE DI SERIE PER LA GESTIONE AUTOMATICA DEL FLUSSO LUMINOSO
SMART LIGHT SENSOR INCLUDED STANDARD FOR AUTOMATIC LIGHT FLUX ADJUSTMENT



BS 100

illuminazione / lighting



WEB CATALOGUE



IP65

IK07
IK05

850°

+40°C
-20°C



Caratteristiche

Mantenimento flusso luminoso a 25°C
60.000 (L80B20)

Installazioni Plafone, sospensione, barra elettrificata

Corpo Policarbonato, RAL 7035

Optica Acciaio verniciato alle polveri di colore bianco riflettente

Conformità EN 60598-1, EN 60598-2-1, EN 60598-2-22, DIN 18032-3:1997-04, EN 62471 (Rischio fotobiologico esente), 2014/53/UE, EN60598-2-22

Applicazioni

Industriale, garage, palestre, aree esterne, aree soggette ad HACCP

Characteristics

Luminous flux retention at 25°C
60,000 (L80B20)

Mounting Ceiling, suspended, electrified track

Housing Polycarbonate, RAL 7035

Optics Reflective white powder-coated steel

Compliance EN 60598-1, EN 60598-2-1, EN 60598-2-22, DIN 18032-3:1997-04, EN 62471 (Photobiological risk-free), 2014/53/EU

Applications

Industry, car parks, gymnasiums, outdoor areas, HACCP areas

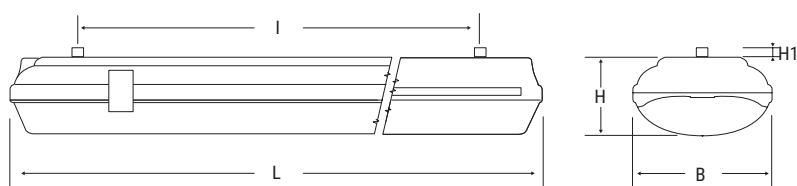

Taglia Size	Dimensioni Dimensions mm				
	L	B	H	H1	I
S	671	170	95	10	475
M	1280	170	95	10	660
L	1581	170	95	10	900

BS 100

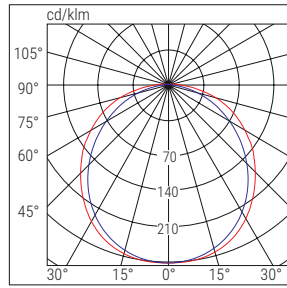

■ C180-C270 ■ C90-C270

BS 100 PARKING

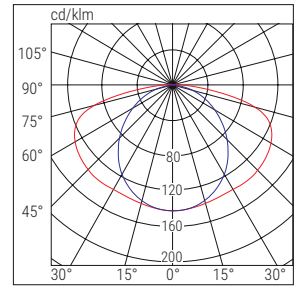

■ C0-C180 ■ C90-C270

	Taglia Size	Cod.	Descrizione Description	Potenza Power W	Temp. colore Colour Temp. K	CRI	Flusso LED LED Flux lm (Tj=25°C)	Flusso Flux lm	Efficienza Efficiency lm/W	Kg	Note
RD	S	40003H	BS100 LED REGOLABILE HV S670 4K	34	4000	>80	6300	5000	162	1.4	REGOLABILE
	M	40004H	BS100 LED REGOLABILE HV M1280 4K	51	4000	>80	9200	8000	179	2.3	
	L	40005H	BS100 LED REGOLABILE HV L1580 4K	63	4000	>80	11500	10000	171	2.7	
DALI	S	40043	BS100 LED S670 DALI 4K	40	4000	>80	6900	6000	150	1.4	DALI
	M	40044	BS100 LED M1280 DALI 4K	59	4000	>80	9800	8500	144	2.3	
	L	40045	BS100 LED L1580 DALI 4K	73	4000	>80	12700	11000	151	2.7	
SDB	S	40023	BS100 LED S670 SDB 4K	40	4000	>80	6900	6000	150	1.4	BLUETOOTH
	M	40024	BS100 LED M1280 SDB 4K	59	4000	>80	9800	8500	144	2.3	
	L	40025	BS100 LED L1580 SDB 4K	73	4000	>80	12700	11000	151	2.7	
	M	40033	BS100 LEDPARK M1280 SDB 4K	59	4000	>80	9800	8500	144	2.3	

VARIANTI CON DIVERSA TEMPERATURA COLORE (K) / VERSIONS WITH DIFFERENT COLOUR TEMPERATURES (K)

Gli apparecchi sono disponibili anche in versione **3000K e 6000K**. L'elenco dei codici relativi è visionabile nell'**Indice analitico**, in calce ai codici su indicati con 4000K
 The luminaires are also available in **3000K and 6000K** versions. A list of the related codes can be found in the **Analytical Index**, under the above codes with 4000K

RD FLUSSO-POTENZA REGOLABILI / ADJUSTABLE FLUX-POWER

	Flusso/Potenza Flux/Power	S			M			L		
		lm	W	lm/W	lm	W	lm/W	lm	W	lm/W
STEP 1		5000	34	147	8000	51	157	10000	63	159
STEP 2		4400	29	152	7000	43	163	8500	53	160
STEP 3		3850	24	160	6000	35	171	7500	44	170
STEP 4		3080	19	162	5000	28	179	6000	35	171

Driver RD dotato di switch con 4 step di modulazione della corrente in modo da assicurare la massima efficienza luminosa, e quindi il massimo risparmio energetico, utilizzando solo il flusso luminoso determinato in fase di progettazione / RD driver equipped with a switch with 4 steps of current modulation in order to ensure maximum luminous efficiency, and therefore maximum energy saving, using only the luminous flux determined in the design phase.

VARIANTI SPECIALI - a richiesta / SPECIAL VARIANTS - on request

TEMPERATURA COLORE 3000K e 6000K - RESA CROMATICA >90 - SENSORE DI PRESENZA A MICROONDE
 COLOUR TEMPERATURE 3000K and 6000K - CHROMATIC YIELD >90 - MICROWAVE MOTION SENSOR

BS 100

ACCESSORI - da ordinare separatamente / ACCESSORIES - to be ordered separately

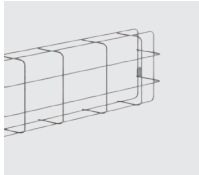

GRIGLIA DI PROTEZIONE PROTECTIVE GRILLE

Cod. **3905** Vers. S - 685 x 182 x 110 mm
Cod. **8063** Vers. M/L - 1700 x 291 x 135 mm

Nota di installazione / Installation note

Per il montaggio delle griglie con apparecchio installato su blindosbarra occorre utilizzare : Staffa **8063/1**

*When installing grilles with the luminaire installed on a bus bar, use: Bracket **8063/1***



KIT GANCI ACCIAIO / STEEL HOOK KIT

Solo per versione SD / Only SD version

Cod. **3505** Vers. S - 4 pezzi / pieces
Cod. **3506** Vers. M - 8 pezzi / pieces
Cod. **3507** Vers. L - 10 pezzi / pieces



STAFFE A PARETE WALL-MOUNTED BRACKETS

Cod. **3504**

SD ACCESSORI - da ordinare separatamente / ACCESSORIES - to be ordered separately



CENTRALE LOGICA LOGICA CONTROL UNIT

SD LGFM - Cod. **21102**



MODULI AUTODIMMER/RADIO IP65 IP65 AUTODIMMER/RADIO MODULES

AUTODIMMER - Cod. **15050**
AUTODIMMER + RADIO - Cod. **15051**



CONCENTRATORE WIFI BLUETOOTH WiFi BLUETOOTH CONCENTRATOR

1 ingresso di controllo / 1 control input

Cod. **15064**



MODULO INTERFACCIA BLUETOOTH BLUETOOTH MODULE INTERFACE

3 ingressi di controllo / 3 control inputs

Cod. **15065**



CONCENTRATORE BLUETOOTH EASY BOX BLUETOOTH EASY BOX CONCENTRATOR

WiFi - Cod. **15174**
WiFi ETHERNET - Cod. **15074**



SENSORE PRESENZA MOTION SENSOR

INDUSTR IP65 - Cod. **15063**
UFFICI IP40 - Cod. **15062**

Sistema di trasmissione wireless integrato che permette la comunicazione fra gli apparecchi in modo da realizzare gruppi che attuano gli stessi comandi senza aggiungere ulteriori cablaggi. Utilizzando il Modulo interfaccia Bluetooth è possibile comandare i gruppi in modalità wireless. Per gestire un impianto centralizzato da APP B.connect occorre integrare il Concentratore Bluetooth. *Integrated wireless transmission system for communication between luminaires in order to create groups with the same commands without adding further wiring. Using the Bluetooth Interface Module it is possible to control the groups wireless. To manage a centralized system from the B.connect APP, the Bluetooth concentrator must be integrated.*

EMERGENZA CON INVERTER LED - da ordinare separatamente EMERGENCY LED INVERTER - to be ordered separately



INVERTER PLUG&LIGHT SE/SA 1-3h 60-180V

Cod. **19367** (1h)
Cod. **19371** (3h)



BOOSTER BATTERY

Batteria LiFe 6.4V 1,5Ah - Raddoppia la Potenza (10W) e il Flusso luminoso (1600lm) in emergenza
LiFe 6.4V 1,5Ah Battery - Double the Power (10W) and the Emergency Flux (1600lm)

Cod. **RA13**



INVERTER UNIVERSALE 5W 20-240V

AT - Cod. **19398**
CT - Cod. **19399**



MODULO / MODULE LG - LGFM - DALI

Solo per Inverter CT / For CT Inverters only

LG - Cod. **15079**
LGFM - Cod. **15037**
DALI - Cod. **15080**



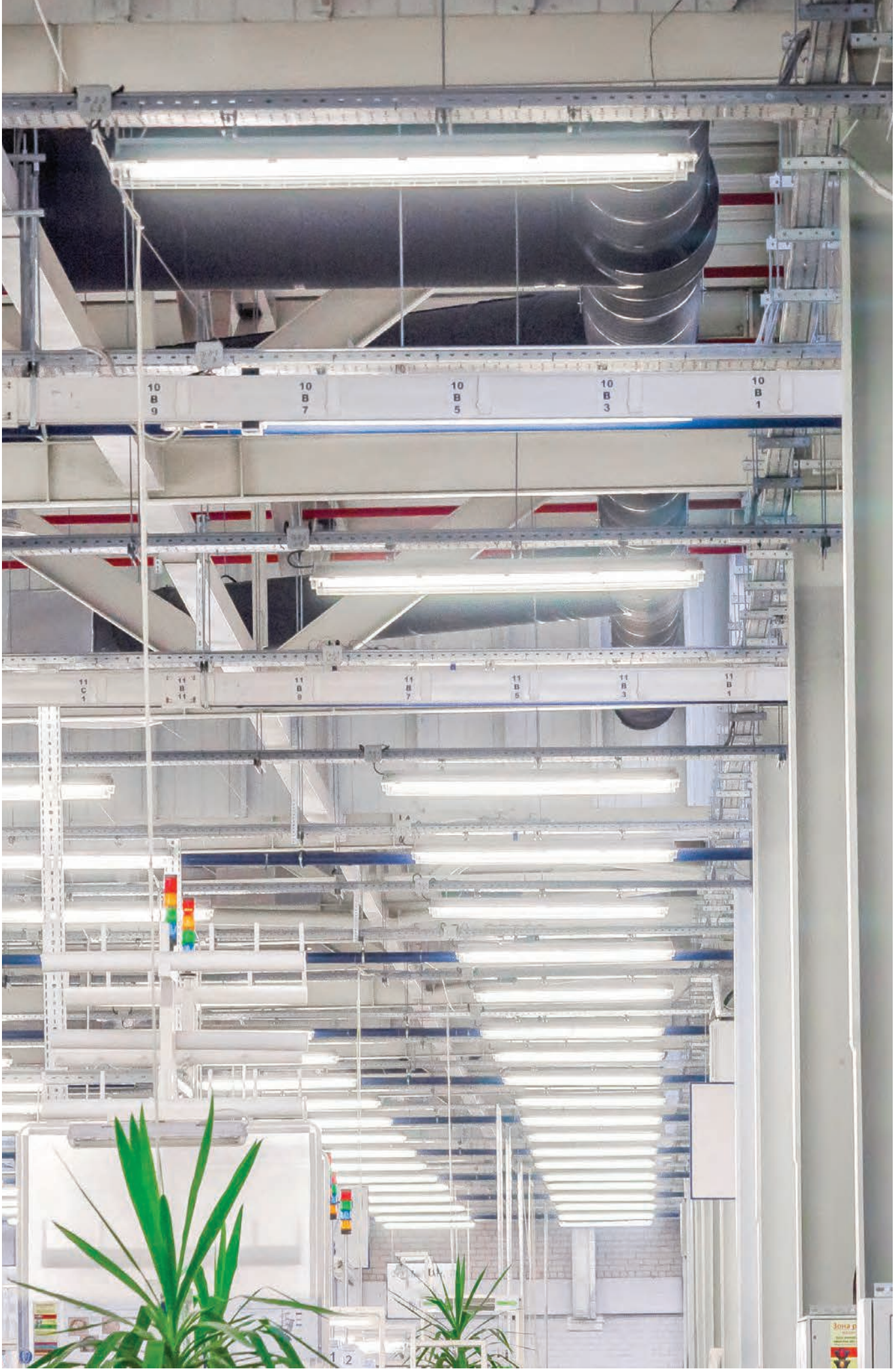

081 plafoniere stagne / waterproof ceiling lights

Acciaio



IP66

IK09

950°

+40°C
-20°C



Caratteristiche

Mantenimento flusso luminoso a 25°C

>60.000h (versioni 2x) (L80B20)

>70.000h (versioni 1x) (L80B20)

Installazioni Plafone, sospensione, barra elettrificata

Corpo Acciaio verniciato RAL7035

Ottica Celle in alluminio antiabbagliamento

Schermo Vetro temprato microprismatizzato

Conformità EN 60598-1, EN 60598-2-1, EN 60598-2-22, DIN 18031-3, EN 62471 (Rischio fotobiologico esente), ATEX 2014/34/UE, 2014/53/UE, EN60598-2-22

Applicazioni

Industriale per installazioni particolarmente gravose e ad alto rischio, ambienti outdoor

Characteristics

Luminous flux retention at 25°C

>60,000h (2x versions) (L80B20)

>70,000h (1x versions) (L80B20)

Mounting Ceiling, suspended, electrified track

Housing Painted steel, RAL7035

Optics Anti-glare aluminium cells

Screen Tempered glass prism

Compliance EN 60598-1, EN 60598-2-1, EN 60598-2-22, DIN 18031-3, EN 62471 (photobiological risk-free), ATEX 2014/34/EU, 2014/53/EU

Applications

Industry - for heavy-duty and high-risk installations, outdoor environments

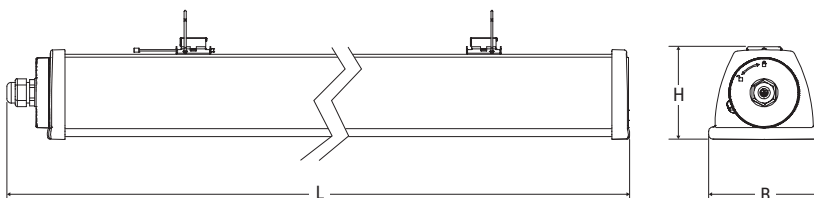

Taglia Size	Dimensioni Dimensions mm		
	L	B	H
S	667	108	90
M	1225	108	90
L	1565	108	90

ACCIAIO

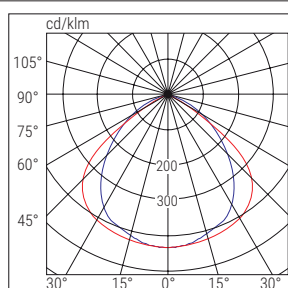

■ C0-C180 ■ C90-C270

	Taglia Size	Cod.	Descrizione Description	Potenza Power W	Temp. colore Colour Temp. K	CRI	Flusso LED LED Flux lm (Tj=25°C)	Flusso Flux lm	Efficienza Efficiency lm/W	Kg	Note
RD	S	A218RD	ACCIAIO REG 2X18W S600 4K	34	4000	>80	6300	5000	162	2	REGOLABILE
	M	A236RD	ACCIAIO REG 2X36W M1200 4K	38	4000	>80	6900	6000	176	3.2	
	M	A258RD	ACCIAIO REG 2X58W M1200 4K	51	4000	>80	9200	8000	175	3.2	
	L	A280RD	ACCIAIO REG 2X80W L1500 4K	63	4000	>80	11500	10000	171	3.9	
DALI	S	41233	ACCIAIO DALI S600 4K	41	4000	>80	6900	6000	146	2	DALI
	M	41237	ACCIAIO DALI M1200 4K	59	4000	>80	9800	8500	144	3.2	
	L	41241	ACCIAIO DALI L1500 4K	73	4000	>80	1300	11000	151	3.9	
SD	S	41221	ACCIAIO SDB S600 4K	41	4000	>80	6900	6000	146	2	BLUETOOTH
	M	41225	ACCIAIO SDB M1200 4K	59	4000	>80	9800	8500	144	3.2	
	L	41229	ACCIAIO SDB L1500 4K	73	4000	>80	1300	11000	151	3.9	

VARIANTI CON DIVERSA TEMPERATURA COLORE (K) / VERSIONS WITH DIFFERENT COLOUR TEMPERATURES (K)

Gli apparecchi sono disponibili anche in versione **3000K, 5000K e 6000K**. L'elenco dei codici relativi è visionabile nell'**Indice analitico**, in calce ai codici su indicati con 4000K
The luminaires are also available in **3000K, 5000K and 6000K** versions. A list of the related codes can be found in the **Analytical Index**, under the above codes with 4000K

RD FLUSSO-POTENZA REGOLABILI / ADJUSTABLE FLUX-POWER

	Flusso Potenza Flux Power	Cod. A218RD			Cod. A236RD			Cod. A258RD			Cod. A280RD		
		lm	W	lm/W	lm	W	lm/W	lm	W	lm/W	lm	W	lm/W
STEP 1	5000	34	147	6000	38	158	8000	51	157	10000	63	159	
STEP 2	4400	29	152	5400	32	169	7000	43	163	8700	53	164	
STEP 3	3850	24	160	4400	26	169	6000	35	171	7400	44	168	
STEP 4	3080	19	162	3700	21	176	4900	28	175	6000	35	171	

Driver RD dotato di switch con 4 step di modulazione della corrente in modo da assicurare la massima efficienza luminosa, e quindi il massimo risparmio energetico, utilizzando solo il flusso luminoso determinato in fase di progettazione / RD driver equipped with a switch with 4 steps of current modulation in order to ensure maximum luminous efficiency, and therefore maximum energy saving, using only the luminous flux determined in the design phase.

VARIANTI SPECIALI - a richiesta / SPECIAL VARIANTS - on request

RESA CROMATICA ≥ 90 - TEMPERATURA COLORE - PASSANTE ELETTRIFICATO TRIFASE - DIFFUSORE IN POLICARBONATO (HACCP)
CHROMATIC YIELD ≥ 90 - COLOUR TEMPERATURE - THREE-PHASE ELECTRIFIED FEED-THROUGH - POLYCARBONATE DIFFUSER (HACCP)

Acciaio

ACCESSORI - da ordinare separatamente / ACCESSORIES - to be ordered separately



PROTEZIONE HCCP 1200 - 1500
HCCP PROTECTION 1200 - 1500

Cod. **20107** (1200) - **20113** (1500)



STAFFA ORIENTABILE
SWIVEL BRACKET

2 pezzi / 2 pieces

Cod. **20122**



RACCORDO DOPPIO INGRESSO M20
DOUBLE INLET FITTING M20

Cod. **15019**



KIT ATEX ACCIAIO / ATEX STEEL KIT

Incluso nella versione 2x80. Non compatibile con gli Inverter emergenza / Included in the 2x80 version. Not installable on emergency Inverter

Cod. **15018**

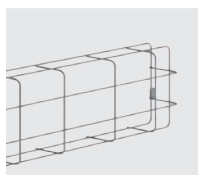

GRIGLIA DI PROTEZIONE / PROTECTIVE GRILLE

Nota di installazione - Per il montaggio delle griglie con apparecchio installato su blindosbarra occorre utilizzare : Staffa **8063/1**
Installation note - When installing grilles with the luminaire installed on a bus bar, use: Bracket **8063/1**

Cod. **8063** Vers. M/L - 1700 x 291 x 135 mm

SD ACCESSORI - da ordinare separatamente / ACCESSORIES - to be ordered separately



CENTRALE LOGICA
LOGICA CONTROL UNIT

SD LGFM - Cod. **21102**



MODULI AUTODIMMER/RADIO IP65
IP65 AUTODIMMER/RADIO MODULES

AUTODIMMER - Cod. **15050**
AUTODIMMER + RADIO - Cod. **15051**



CONCENTRATORE WIFI BLUETOOTH
WiFi BLUETOOTH CONCENTRATOR

1 ingresso di controllo / 1 control input

Cod. **15064**



MODULO INTERFACCIA BLUETOOTH
BLUETOOTH MODULE INTERFACE

3 ingressi di controllo / 3 control inputs

Cod. **15065**



CONCENTRATORE BLUETOOTH EASY BOX
BLUETOOTH EASY BOX CONCENTRATOR

WiFi - Cod. **15174**
WiFi ETHERNET - Cod. **15074**



SENSORE PRESENZA
MOTION SENSOR

INDUSTR IP65 - Cod. **15063**
UFFICI IP40 - Cod. **15062**

Sistema di trasmissione wireless integrato che permette la comunicazione fra gli apparecchi in modo da realizzare gruppi che attuano gli stessi comandi senza aggiungere ulteriori cablaggi. Utilizzando il Modulo interfaccia Bluetooth è possibile comandare i gruppi in modalità wireless. Per gestire un impianto centralizzato da APP B.connect occorre integrare il Concentratore Bluetooth. *Integrated wireless transmission system for communication between luminaires in order to create groups with the same commands without adding further wiring. Using the Bluetooth Interface Module it is possible to control the groups wireless. To manage a centralized system from the B.connect APP, the Bluetooth concentrator must be integrated.*

EMERGENZA CON INVERTER LED - da ordinare separatamente - solo per versione M-L
EMERGENCY LED INVERTER - to be ordered separately - only M-L version



INVERTER UNIVERSALE 5W 20-240V

AT - Cod. **19398**
CT - Cod. **19399**

AT CT



INVERTER PLUG&LIGHT SE/SA 1-3h 60-180V

Cod. **19367** (1h)
Cod. **19371** (3h)

TR



BOOSTER BATTERY

Batteria LiFe 6.4V 1,5Ah - Raddoppia la Potenza (10W) e il Flusso luminoso (1600lm) in emergenza
LiFe 6.4V 1,5Ah Battery - Double the Power (10W) and the Emergency Flux (1600lm)

Cod. **RA13**



MODULO / MODULE LG - LGFM - DALI

Solo per Inverter CT / For CT Inverters only

LG - Cod. **15079**
LGFM - Cod. **15037**
DALI - Cod. **15080**

LG

LGFM

DALI



085 plafoniere stagne / waterproof ceiling lights

Acciaio Extreme

illuminazione / lighting



IP66

IK09

950°

+40°C
-20°C



Caratteristiche

Mantenimento flusso luminoso a 25°C
>60.000h (L80B20)

Installazioni Plafone, sospensione, barra elettrificata

Corpo Acciaio Inox Aisi 304

Ottica Antiabbagliamento a celle in alluminio

Schermo Vetro temprato microprismatizzato

Conformità EN 60598-1, EN 60598-2-1, EN 60598-2-22, DIN 18031-3, EN 62471 (Rischio fotobiologico esente), ATEX 2014/34/UE (Zone 02 e 22), 2014/53/UE, EN60598-2-22

Applicazioni

Industriale, anche outdoor, per installazioni particolarmente gravose e ad alto rischio, resistente anche alle vibrazioni meccaniche e alle perturbazioni elettromagnetiche

Characteristics

Luminous flux retention at 25°C

>60,000h (L80B20)

Mounting Ceiling, suspended, electrified track

Housing Stainless Steel AISI 304

Optics Anti-glare aluminium cells

Screen Tempered glass prism

Compliance EN 60598-1, EN 60598-2-1, EN 60598-2-22, DIN 18031-3, EN 62471 (photobiological risk-free), ATEX 2014/34/EU (Zone 02 and 22), 2014/53/EU

Applications

Industry, also outdoor, for particularly heavy and high-risk systems, also resistant to mechanical vibrations and electromagnetic disturbances

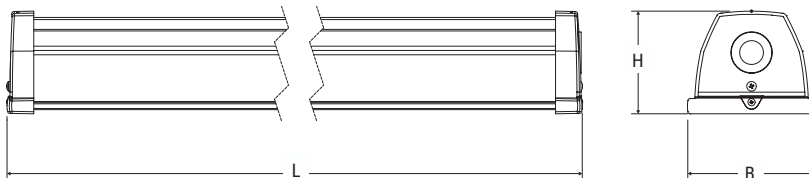

Taglia Size	Dimensioni Dimensions mm		
	L	B	H
M	1199	109	88
L	1484	109	88

ACCIAIO EXTREME

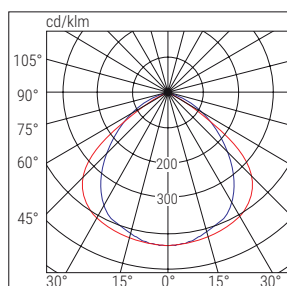
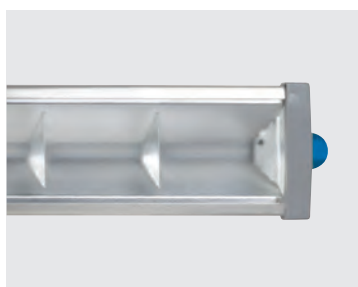

■ C90-C270 ■ C0-C180

	Taglia Size	Cod.	Descrizione Description	Potenza Power W	Temp. colore Colour Temp. K	CRI	Flusso LED LED Flux lm (Tj=25°C)	Flusso Flux lm	Efficienza Efficiency lm/W	Kg	Note
DALI	M	41260	ACCIAIO EX LED 2X36 DALI 4K	35	4000	>80	5400	4700	134	3.3	⚡
	M	41263	ACCIAIO EX LED 2X58 DALI 4K	52	4000	>80	8100	7000	135	3.3	⚡
	L	41266	ACCIAIO EX LED 2X80 DALI 4K	74	4000	>80	11400	9900	134	4	⚡
SDB	M	41251	ACCIAIO EX LED 2X36 SDB 4K	35	4000	>80	5400	4700	134	3.3	⚡
	M	41254	ACCIAIO EX LED 2X58 SDB 4K	52	4000	>80	8100	7000	135	3.3	⚡
	L	41257	ACCIAIO EX LED 2X80 SDB 4K	74	4000	>80	11400	9900	134	4	⚡

VARIANTI CON DIVERSA TEMPERATURA COLORE (K) / VERSIONS WITH DIFFERENT COLOUR TEMPERATURES (K)

Gli apparecchi sono disponibili anche in versione **3000K e 6000K**. L'elenco dei codici relativi è visionabile nell'**Indice analitico**, in calce ai codici su indicati con 4000K
 The luminaires are also available in **3000K and 6000K** versions. A list of the related codes can be found in the **Analytical Index**, under the above codes with 4000K

VARIANTI SPECIALI - a richiesta / SPECIAL VARIANTS - on request

RESA CROMATICA ≥90 - TEMPERATURA COLORE A RICHIESTA - VERSIONE CON DIFFUSORE IN POLICARBONATO PER AMBIENTI HACCP
CHROMATIC YIELD ≥90 - COLOUR TEMPERATURE ON REQUEST - VERSION WITH POLYCARBONATE DIFFUSER FOR HACCP ENVIRONMENTS

ACCESSORI - in dotazione / ACCESSORIES - included



PRESSACAVO ATEX - KIT PASSANTE
ATEX CABLE GLAND - FEED-THROUGH KIT

ACCESSORI - da ordinare separatamente / ACCESSORIES - to be ordered separately

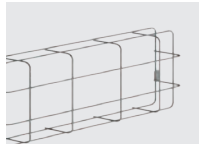

GRIGLIA DI PROTEZIONE
PROTECTIVE GRILLE

Cod. **8063** Vers. M/L - 1700 x 291 x 135 mm

Nota di installazione

Per il montaggio delle griglie con apparecchio installato su blindosbarra occorre utilizzare: Staffa **8063/1**

Installation note

To mount grilles with the luminaire installed on a bus bar, use: Bracket **8063/1**



RACCORDO DOPPIO INGRESSO M20
DOUBLE INLET FITTING M20

Cod. **15019**



STAFFA PALO
POLE BRACKET

Cod. **20125**











STAFFA ORIENTABILE
SWIVEL BRACKET

Cod. **20123**

SEGUE / NEXT >











Acciaio Extreme

SD  **ACCESSORI** - da ordinare separatamente / **ACCESSORIES** - to be ordered separately

	<p>CENTRALE LOGICA <i>LOGICA CONTROL UNIT</i></p> <p>SD LGFM - Cod. Ord. 21102</p>		<p>MODULI AUTODIMMER/RADIO IP65 <i>IP65 AUTODIMMER/RADIO MODULES</i></p> <p>AUTODIMMER - Cod. 15050 AUTODIMMER + RADIO - Cod. 15051</p>
	<p>CONCENTRATORE WIFI BLUETOOTH <i>WiFi BLUETOOTH CONCENTRATOR</i></p> <p>1 ingresso di controllo / 1 control input</p> <p>Cod. 15064</p> 		<p>MODULO INTERFACCIA BLUETOOTH <i>BLUETOOTH MODULE INTERFACE</i></p> <p>3 ingressi di controllo / 3 control inputs</p> <p>Cod. 15065</p> 
	<p>CONCENTRATORE BLUETOOTH EASY BOX <i>BLUETOOTH EASY BOX CONCENTRATOR</i></p> <p>WiFi - Cod. 15174 WiFi ETHERNET - Cod. 15074</p> 		<p>SENSORE PRESENZA <i>MOTION SENSOR</i></p> <p>INDUSTR IP65 - Cod. 15063 UFFICI IP40 - Cod. 15062</p>

Sistema di trasmissione wireless integrato che permette la comunicazione fra gli apparecchi in modo da realizzare gruppi che attuano gli stessi comandi senza aggiungere ulteriori cablaggi. Utilizzando il Modulo interfaccia Bluetooth è possibile comandare i gruppi in modalità wireless. Per gestire un impianto centralizzato da APP B.connect occorre integrare il Concentratore Bluetooth. *Integrated wireless transmission system for communication between luminaires in order to create groups with the same commands without adding further wiring. Using the Bluetooth Interface Module it is possible to control the groups wireless. To manage a centralized system from the B.connect APP, the Bluetooth concentrator must be integrated.*

EMERGENZA CON INVERTER LED - da ordinare separatamente - non idoneo in ambienti Atex EMERGENCY LED INVERTER - to be ordered separately - not right for Atex environments

	<p>INVERTER UNIVERSALE 5W 20-240V</p> <p>AT - Cod. 19398 CT - Cod. 19399</p>  		<p>INVERTER PLUG&LIGHT SE/SA 1-3h 60-180V</p> <p>Cod. 19367 (1h) Cod. 19371 (3h)</p> 
	<p>BOOSTER BATTERY</p> <p>Batteria LiFe 6.4V 1,5Ah - Raddoppia la Potenza (10W) e il Flusso luminoso (1600lm) in emergenza <i>LiFe 6.4V 1,5Ah Battery - Double the Power (10W) and the Emergency Flux (1600lm)</i></p> <p>Cod. RA13</p>		<p>MODULO / MODULE LG - LGFM - DALI Solo per Inverter CT / For CT Inverters only</p> <p>LG - Cod. 15079 LGFM - Cod. 15037 DALI - Cod. 15080</p>   

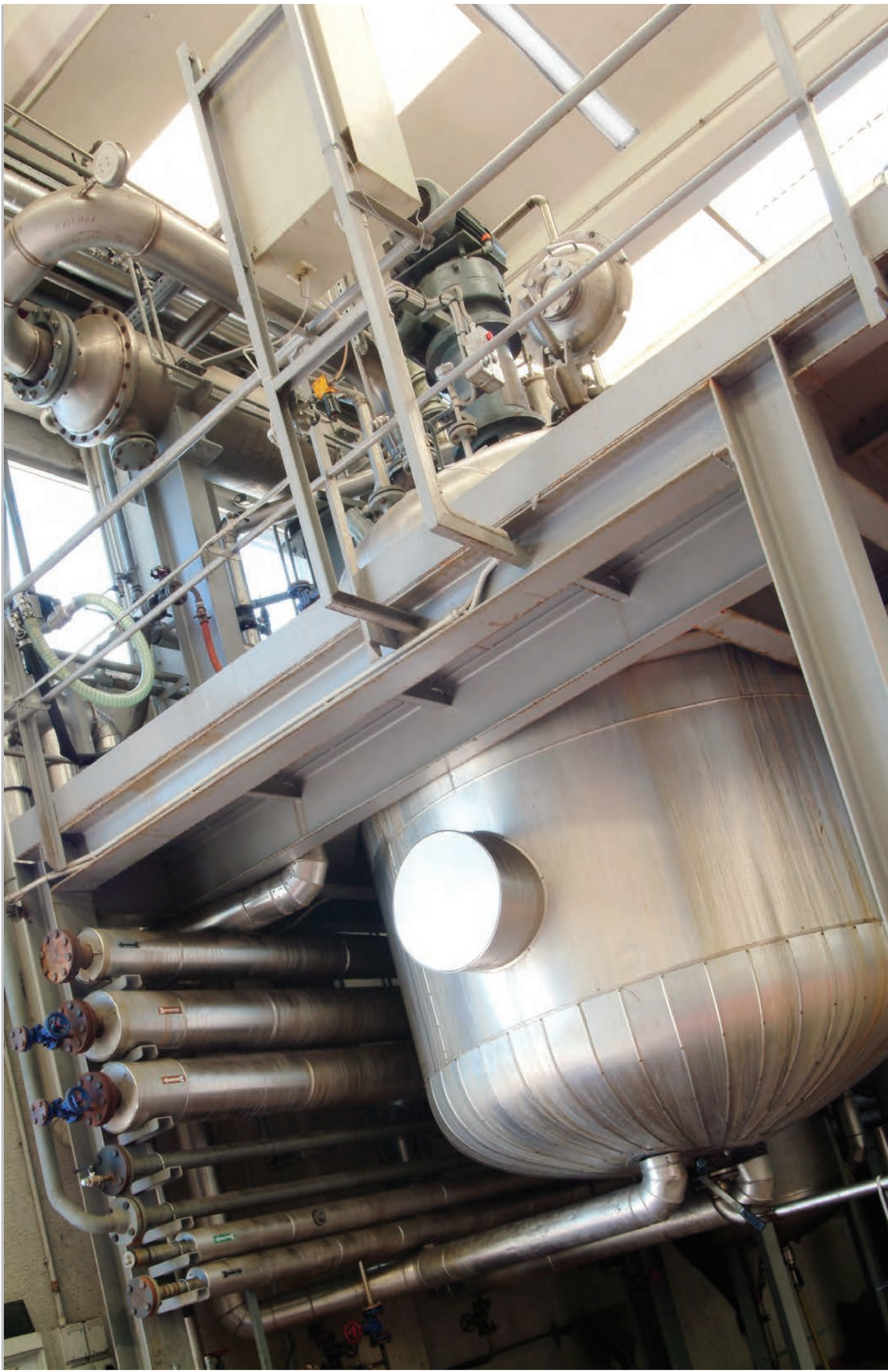

089 plafoniere stagne / waterproof ceiling lights

Saving Stagna Led

illuminazione / lighting



IP65

IK05

850°

+40°C
-20°C

Caratteristiche

Mantenimento flusso luminoso a 25°C
>60.000h (L80B20)

Installazioni Plafone, sospensione, barra elettrificata

Corpo Policarbonato, RAL 7035

Ottica Acciaio verniciato alle polveri di colore bianco riflettente

Schermo Policarbonato trasparente opalino

Conformità EN60598-1, EN60598-2-1, EN 60598-2-22, EN 62471

Applicazioni

Industriale, terziario, magazzini, garage

Characteristics

Luminous flux retention at 25°C
>60.000h (L80B20)

Mounting Ceiling, suspended, electrified track

Housing Polycarbonate, RAL 7035

Optics White painted steel

Screen Opal Polycarbonate

Compliance EN60598-1, EN60598-2-1, EN 60598-2-22, EN 62471

Applications

Industry, services sector, warehouses, car parks

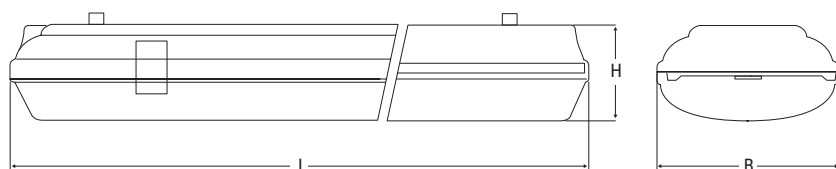

Taglia Size	Dimensioni Dimensions mm		
	L	B	H
S	677	121	82
M	1264	121	82
L	1567	121	82

090

SAVING STAGNA LED

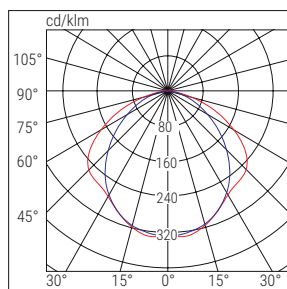

■ C0-C180 ■ C90-C270

LED AD ALTA EFFICIENZA / HIGH EFFICIENCY LED

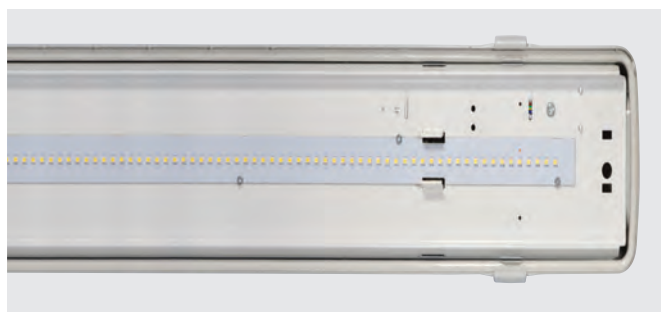

Taglia Size	Cod.	Descrizione Description	Potenza Power W	Temp. colore Colour Temp. K	CRI	Flusso LED LED Flux lm (Tj=25°C)	Flusso Flux lm	Efficienza Efficiency lm/W	Kg	
LED	S	72030	SAVING IP65 LED 218 3K	19	3000	>80	3300	2850	150	1.4
	S	72031	SAVING IP65 LED 218 4K	19	4000	>80	3500	3000	158	1.4
	S	72032	SAVING IP65 LED 218 6K	19	6000	>80	3500	3000	158	1.4
	M	72008	SAVING IP65 LED 236 3K	28	3000	>80	4900	4300	154	2.1
	M	72010	SAVING IP65 LED 236 4K	28	4000	>80	5200	4500	161	2.1
	M	72012	SAVING IP65 LED 236 6K	28	6000	>80	5200	4500	161	2.1
	M	72009	SAVING IP65 LED 258 3K	42	3000	>80	7100	6200	148	2.1
	M	72011	SAVING IP65 LED 258 4K	42	4000	>80	7500	6500	155	2.1
	M	72013	SAVING IP65 LED 258 6K	42	6000	>80	7500	6500	155	2.1
	L	72040	SAVING IP65 LED 258 GL 3K	53	3000	>80	8200	7150	135	2.7
	L	72041	SAVING IP65 LED 258 GL 4K	53	4000	>80	8600	7500	142	2.7
	L	72042	SAVING IP65 LED 258 GL 6K	53	6000	>80	8600	7500	142	2.7

ON / OFF

ACCESSORI - in dotazione / ACCESSORIES - included



ACCESSORI - da ordinare separatamente / ACCESSORIES - to be ordered separately



Nota di installazione / Installation note

Per il montaggio delle griglie con apparecchio installato su blindosbarra occorre utilizzare : Staffa **8063/1**

When installing grilles with the luminaire installed on a bus bar, use: Bracket **8063/1**

EMERGENZA CON INVERTER LED - da ordinare separatamente - non idoneo in ambienti Atex

EMERGENCY LED INVERTER - to be ordered separately - not right for Atex environments

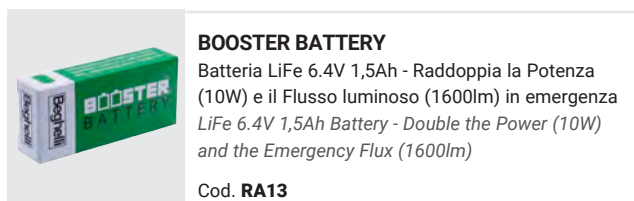
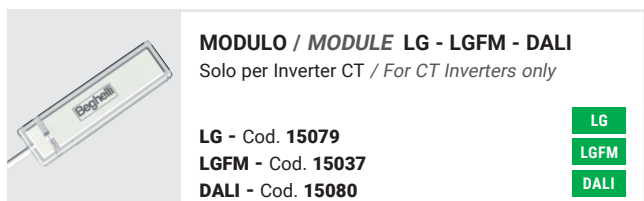
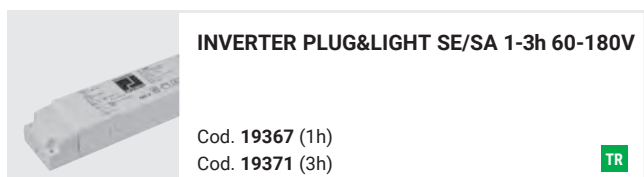

091 plafoniere stagne / waterproof ceiling lights

Saving Stagna TubiLED

illuminazione / lighting



Caratteristiche

Mantenimento flusso luminoso a 25°C
>30.000h (L80B20)

Installazioni Plafone, sospensione, barra elettrificata

Corpo Policarbonato, RAL 7035

Ottica Acciaio verniciato alle polveri di colore bianco riflettente

Schermo Policarbonato opalino

Attacco G13

Sorgente luminosa Tubi LED (in dotazione)

Conformità EN60598-1, EN60598-2-1, EN 62471

Applicazioni

Industriale, terziario, magazzini, garage

Characteristics

Luminous flux retention at 25°C
>30.000h (L80B20)

Mounting Ceiling, suspended, electrified track

Housing Polycarbonate, RAL 7035

Optics White painted steel

Screen Opal Polycarbonate

Lamp connection G13

Lamp LED tubes (included)

Compliance EN60598-1, EN60598-2-1, EN 62471

Applications

Industry, services sector, warehouses, car parks

IP65

IK05

850°

+40°C
-20°C

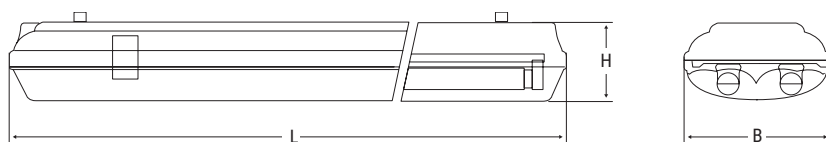

Taglia Size	Dimensioni Dimensions mm		
	L	B	H
S	674	121	82
M	1264	121	82
L	1564	121	82

092

SAVING STAGNA TUBILED

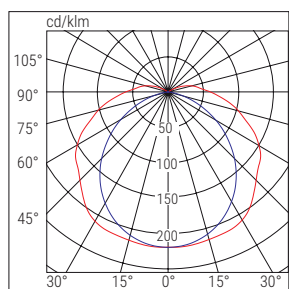

■ C0-C180

■ C90-C270

RIFLETTORE CON TUBI LED INSTALLATI



Taglia Size	Cod.	Descrizione Description	Potenza Power W	Temp. colore Colour Temp. K	CRI	Flusso LED LED Flux lm (Tj=25°C)	Flusso Flux lm	Efficienza Efficiency lm/W	Kg	
ED	S	72015	SAVING IP65 TUBI LED 118 4K	9	4000	>80	1000	800	90	1.4
	S	72001	SAVING IP65 TUBI LED 218 4K	18	4000	>80	2000	1600	90	1.4
	M	72016	SAVING IP65 TUBI LED 136 4K	18	4000	>80	2000	1700	95	2.6
	M	72003	SAVING IP65 TUBI LED 236 4K	36	4000	>80	4000	3400	94	2.6
	L	72017	SAVING IP65 TUBI LED 158 4K	24	4000	>80	2800	2300	95	3.3
	L	72005	SAVING IP65 TUBI LED 258 4K	58	4000	>80	5400	4600	96	3.3
	S	72002	SAVING IP65 TUBI LED 218 6.5K	18	6500	>80	2000	3700	100	1.4
	M	72004	SAVING IP65 TUBI LED 236 6.5K	36	6500	>80	4000	3700	100	2.6
	L	72006	SAVING IP65 TUBI LED 258 6.5K	58	6500	>80	5400	3700	100	3.3

Avvertenza: le caratteristiche dichiarate sono relative a un apparecchio provvisto con lampade originali in dotazione (TubiLED Beghelli) / Warning: the declared characteristics relate to a device equipped with original lamps supplied (TubiLED Beghelli)

ACCESSORI - in dotazione / ACCESSORIES - included



PRESSACAVO M20
M20 CABLE GLAND



**STAFFA DI FISSAGGIO
E GANCIO DI SOSPENSIONE**
MOUNTING BRACKET
AND SUSPENDED CEILING HOOKS

ACCESSORI - da ordinare separatamente / ACCESSORIES - to be ordered separately

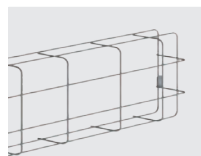

GRIGLIA DI PROTEZIONE
PROTECTIVE GRILLE

Cod. **3905** Vers. S - 685 x 182 x 110 mm
Cod. **8063** Vers. M/L - 1700 x 291 x 135 mm

Nota di installazione / Installation note

Per il montaggio delle griglie con apparecchio installato su blindosbarra occorre utilizzare : Staffa **8063/1**

When installing grilles with the luminaire installed on a bus bar, use: Bracket **8063/1**

Saving Stagna Slim

illuminazione / lighting



WEB
CATALOGUE

IP65

IK07

850°

+40°C
-20°C

Caratteristiche

Mantenimento flusso luminoso a 25°C

>25.000h (L80B20)

Installazioni Plafone

Corpo Policarbonato grigio RAL 7040

Ottica Policarbonato bianco

Schermo Policarbonato opalino
diffondente

Conformità EN 60598-1, EN 60598-2-1,
EN 60598-2-22, DIN 18032-3:1997-04,
EN 62471 (Rischio fotobiologico esente),
2014/53/UE, EN60598-2-22

Applicazioni

Industriale, terziario, magazzini, garage

Characteristics

Luminous flux retention at 25°C

>25.000h (L80B20)

Mounting Ceiling

Housing Polycarbonate, RAL 7040 grey

Optics White Polycarbonate

Screen Diffusing opal polycarbonate

Compliance EN 60598-1, EN 60598-2-1,
EN 60598-2-22, DIN 18032-3:1997-04,
EN 62471 (Rischio fotobiologico esente),
2014/53/UE, EN60598-2-22

Applications

Industry, services sector, sector,
warehouses, car parks

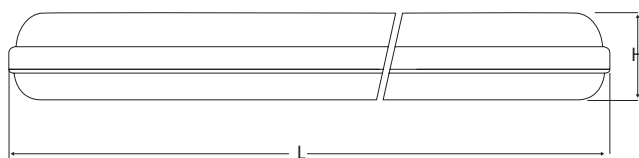

W	Dimensioni Dimensions mm		
	L	B	H
18	673	85	70
38	1273	85	70
58	1573	85	70

SAVING STAGNA SLIM

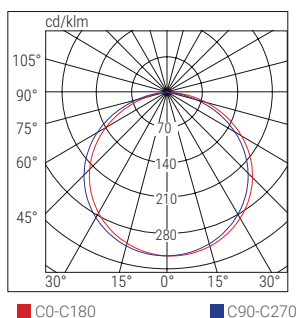

Versione Version	Cod.	Descrizione Description	Potenza Power W	Temp. colore Colour Temp. K	CRI	Flusso LED LED Flux lm (Tj=25°C)	Flusso Flux lm	Efficienza Efficiency lm/W	Kg	
ED	18W	75463	SAVING SLIM 60 IP65 18W 4K	18	4000	>80	2400	1980	110	0.9
	38W	75464	SAVING SLIM 120 IP65 38W 4K	38	4000	>80	5000	4180	110	1.5
	58W	75465	SAVING SLIM 150 IP65 58W 4K	58	4000	>80	7100	6380	110	1.9
	18W	75466	SAVING SLIM 60 IP65 18W 6.5K	18	6500	>80	2400	1980	110	0.9
	38W	75467	SAVING SLIM 120 IP65 38W 6.5K	38	6500	>80	5000	4180	110	1.5
	58W	75468	SAVING SLIM 150 IP65 58W 6.5K	58	6500	>80	7100	6380	110	1.9

ON / OFF

EMERGENZA CON INVERTER LED - da ordinare separatamente - non idoneo in ambienti Atex EMERGENCY LED INVERTER - to be ordered separately - not right for Atex environments



INVERTER PLUG&LIGHT SE/SA 1-3h 60-180V

Solo per versioni 38W e 58W
For only 38W and 58W version

Cod. **19367** (1h)
Cod. **19371** (3h)

TR



INVERTER UNIVERSALE 5W 20-240V

Solo per versioni 38W e 58W
For only 38W and 58W version

AT - Cod. **19398**
CT - Cod. **19399**

AT CT



MODULO / MODULE LG - LGFM - DALI

Solo per Inverter CT / For CT Inverters only

LG - Cod. **15079**
LGFM - Cod. **15037**
DALI - Cod. **15080**

LG
LGFM
DALI



BOOSTER BATTERY

Batteria LiFe 6.4V 1,5Ah - Raddoppia la Potenza (10W) e il Flusso luminoso (1600lm) in emergenza
LiFe 6.4V 1,5Ah Battery - Double the Power (10W) and the Emergency Flux (1600lm)

Cod. **RA13**

Stagna Easy Led



IP65

IK05

650°

 +40°C
-20°C

FLICKER FREE

Caratteristiche

Mantenimento flusso luminoso a 25°C
>25.000h (L80B20)

Installazioni Plafone, sospensione

Corpo Policarbonato, RAL 7035

Ottica Policarbonato bianco

Schermo Policarbonato opalino

Temperatura colore 4000K, 6500K

Conformità EN60598-1, EN60598-2-1,
EN 62471

Applicazioni

Terziario, piccoli magazzini, garage.

Non idoneo per uso intensivo

Characteristics

Luminous flux retention at 25°C

>25.000h (L80B20)

Mounting Plafone, suspended

Housing Polycarbonate, RAL 7035

Optics White Polycarbonate

Screen Opal Polycarbonate

Compliance EN60598-1, EN60598-2-1,
EN 62471

Applications

Services sector, warehouses, car parks.

Not suitable for intensive use

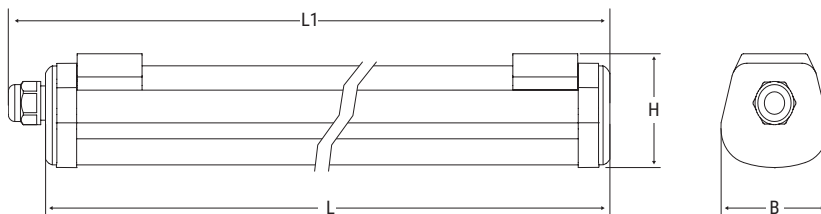

W	Dimensioni Dimensions mm			
	L	L1	B	H
15	600	638	52	61
30	1200	1238	52	61
40	1500	1538	52	61

STAGNA EASY LED

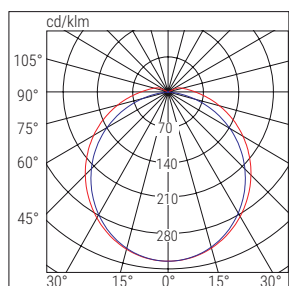

■ C0-C180 ■ C90-C270

Versione Version	Cod.	Descrizione Description	Potenza Power W	Temp. colore Colour Temp. K	CRI	Flusso LED LED Flux lm (Tj=25°C)	Flusso Flux lm	Efficienza Efficiency lm/W	Kg	
LED	15W	75450	STAGNALED ES-600 15W 4K 1800LM	15	4000	>80	2200	1800	120	0.9
	30W	75451	STAGNALED ES-1200 30W 4K 3600LM	30	4000	>80	4300	3600	120	1.5
	40W	75452	STAGNALED ES-1500 40W 4K 4800LM	40	4000	>80	5700	4800	120	1.9
	15W	75453	STAGNALED ES-600 15W 6.5K 1800LM	15	6500	>80	2200	1800	120	0.9
	30W	75454	STAGNALED ES-1200 30W 6.5K 3600LM	30	6500	>80	4300	3600	120	1.5
	40W	75455	STAGNALED ES-1500 40W 6.5K 4800LM	40	6500	>80	5700	4800	120	1.9

ON / OFF

ACCESSORI - in dotazione / ACCESSORIES - included



PRESSATUBO PG13.5
PG13.5 CABLE GLAND



STAFFE DI FISSAGGIO
FIXING BRACKETS



097 plafoniere stagne / waterproof ceiling lights

Stagna Easy CCT

illuminazione / lighting



WEB
CATALOGUE



IP65

IK08

650°



+40°C
-20°C

Caratteristiche

Mantenimento flusso luminoso a 25°C

>35.000h (L80B20)

Installazioni Plafone, sospensione

Corpo Policarbonato, RAL 9003

Ottica Policarbonato bianco

Schermo Policarbonato opalino

Temperatura colore 4000K, 6500K

Conformità EN60598-1, EN60598-2-1,
EN 62471

Applicazioni

Terziario, piccoli magazzini, garage.

Non idoneo per uso intensivo

Characteristics

Luminous flux retention at 25°C

>25.000h (L80B20)

Mounting Plafone, suspended

Housing Polycarbonate, RAL 9003

Optics White Polycarbonate

Screen Opal Polycarbonate

Compliance EN60598-1, EN60598-2-1,
EN 62471

Applications

Services sector, warehouses, car parks.

Not suitable for intensive use

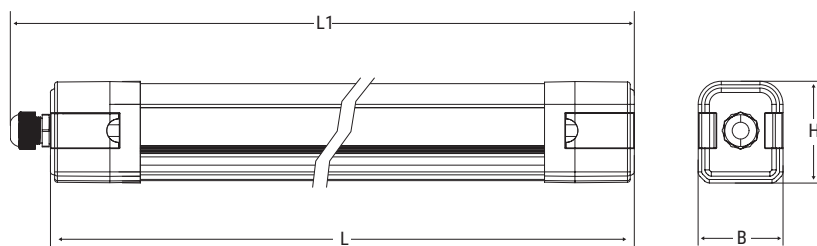

W	Dimensioni Dimensions mm			
	L	L1	B	H
20	600	630	61	74
40	1200	1230	61	74
55	1500	1530	61	74

098

STAGNA EASY CCT

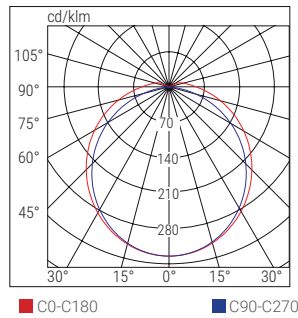
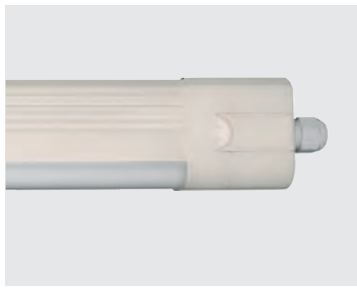

Cod.	Descrizione Description	Potenza Power W	Temp. colore Colour Temp. K	CRI	Flusso LED LED Flux lm (Tj=25°C)	Flusso Flux lm	Efficienza Efficiency lm/W	Kg
75460	STAGNALED CCT IP65 60CM 20W	20	CCT 3000-4000-6500	>80	2600	2200	110	0.5
75461	STAGNALED CCT IP65 120CM 40W	40	CCT 3000-4000-6500	>80	5100	4400	110	0.8
75462	STAGNALED CCT IP65 150CM 55W	55	CCT 3000-4000-6500	>80	6950	6050	110	1

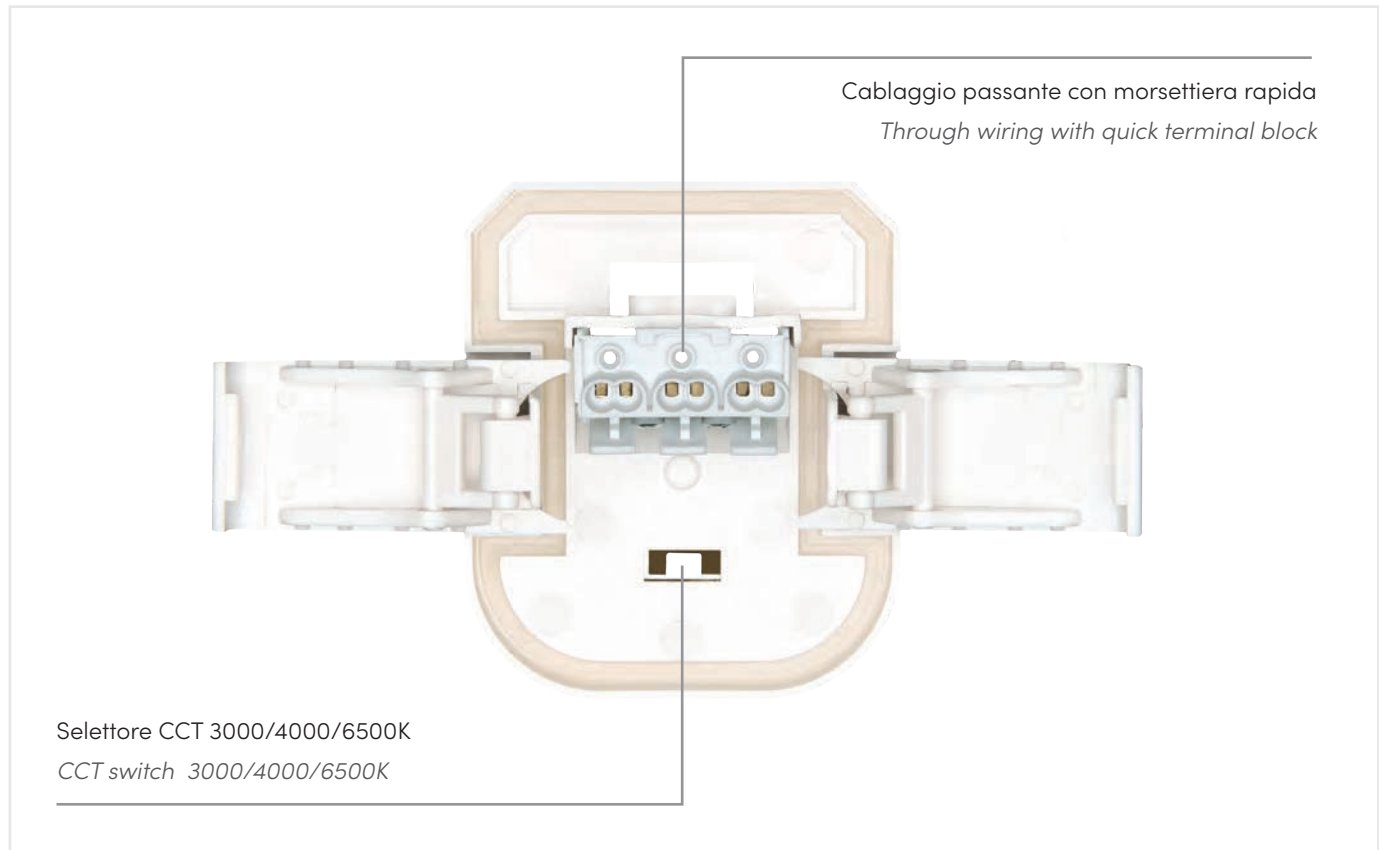

ACCESSORI - in dotazione / ACCESSORIES - included



PRESSACAVO PG13.5
CABLE GLAND PG13.5

H-PRO Modula



WEB CATALOGUE



IP66

IK08

960°

+40°C
-20°C



Caratteristiche

Mantenimento flusso luminoso a 25°C

>60.000h (240W) (L80B20)

>70.000h (150W) (L80B20)

Installazioni Suolo, parete

Corpo Alluminio pressofuso verniciato, RAL 7040

Ottica Alluminio brillantato antiiridescente

Schermo Vetro temprato

Conformità EN 60598-1, EN 60598-2-1, EN 60598-2-22, DIN 18031-3, EN 62471 (rischio biologico esente), 2014/53/UE, EN60598-2-22

Applicazioni

Industriale

Characteristics

Luminous flux retention at 25°C

>60.000h (240W) (L80B20)

>70.000h (150W) (L80B20)

Mounting Floor, wall

Housing Die-cast aluminium, RAL 7040

Optics Anti-iridescent polished aluminium

Screen Tempered glass prism

Compliance EN 60598-1, EN 60598-2-1, EN 60598-2-22, DIN 18031-3, EN 62471 (rischio biologico esente), 2014/53/UE, EN60598-2-22

Applications

Industry

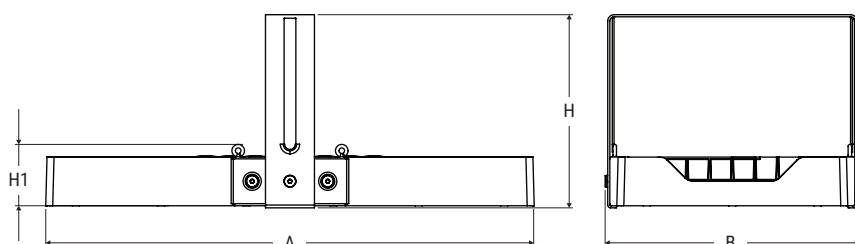

Dimensioni Dimensions mm			
L	B	H	H1
697	363	276	88



Concentrante
Concentrating

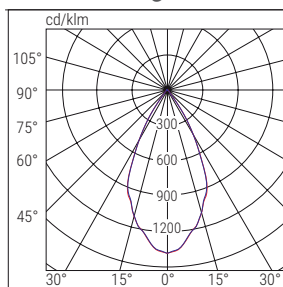

■ C90-C270 ■ C0-C180

Diffondente
Diffusing

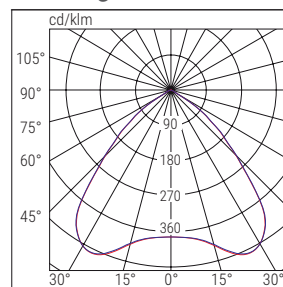

■ C90-C270 ■ C0-C180

Diffondente ampio
Wide diffusing

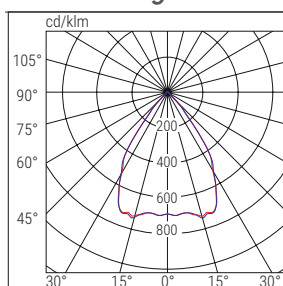

■ C90-C270 ■ C0-C180

Riflettore ellittica
Elliptical reflector

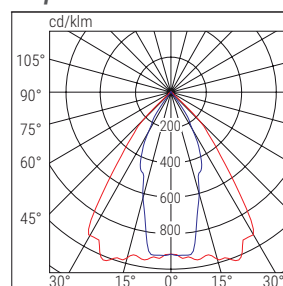

■ C90-C270 ■ C0-C180



Installazione a sospensione
Suspended mounting

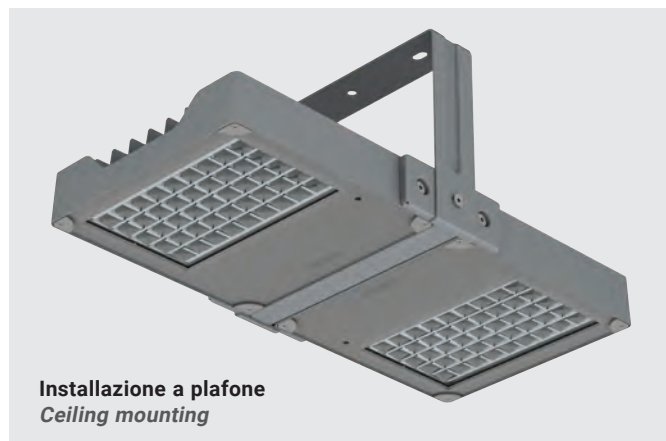

Installazione a plafone
Ceiling mounting

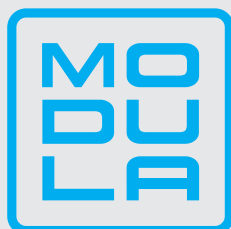

BOX DI DERIVAZIONE CON VANO MORSETTIERA
JUNCTION BOX WITH TERMINAL BLOCK

Nel retro dell'armatura stradale è presente una scatola stagna in alluminio pressofuso per contenere la morsettiera di alimentazione e controllo
On the back of luminaires there is a waterproof aluminium junction box to contain the power and control terminal block



MODULO EMERGENZA TR
EMERGENCY TR MODULE

Accessorio per integrare l'illuminazione di emergenza nell'apparecchio. Il box, in Alluminio pressofuso, contiene l'elettronica e la batteria per la versione TR.

Accessory available to integrate emergency lighting into the luminaire. The box, in die-cast aluminium, contains the electronics and battery for the TR version.



H-PRO Modula

	Cod.	Descrizione Description	Ottica Optics	Potenza Power W	Temp. colore Colour Temp. K	CRI	Flusso LED LED Flux lm (Tj=25°C)	Flusso Flux lm	Efficienza Efficiency lm/W	Kg	
RD	44001	HIGHBAY 2M RD 200 R CONC 4K	Concentrante Concentrating	200	4000	>80	37500	32550 max*	163	12	REGOLABILE
	44004	HIGHBAY 2M RD 300 R CONC 4K	Concentrante Concentrating	300	4000	>80	54400	47250 max*	158	12	
	44007	HIGHBAY 2M RD 200 R EX DIF 4K	Diffondente Ampia Wide Diffusing	200	4000	>80	37500	32550 max*	163	12	
	44010	HIGHBAY 2M RD 300 R DIF 4K	Diffondente Diffusing	300	4000	>80	54400	47250 max*	158	12	
	44013	HIGHBAY 2M RD 200 R ELL 4K	Ellittica Elliptical	200	4000	>80	37500	32550 max*	163	12	
	44016	HIGHBAY 2M RD 300 R ELL 4K	Ellittica Elliptical	300	4000	>80	54400	47250 max*	158	12	
DALI	44019	HIGHBAY 2M DALI 200 R CONC 4K	Concentrante Concentrating	200	4000	>80	39300	34100	171	12	DALI
	44022	HIGHBAY 2M DALI 300 R CONC 4K	Concentrante Concentrating	300	4000	>80	57000	49500	165	12	
	44025	HIGHBAY 2M DALI 200 R EX DIF 4K	Diffondente Ampia Wide Diffusing	200	4000	>80	39300	34100	171	12	
	44028	HIGHBAY 2M DALI 300 R DIF 4K	Diffondente Ampia Wide Diffusing	300	4000	>80	57000	49500	165	12	
	44031	HIGHBAY 2M DALI 200 R ELL 4K	Ellittica Elliptical	200	4000	>80	39300	34100	171	12	
	44034	HIGHBAY 2M DALI 300 R ELL 4K	Ellittica Elliptical	300	4000	>80	57000	49500	165	12	
SD	44037	HIGHBAY 2M SDB 200 R CONC 4K	Concentrante Concentrating	200	4000	>80	39300	34100	171	12	AUTODIMMER - BLUETOOTH
	44040	HIGHBAY 2M SDB 300 R CONC 4K	Diffondente Diffusing	300	4000	>80	57000	49500	165	12	
	44043	HIGHBAY 2M SDB 200 R EX DIF 4K	Diffondente Ampia Wide Diffusing	200	4000	>80	39300	34100	171	12	
	44046	HIGHBAY 2M SDB 300 R DIF 4K	Diffondente Diffusing	300	4000	>80	57000	49500	165	12	
	44049	HIGHBAY 2M SDB 200 R ELL 4K	Ellittica Elliptical	200	4000	>80	39300	34100	171	12	
	44052	HIGHBAY 2M SDB 300 R ELL 4K	Ellittica Elliptical	300	4000	>80	57000	49500	165	12	

* Flusso regolabile fino a 4 Step / Adjustable flux up to 4 Step

ACCESSORI - in dotazione / ACCESSORIES - included

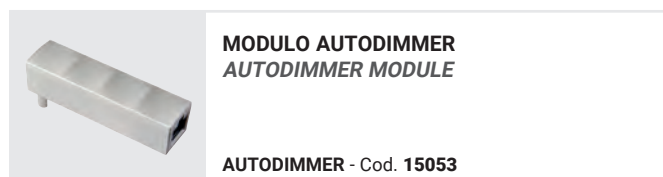

ACCESSORI - da ordinare separatamente / ACCESSORIES - to be ordered separately



GRIGLIA FLOOD MODULA M SINGOLA
FLOOD MODULA M SINGLE GRID
 H-PRO Modula necessita di 2 griglie
 H-PRO Modula needs 2 grids

Cod. **12667**



CAVI DI SOSPENSIONE
CEILING MOUNTING CABLES

Cod. **12663**

SD ACCESSORI - da ordinare separatamente / ACCESSORIES - to be ordered separately



CENTRALE LOGICA
LOGICA CONTROL UNIT

SD LGFM - Cod. **21102**



MODULI AUTODIMMER/RADIO
AUTODIMMER/RADIO MODULES

AUTODIMMER + RADIO - Cod. **15054**



CONCENTRATORE WIFI BLUETOOTH
WiFi BLUETOOTH CONCENTRATOR
 1 ingresso di controllo / 1 control input

Cod. **15064**



MODULO INTERFACCIA BLUETOOTH
BLUETOOTH MODULE INTERFACE
 3 ingressi di controllo / 3 control inputs

Cod. **15065**



CONCENTRATORE BLUETOOTH EASY BOX
BLUETOOTH EASY BOX CONCENTRATOR

WiFi - Cod. **15174**
 WiFi ETHERNET - Cod. **15074**



SENSORE PRESENZA
MOTION SENSOR

INDUSTR IP65 - Cod. **15063**
UFFICI IP40 - Cod. **15062**

Sistema di trasmissione wireless integrato che permette la comunicazione fra gli apparecchi in modo da realizzare gruppi che attuano gli stessi comandi senza aggiungere ulteriori cablaggi. Utilizzando il Modulo interfaccia Bluetooth è possibile comandare i gruppi in modalità wireless. Per gestire un impianto centralizzato da APP B.connect occorre integrare il Concentratore Bluetooth. *Integrated wireless transmission system for communication between luminaires in order to create groups with the same commands without adding further wiring. Using the Bluetooth Interface Module it is possible to control the groups wireless. To manage a centralized system from the B.connect APP, the Bluetooth concentrator must be integrated.*

EMERGENZA CON INVERTER LED - da ordinare separatamente EMERGENCY LED INVERTER - to be ordered separately



MODULO/MODULE TR - LG230 - LG24 - EPS

TR - Cod. **15069** (6W 1h)
LG24 - Cod. **15071** - versione SD / SD Version
LG230 - Cod. **15070** - versione SD / SD Version
LG EPS - Cod. **15072** - versione SD / SD Version

Versione con emergenza integrata tipo **TR** si ottiene sostituendo la Staffa di derivazione Modula con la versione opzionale **TR**.

TR emergency by replacing the Modula box bracket with the optional Modula box bracket TR version.

H-PRO



IP66

IK09

960°

+40°C
-20°C

EMERGENZA

+40°C
0°C



Caratteristiche

Mantenimento flusso luminoso a 25°C

>60.000h (240W) (L80B20)

>70.000h (150W) (L80B20)

Installazioni al suolo, parete, torri faro

Corpo Alluminio pressofuso verniciato alle polveri di poliestere, RAL 7040

Ottica Lamellare a sviluppo parabolico in alluminio anodizzato brillantato antiriflescente. Diffondente, concentrante, ellittico.

Schermo Vetro temprato prismaticizzato 4mm

Conformità EN 60598-1, EN 60598-2-1, EN 60598-2-22, DIN 18031-3, EN 62471 (rischio biologico esente), 2014/53/UE, EN60598-2-22

Applicazioni

Industriale, magazzini per logistica, hangar

Characteristics

Luminous flux retention at 25°C

>60,000h (240W) (L80B20)

>70,000h (150W) (L80B20)

Mounting Floor, wall, lighthouse towers

Housing Polyester powder-coated die-cast aluminium, RAL 7040

Optics Parabolic blades, made of anti-iridescent polished anodised aluminium. Diffusing, concentrating, elliptical.

Screen Tempered glass prism, 4mm

Compliance EN 60598-1, EN 60598-2-1, EN 60598-2-22, DIN 18031-3, EN 62471 (photobiological risk-free), 2014/53/EU

Applications

Industry, logistics warehouses, hangars

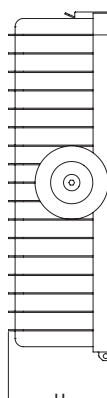
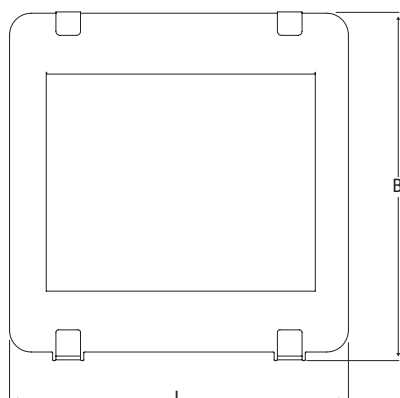

Dimensioni
Dimensions
mm

L	B	H
436	434	121

OTTICA DIFFONDEnte / DIFFUSED OPTICS

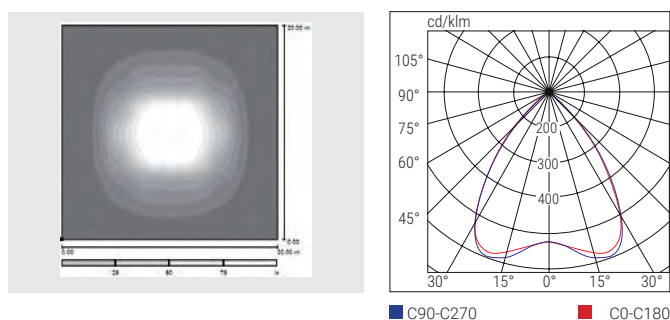

OTTICA ELLITTICA / ELLIPTICAL OPTICS

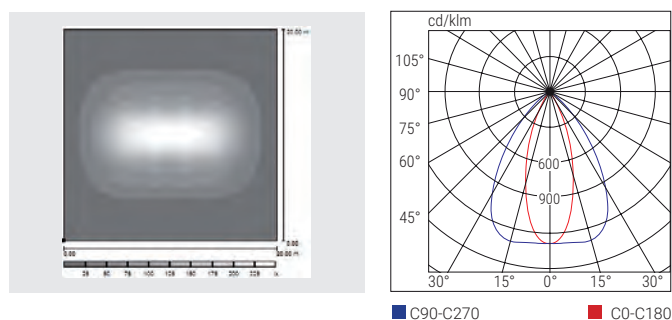

OTTICA CONCENTRANTE / CONCENTRATING OPTICS

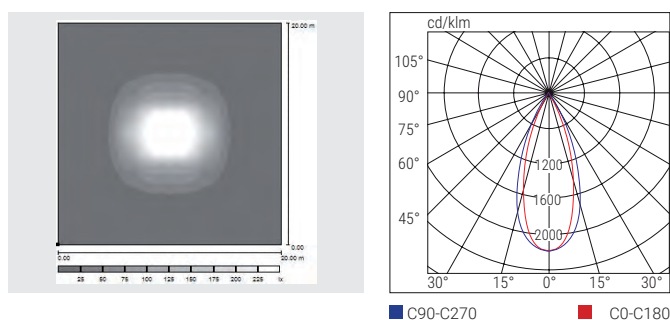

	Cod.	Descrizione Description	Optica Optics	Potenza Power W	Temp. colore Colour Temp. K	CRI	Flusso LED LED Flux lm (Tj=25°C)	Flusso Flux lm	Efficienza Efficiency lm/W	Kg	
RD	40821	RIF S 150W D REGOLABILE 010 4K	Diffondente Diffusing	153	4000	>80	27000	22824	158	7.7	REGOLABILE 0-10V
	40824	RIF S 150W C REGOLABILE 010 4K	Concentrante Concentrating	153	4000	>80	27000	21683	150	7.7	
	40827	RIF S 150W E REGOLABILE 010 4K	Ellittica Elliptical	153	4000	>80	27000	22140	154	7.7	
	40830	RIF S 240W D REGOLABILE 010 4K	Diffondente Diffusing	246	4000	>80	47000	40005	177	7.7	
	40833	RIF S 240W C REGOLABILE 010 4K	Concentrante Concentrating	246	4000	>80	47000	38005	168	7.7	
	40836	RIF S 240W E REGOLABILE 010 4K	Ellittica Elliptical	246	4000	>80	47000	38805	172	7.7	
DALI	40821DL	RIF S 150W D DALI 4K	Diffondente Diffusing	153	4000	>80	27000	22824	149	7.7	DALI
	40824DL	RIF S 150W C DALI 4K	Concentrante Concentrating	153	4000	>80	27000	21683	142	7.7	
	40827DL	RIF S 150W E DALI 4K	Ellittica Elliptical	153	4000	>80	27000	22140	145	7.7	
	40830DL	RIF S 240W D DALI 4K	Diffondente Diffusing	246	4000	>80	47000	40005	163	7.7	
	40833DL	RIF S 240W C DALI 4K	Concentrante Concentrating	246	4000	>80	47000	38005	155	7.7	
	40836DL	RIF S 240W E DALI 4K	Ellittica Elliptical	246	4000	>80	47000	38805	158	7.7	
SDB	40873	RIF S 150W D SDB 4K	Diffondente Diffusing	153	4000	>80	27000	22824	149	7.7	BLUETOOTH
	40876	RIF S 150W C SDB 4K	Concentrante Concentrating	153	4000	>80	27000	21683	142	7.7	

SEGUE / NEXT >

105 riflettori industriali / industrial high bay lights

H-PRO

	Cod.	Descrizione Description	Ottica Optics	Potenza Power W	Temp. colore Colour Temp. K	CRI	Flusso LED LED Flux lm (Tj=25°C)	Flusso Flux lm	Efficienza Efficiency lm/W	Kg
SD	40879	RIF S 150W E SDB 4K	Ellittica Elliptical	153	4000	>80	27000	22140	145	7.7
	40882	RIF S 240W D SDB 4K	Diffondente Diffusing	246	4000	>80	47000	38853	158	7.7
	40885	RIF S 240W C SDB 4K	Concentrante Concentrating	246	4000	>80	47000	38005	154	7.7
	40888	RIF S 240W E SDB 4K	Ellittica Elliptical	246	4000	>80	47000	38638	157	7.7

RD FLUSSO-POTENZA REGOLABILI / ADJUSTABLE FLUX-POWER

	Flusso /Potenza Flux/Power	150W			240W		
		lm	W	lm/W	lm	W	lm/W
STEP 1		22824	153	149	40005	246	163
STEP 2		19623	129	152	33507	200	168
STEP 3		16398	105	156	27994	162	173
STEP 4		13779	87	158	23575	133	177

Schema riferito alla sola versione DIFFONDENTE con 4 step di modulazione della corrente in modo da assicurare la massima efficienza luminosa. Per i dati relativi alle altre versioni (CONCENTRANTE ed ELLITTICA) fare riferimento al Catalogo online.
Diagram referring only to the DIFFUSING version with 4 current modulation steps to ensure maximum lighting efficiency. For data on the other versions (CONCENTRATING and ELLIPTICAL), please refer to the on-line catalogue.

VARIANTI SPECIALI - a richiesta / SPECIAL VARIANTS - on request

RESA CROMATICA ≥ 90 - TEMPERATURA COLORE A RICHIESTA - VERSIONE CON DIFFUSORE IN POLICARBONATO PER AMBIENTI HACCP (IP54)
CHROMATIC YIELD ≥ 90 - COLOUR TEMPERATURE ON REQUEST - VERSION WITH POLYCARBONATE DIFFUSER FOR HACCP ENVIRONMENTS (IP54)

ACCESSORI - in dotazione / ACCESSORIES - included

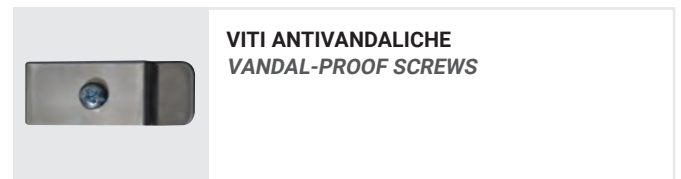

ACCESSORI - da ordinare separatamente / ACCESSORIES - to be ordered separately

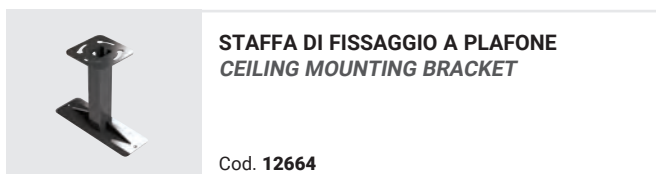
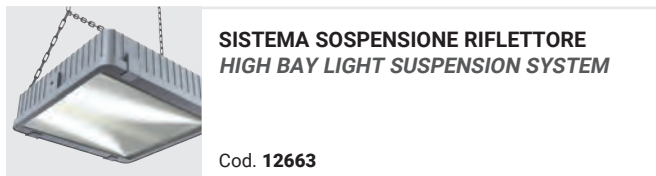

SD ACCESSORI - da ordinare separatamente / **ACCESSORIES** - to be ordered separately



**CENTRALE LOGICA
LOGICA CONTROL UNIT**

SD LGFM - Cod. **21102**



**MODULI AUTODIMMER/RADIO
AUTODIMMER/RADIO MODULES**

AUTODIMMER - Cod. **15053**
AUTODIMMER + RADIO - Cod. **15054**



**CONCENTRATORE WIFI BLUETOOTH
WIFI BLUETOOTH CONCENTRATOR**
1 ingresso di controllo / 1 control input

Cod. **15064**





**MODULO INTERFACCIA BLUETOOTH
BLUETOOTH MODULE INTERFACE**
3 ingressi di controllo / 3 control inputs

Cod. **15065**

**CONCENTRATORE BLUETOOTH EASY BOX
BLUETOOTH EASY BOX CONCENTRATOR**

WiFi - Cod. **15174**
WiFi ETHERNET - Cod. **15074**





**SENSORE PRESENZA
MOTION SENSOR**

INDUSTR IP65 - Cod. **15063**
UFFICI IP40 - Cod. **15062**

Sistema di trasmissione wireless integrato che permette la comunicazione fra gli apparecchi in modo da realizzare gruppi che attuano gli stessi comandi senza aggiungere ulteriori cablaggi. Utilizzando il Modulo interfaccia Bluetooth è possibile comandare i gruppi in modalità wireless. Per gestire un impianto centralizzato da APP B.connect occorre integrare il Concentratore Bluetooth. *Integrated wireless transmission system for communication between luminaires in order to create groups with the same commands without adding further wiring. Using the Bluetooth Interface Module it is possible to control the groups wireless. To manage a centralized system from the B.connect APP, the Bluetooth concentrator must be integrated.*

APPARECCHIO + EMERGENZA CON INVERTER LED PRECABLABATO - codifica componibile
LUMINAIRE + EMERGENCY WITH PRE-WIRED LED INVERTER - modular coding

INVERTER INTEGRATO BUILT-IN INVERTER	DESINENZA SUFFIX	SISTEMA DI EMERGENZA EMERGENCY SYSTEM	AUTONOMIA (h) AUTONOMY (h)	POTENZA LED (W) LED POWER (W)
	TR1	TR	1	3
	TR3	TR	3	3
	AT	AT	1/1.5/2/3/8	5/3.3/2.5/1.7/0.7
	CT	CT	1/1.5/2/3/8	5/3.3/2.5/1.7/0.7



MODULO / MODULE LG - LGFM - DALI
Solo per Inverter CT / For CT Inverters only

LG - Cod. **15079**
LGFM - Cod. **15037**
DALI - Cod. **15080**

LG

LGFM

DALI



BOOSTER BATTERY (AT - CT version)
1 Batteria - Raddoppia Potenza 10W e Flusso emergenza
2 Batteria - Triplice Potenza 15W e Flusso emergenza
1 Battery - Double Power 10W and emergency Flux
2 Battery - Triple Power 15W and emergency Flux

Cod. **RA13**

Ogni apparecchio di questa serie può essere **configurato e precablato direttamente in Beghelli**, già pronto per l'installazione. Per ordinarlo è necessario creare il codice specificando il sistema di controllo utilizzando come segue le presenti tabelle: **Cod. APPARECCHIO + DESINENZA**, per esempio per ordinare un proiettore H-PRO in versione CentralTest (CT) occorre aggiungere al Cod. 40821 la desinenza CT = Cod. 40821CT

*Each unit in this series can be **configured and pre-wired directly in Beghelli**, ready for installation. For orders, create the code by specifying the control system using the following tables: **Cod. LUMINAIRE + SUFFIX**, for example, to order an CentralTest (CT) H-PRO, add to the Cod. 40821 the suffix CT = Cod. 40821CT*



BS240



WEB
CATALOGUE



IP66

IK08

850°

+40°C
-20°C



Caratteristiche

Mantenimento flusso luminoso a 25°C
>70.000h (L80B20)

Installazioni Plafone, sospensione, barra elettrificata

Corpo Alluminio pressofuso verniciato alle polveri di poliestere, RAL 7040

Ottica Antiabbagliamento diffondente

Conformità EN 60598-1, EN 60598-2-1, EN 60598-2-22, DIN 18031-3, EN62471 (rischio fotobiologico esente), 2014/53/UE, EN60598-2-22

Applicazioni

Industria, terziario, palestre, parcheggi, magazzini, centri commerciali, aree soggette ad HACCP

Characteristics

Luminous flux retention at 25°C
>70,000h (L80B20)

Mounting Ceiling, suspended, electrified track

Housing Polyester powder-coated die-cast aluminium, RAL 7040

Optics Anti-glare aluminium, diffusing

Compliance EN 60598-1, EN 60598-2-1, EN 60598-2-22, DIN 18031-3, EN 62471 (photobiological risk-free), 2014/53/EU

Applications

Industry, services sector, gyms, car parks, warehouses, shopping centres, areas subject to HACCP

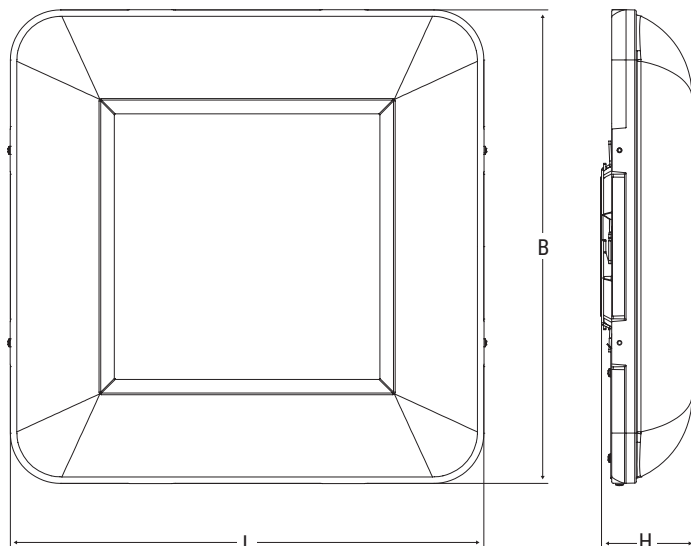

Dimensioni
Dimensions
mm

L	B	H
443	443	85

BS240

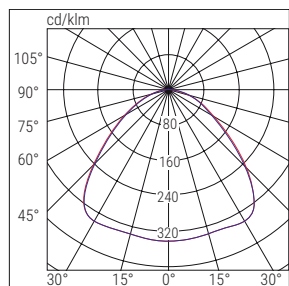

■ C0-C180 ■ C90-C270

BS240 PARKING

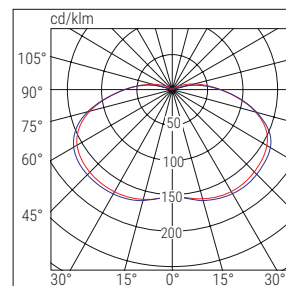

■ C0-C180 ■ C90-C270

	Cod.	Descrizione Description	Potenza Power W	Temp. colore Colour Temp. K	CRI	Flusso LED LED Flux lm (Tj=25°C)	Flusso Flux lm	Efficienza Efficiency lm/W	Kg	
RD	42377	BS240 LED 455 REG HV 4K CRI80	100÷63	4000	>80	15300	13300÷8500	135	5.5	REGOLABILE
	42378	BS240 LED 655 REG HV 4K CRI80	140÷110	4000	>80	7700	19000÷15000	131	5.5	
	42379	BS240 LED PARK REG HV 4K CRI80	52÷43	4000	>80	24500	7000÷5700	130	5	
DALI	42374	BS240 LED 455 DL 4K CRI80	100	4000	>80	15300	13300	135	5.5	DALI
	42375	BS240 LED 655 DL 4K CRI80	160	4000	>80	24500	21300	131	5.5	
	42376	BS240 LED PARKING DL 4K CRI80	50	4000	>80	7700	6650	130	5	
SD	42370	BS240 LED 455 SDB 4K CRI80	100	4000	>80	15300	13300	135	5.5	BLUETOOTH
	42371	BS240 LED 655 SDB 4K CRI80	160	4000	>80	24500	21300	131	5.5	
	42372	BS240 LED PARKING SDB 4K CRI80	50	4000	>80	7700	6650	130	5	

ACCESSORI - in dotazione / ACCESSORIES - included

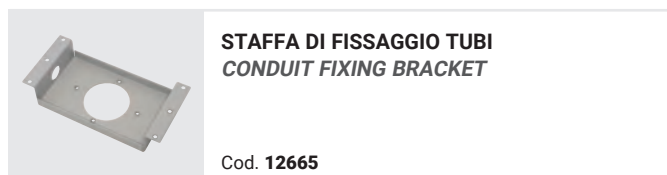
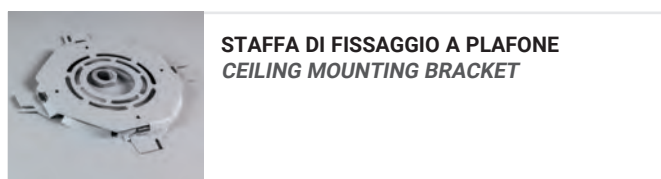
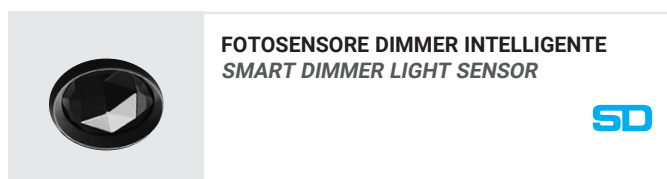



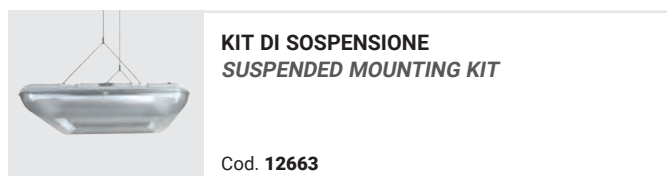





ACCESSORI - da ordinare separatamente / ACCESSORIES - to be ordered separately













BS240

SD ACCESSORI - da ordinare separatamente / ACCESSORIES - to be ordered separately

	<p>CENTRALE LOGICA <i>LOGICA CONTROL UNIT</i></p> <p>SD LGFM - Cod. 21102</p>		<p>MODULI AUTODIMMER/RADIO <i>AUTODIMMER/RADIO MODULES</i></p> <p>AUTODIMMER - Cod. 15053 AUTODIMMER + RADIO - Cod. 15054</p>
	<p>CONCENTRATORE WIFI BLUETOOTH <i>WiFi BLUETOOTH CONCENTRATOR</i> 1 ingresso di controllo / 1 control input</p> <p>Cod. 15064</p> 		<p>MODULO INTERFACCIA BLUETOOTH <i>BLUETOOTH MODULE INTERFACE</i> 3 ingressi di controllo / 3 control inputs</p> <p>Cod. 15065</p> 
	<p>CONCENTRATORE BLUETOOTH EASY BOX <i>BLUETOOTH EASY BOX CONCENTRATOR</i></p> <p>WiFi - Cod. 15174 WiFi ETHERNET - Cod. 15074</p> 		<p>SENSORE PRESENZA <i>MOTION SENSOR</i></p> <p>INDUSTR IP65 - Cod. 15063 UFFICI IP40 - Cod. 15062</p>

Sistema di trasmissione wireless integrato che permette la comunicazione fra gli apparecchi in modo da realizzare gruppi che attuano gli stessi comandi senza aggiungere ulteriori cablaggi. Utilizzando il Modulo interfaccia Bluetooth è possibile comandare i gruppi in modalità wireless. Per gestire un impianto centralizzato da APP B.connect occorre integrare il Concentratore Bluetooth. *Integrated wireless transmission system for communication between luminaires in order to create groups with the same commands without adding further wiring. Using the Bluetooth Interface Module it is possible to control the groups wireless. To manage a centralized system from the B.connect APP, the Bluetooth concentrator must be integrated.*

EMERGENZA CON INVERTER LED - da ordinare separatamente EMERGENCY LED INVERTER - to be ordered separately

	<p>INVERTER PLUG&LIGHT SE/SA 1-3h 60-180V</p> <p>Cod. 19367 (1h) Cod. 19371 (3h)</p> 		<p>BOOSTER BATTERY Batteria LiFe 6.4V 1,5Ah - Raddoppia la Potenza (10W) e il Flusso luminoso (1600lm) in emergenza <i>LiFe 6.4V 1,5Ah Battery - Double the Power (10W) and the Emergency Flux (1600lm)</i></p> <p>Cod. RA13</p>
	<p>INVERTER UNIVERSALE 5W 20-240V</p> <p>AT - Cod. 19398 CT - Cod. 19399</p>  		<p>MODULO / MODULE LG - LGFM - DALI Solo per Inverter CT / <i>For CT Inverters only</i></p> <p>LG - Cod. 15079 LGFM - Cod. 15037 DALI - Cod. 15080</p>   



111 riflettori industriali / industriali high bay lights

Highbay HP



WEB
CATALOGUE



IP65

IK09

960°

+50°C
-25°C



Caratteristiche

Mantenimento flusso luminoso a 25°C

>50.000h (L80B20)

Installazioni Sospensione, plafone, parete, suolo

Corpo Alluminio pressofuso verniciato alle polveri di poliestere RAL 7040

Ottica Lente Circolare in PMMA

Conformità EN60598-1, EN60598-2-1, EN 62471, 2014/53/UE, EN60598-2-22, DIN 18031-3, EN60598-2-22

Applicazioni

Industriale, magazzini per logistica, hangar

Characteristics

Luminous flux retention at 25°C

>50,000h (L80B20)

Mounting Suspended, ceiling, wall, floor

Housing Polyester powder-coated die-cast aluminium, RAL 7040

Optics Round PMMA Lens

Compliance EN60598-1, EN60598-2-1, EN 62471, 2014/53/EU, EN60598-2-22, DIN 18031-3

Applications

Industry, logistics warehouses, hangars

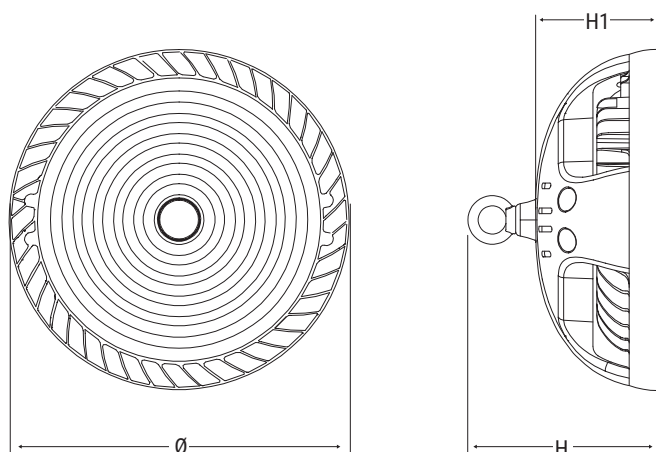

Versione Version	Cod.	Dimensioni Dimensions mm		
		H	H1	Ø
SD	40224-40225	207	148	300
	40226-40227	229	165	360
ED	40204-40205	167	108	300
	40206-40207	189	125	360

VERSIONE 240W

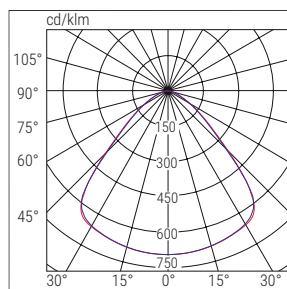

■ C0-C180 ■ C90-C270

	Cod.	Descrizione Description	Ottica Optics	Potenza Power W	Temp. colore Colour Temp. K	CRI	Flusso LED LED Flux lm (Tj=25°C)	Flusso Flux lm	Efficienza Efficiency lm/W	Kg	
ED	40204	HIGHBAY HP 100W 90°0-10V 4K ED	90°	100	4000	>80	16500	14000	140	3.9	0-10V
	40205	HIGHBAY HP 150W 90°0-10V 4K ED	90°	150	4000	>80	25000	21000	140	4.5	
	40206	HIGHBAY HP 200W 90°0-10V 4K ED	90°	200	4000	>80	33000	28000	140	7.0	
	40207	HIGHBAY HP 240W 90°0-10V 4K ED	90°	240	4000	>80	40000	34000	142	7.5	
DALI	40240	HIGHBAY HP 100W 90° DALI 4K	90°	100	4000	>80	16500	14000	140	4.2	DALI
	40241	HIGHBAY HP 150W 90° DALI 4K	90°	150	4000	>80	25000	21000	140	4.8	
	40242	HIGHBAY HP 200W 90° DALI 4K	90°	200	4000	>80	33000	28000	140	7.4	
	40243	HIGHBAY HP 240W 90° DALI 4K	90°	240	4000	>80	40000	34000	142	7.9	
SD	40224	HIGHBAY HP 100W 90° 4K SD	90°	100	4000	≥80	16500	14000	140	3.9	AUTODIMMER
	40225	HIGHBAY HP 150W 90° 4K SD	90°	150	4000	≥80	25000	21000	140	4.5	
	40226	HIGHBAY HP 200W 90° 4K SD	90°	200	4000	≥80	33000	28000	140	7.0	
	40227	HIGHBAY HP 240W 90° 4K SD	90°	240	4000	≥80	40000	34000	142	7.5	

ACCESSORI - in dotazione / ACCESSORIES - included



SENSORE AUTODIMMER CON STAFFA DI SOSTEGNO
AUTODIMMER LIGHT SENSOR WITH SUPPORT BRACKET



ACCESSORI - da ordinare separatamente / ACCESSORIES - to be ordered separately



DIFFUSORE VETRO HP 120°
GLASS DIFFUSER HP 120°

Cod. **40900** (100/150W)
 Cod. **40901** (200/240W)



CAMPANA 70° HP
BELL 70° HP

Cod. **40904** (100/150W)
 Cod. **40905** (200/240W)



DIFFUSORE HP 120° 100/150W
DIFFUSER HP 120° 100/150W

Cod. **40902** (100/150W)
 Cod. **40903** (200/240W)



CAMPANA 90° HP
BELL 90° HP

Cod. **40906** (100/150W)
 Cod. **40907** (200/240W)



STAFFA ORIENTABILE HP
SWIVEL BRACKET HP

Cod. **40908** (100/150W)
 Cod. **40909** (200/240W)

SD RADIO ACCESSORI - da ordinare separatamente / ACCESSORIES - to be ordered separately



CENTRALE LOGICA
LOGICA CONTROL UNIT

SD LGFM - Cod. 21102



MODULO RADIO DOMOTICO ESTERNO
EXTERNAL HOME AUTOMATION RADIO MODULE

TRASMETTITORE / TRANSMITTER - Cod. 20104

Highbay Multipower



IP65

IK08

∧ 950°

+40°C
-20°C

MULTIPOWER

Caratteristiche

Mantenimento flusso luminoso a 25°C

>30.000h (L70B50)

Installazioni Soffitto, parete

Corpo Alluminio pressofuso

Ottica Alluminio bianco. Simmetrica

Schermo Vetro temperato

Conformità EN60598-1, EN60598-2-1, EN 62471

Applicazioni

Industriale, magazzini, hangar

Characteristics

Luminous flux retention at 25°C

>30.000h (L70B50)

Mounting Ceiling, wall

Housing Die-cast aluminium

Optics Symmetric Withe Aluminium.

Compliance EN60598-1, EN60598-2-1, EN 62471

Applications

Industry, logistics warehouses, hangars

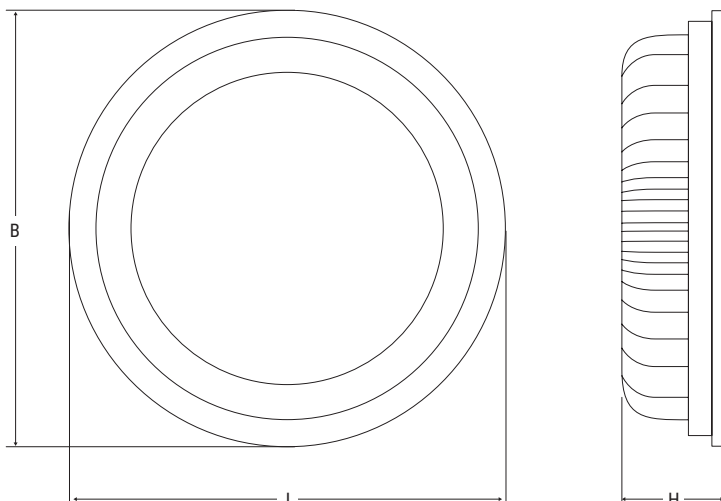

Dimensioni
Dimensioni
mm

L	B	H
299	299	60

HIGHBAY MULTIPOWER

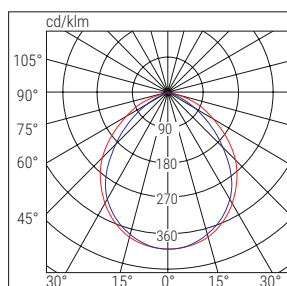

■ C0-C180 ■ C90-C270



LA VERSATILITÀ DI HIGHBAY MULTIPOWER

Riflettore industriale di ultima generazione, dotato di alimentatore a potenza variabile comandabile da uno switch protetto da un coperchio a vite che garantisce il mantenimento del grado di protezione IP65.

HIGHBAY MULTIPOWER VERSATILITY

Latest generation industrial reflector are adjustable and power controlled by a switch protected by a screw cover protection degree IP65.



Cod.	Descrizione Description	Ottica Optics	Potenza Power W	Temp. colore Colour Temp. K	CRI	Flusso LED LED Flux lm (Tj=25°C)	Flusso Flux lm	Efficienza Efficiency lm/W	Kg
RD 76305	HIGHBAY M.POWER 100/150/200W	Diffondente	200	4000	>80	22000	20000	100	4

REGOLABILE

RD FLUSSO-POTENZA REGOLABILI / ADJUSTABLE FLUX-POWER

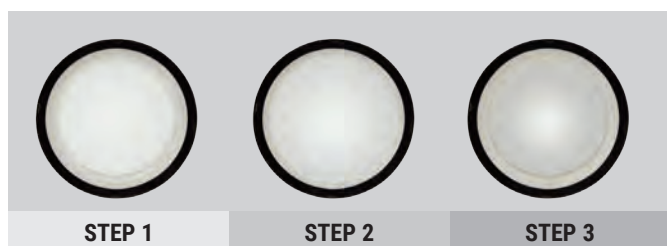

Flusso/Potenza	Highbay Multipower		
	lm	W	lm/W
STEP 1	20.000	200	100
STEP 2	15.000	150	100
STEP 3	10.000	100	100

Driver RD dotato di switch con 4 step di modulazione della corrente in modo da assicurare la massima efficienza luminosa, e quindi il massimo risparmio energetico, utilizzando solo il flusso luminoso determinato in fase di progettazione / RD driver equipped with a switch with 4 steps of current modulation in order to ensure maximum luminous efficiency, and therefore maximum energy saving, using only the luminous flux determined in the design phase.

ACCESSORI - in dotazione ACCESSORIES - included



CAVO CABLATO / WIRED CABLE (1m)
GANCIO DI SOSPENSIONE / SUSPENSION
HOOK
STAFFA ORIENTABILE / ADJUSTABLE
BRACKET

ACCESSORI - da ordinare separatamente ACCESSORIES - to be ordered separately



CAMPANA CONCENTRANTE 80°
CONCENTRATING BELL 80°
Quick junction. Anti-iridescent aluminium

Cod. 40910

Flood MODULA - S



PROTEZIONE DA SOVRATENSIONI
OVERVOLTAGES PROTECTION
Solo Riflettori / Reflectors only **10kV**

IP66

IK08

960°

+40°C
-20°C

RIFLETTORI
REFLECTOR

+45°C
-20°C



Caratteristiche

Mantenimento flusso luminoso a 25°C
>70.000h (L80B20)

Installazioni Suolo o parete

Corpo Alluminio pressofuso RAL 7040

Ottica Lenti PMMA / riflettori Alluminio
brillantato antiiridescente

Schermo Vetro temprato

Conformità **Conformità** EN 60598-1, EN
60598-2-1, EN 60598-2-22, DIN 18031-
3, EN 62471 (Rischio biologico esente),
EN61493, 2014/53/UE, EN60598-2-22

Applicazioni

Industriale (riflettori/proiettori), terziario,
ospedali, hotel, scuole, palestre, campi
sportivi

Characteristics

Luminous flux retention at 25°C
>70.000h (L80B20)

Mounting Floor, wall

Housing Diecast Aluminium RAL 7040

Optics PMMA Lens / Anti-iridescent
polished aluminium reflector

Screen Tempered glass

Compliance EN 60598-1, EN 60598-2-1,
EN 60598-2-22, DIN 18031-3, EN 62471
(Rischio biologico esente), EN61493,
2014/53/UE, EN60598-2-22

Applications

Industry (High bay-Floodlights, services
sector, hospital, hotel, gyms, school,
sports field)

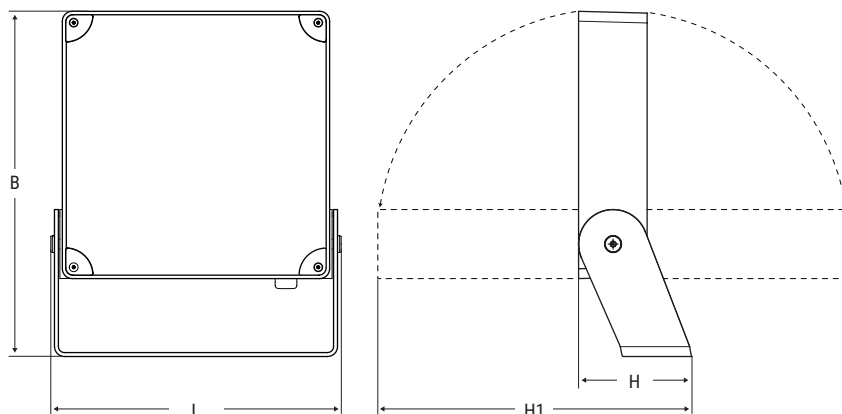

Dimensioni
Dimensions
mm

L	B	H	H1
295	350	115	316

LENTE ASIMMETRICO / ASYMMETRIC LENS

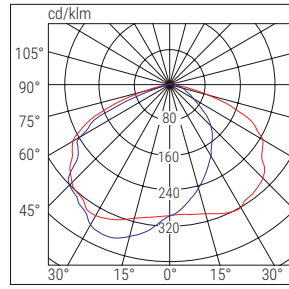

■ C90-C270 ■ C0-C180

LENTE ASIMMETRICA SPORT / ASYMMETRIC SPORT LENS

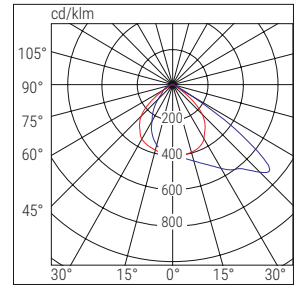

■ C90-C270 ■ C0-C180

**LENTE SIMMETRICO CONCENTRANTE
SYMMETRIC CONCENTRATING LENS**

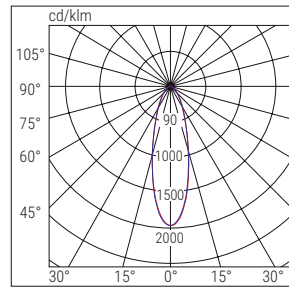

■ C90-C270 ■ C0-C180

**LENTE SIMMETRICO DIFFONDENTE
SYMMETRIC DIFFUSING LENS**

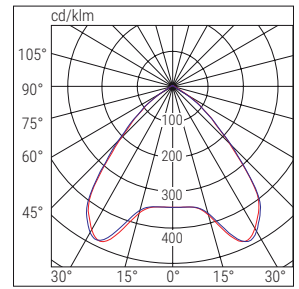

■ C90-C270 ■ C0-C180

**RIFLETTORE SIMMETRICO CONCENTRANTE
SYMMETRIC CONCENTRATING REFLECTOR**

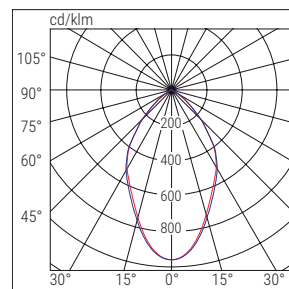

■ C90-C270 ■ C0-C180

**RIFLETTORE SIMMETRICO DIFFONDENTE
SYMMETRIC DIFFUSING REFLECTOR**

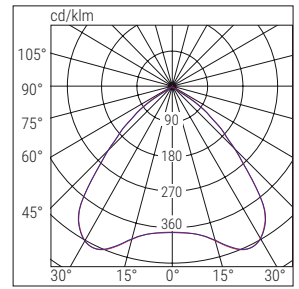

■ C90-C270 ■ C0-C180

RIFLETTORE ASIMMETRICO/ASYMMETRIC REFLECTOR

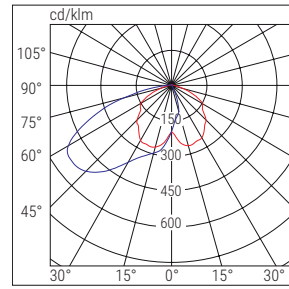

■ C90-C270 ■ C0-C180

Flood MODULA - S

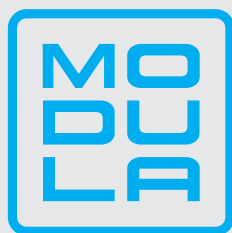

BOX DI DERVAZIONE CON VANO MORSETTIERA JUNCTION BOX WITH TERMINAL BLOCK

Nel retro dell'armatura stradale è presente una scatola stagna in alluminio pressofuso per contenere la morsettiere di alimentazione e controllo
On the back of luminaires there is a waterproof aluminium junction box to contain the power and control terminal block



MODULO EMERGENZA TR EMERGENCY TR MODULE

Accessorio per integrare l'illuminazione di emergenza nell'apparecchio. Il box, in Alluminio pressofuso, contiene l'elettronica e la batteria per la versione TR.

Accessory available to integrate emergency lighting into the luminaire. The box, in die-cast aluminium, contains the electronics and battery for the TR version.



Cod.	Descrizione Description	Ottica Optics	Potenza Power W	Temp. colore Colour Temp. K	CRI	Flusso LED LED Flux lm (Tj=25°C)	Flusso Flux lm	Efficienza Efficiency lm/W	Kg
43175	FLOOD S RD 80 L AS 4K	Lente asimmetrico Asymmetric lens	80÷75	4000	>80	14300	12432÷11813*	158	4.5
43178	FLOOD S RD 125 L AS 4K	Lente asimmetrico Asymmetric lens	125÷74	4000	>80	18900	16399÷9203*	167	4.5
43184	FLOOD S RD 80 L SPORT 4K	Lente asimmetrico Sport Asymmetric Sport lens	80÷75	4000	>80	14300	12432÷11813*	158	4.5
43187	FLOOD S RD 125 L SPORT 4K	Lente asimmetrico Sport Asymmetric Sport lens	125÷104	4000	>80	20700	17981÷15457*	149	4.5
43193	FLOOD S RD 80 L CONC 4K	Lente simmetrico concentrante Symmetrical concentrating lens	80÷75	4000	>80	14300	12432÷11813*	158	4.5
43196	FLOOD S RD 125 L CONC 4K	Lente simmetrico concentrante Symmetrical concentrating lens	125÷104	4000	>80	20700	17981÷15313*	147	4.5
43202	FLOOD S RD 80 L DIF 4K	Lente simmetrico diffondente Symmetrical diffusing lens	80÷75	4000	>80	14300	12432÷11813*	158	4.5
43205	FLOOD S RD 125 L DIF 4K	Lente simmetrico diffondente Symmetrical diffusing lens	125÷104	4000	>80	20700	17981÷15482*	147	4.5
43211	FLOOD S RD 80 R AS 4K	Riflettore asimmetrico Asymmetric reflector	80÷58	4000	>80	15400	13356÷10508*	181	4.5
43214	FLOOD S RD 100 R AS 4K	Riflettore asimmetrico Asymmetric reflector	100÷59	4000	>80	20200	17563÷9915*	180	4.5
43217	FLOOD S RD 120 R AS 4K	Riflettore asimmetrico Asymmetric reflector	120÷113	4000	>80	20600	17892÷17364*	154	4.5
43223	FLOOD S RD 80 R CONC 4K	Riflettore simmetrico concentrante Symmetrical concentrating reflector	80÷75	4000	>80	15400	13356÷12600*	168	4.5
43226	FLOOD S RD 125 R CONC 4K	Riflettore simmetrico concentrante Symmetrical concentrating reflector	125÷63	4000	>80	21500	18638÷11156*	179	4.5
43232	FLOOD S RD 80 R DIF 4K	Riflettore simmetrico diffondente Symmetrical diffusing reflector	80÷75	4000	>80	15400	13356÷12600*	168	4.5
43235	FLOOD S RD 125 R DIF 4K	Riflettore simmetrico diffondente Symmetrical diffusing reflector	125÷74	4000	>80	16200	14021÷9025*	163	4.5

* Flusso regolabile fino a 4 Step / Adjustable flux up to 4 Step

Cod.	Descrizione Description	Ottica Optics	Potenza Power W	Temp. colore Colour Temp. K	CRI	Flusso LED LED Flux lm (Tj=25°C)	Flusso Flux lm	Efficienza Efficiency lm/W	Kg
43241	FLOOD S DALI 95 L AS 4K	Lente asimmetrico Asymmetric lens	95	4000	>80	18100	14630	154	4.5
43244	FLOOD S DALI 125 L AS 4K	Lente asimmetrico Asymmetric lens	125	4000	>80	22500	18838	151	4.5
43250	FLOOD S DALI 95 L SPORT 4K	Lente asimmetrico Sport Asymmetric Sport Lens	95	4000	>80	18100	14630	154	4.5
43253	FLOOD S DALI 125 L SPORT 4K	Lente asimmetrico Sport Asymmetric Sport Lens	125	4000	>80	22500	18838	151	4.5
43259	FLOOD S DALI 95 L CONC 4K	Lente simmetrico concentrante Symmetrical concentrating lens	95	4000	>80	18100	14630	154	4.5
43262	FLOOD S DALI 125 L CONC 4K	Lente simmetrico concentrante Symmetrical concentrating lens	125	4000	>80	22500	18838	151	4.5
43268	FLOOD S DALI 95 L DIF 4K	Lente simmetrico diffondente Symmetrical diffusing lens	95	4000	>80	18100	14630	154	4.5
43271	FLOOD S DALI 125 L DIF 4K	Lente simmetrico diffondente Symmetrical diffusing lens	125	4000	>80	22500	18838	151	4.5
43277	FLOOD S DALI 80 R AS 4K	Riflettore asimmetrico Asymmetric reflector	80	4000	>80	16100	13992	175	4.5
43280	FLOOD S DALI 100 R AS 4K	Riflettore asimmetrico Asymmetric reflector	100	4000	>80	18600	16170	162	4.5
43283	FLOOD S DALI 120 R AS 4K	Riflettore asimmetrico Asymmetric reflector	120	4000	>80	21600	18744	156	4.5
43289	FLOOD S DALI 95 R CONC 4K	Riflettore simmetrico concentrante Symmetrical concentrating reflector	95	4000	>80	18100	15675	165	4.5
43292	FLOOD S DALI 125 R CONC 4K	Riflettore simmetrico concentrante Symmetrical concentrating reflector	125	4000	>80	22500	19525	156	4.5
43298	FLOOD S DALI 95 R DIF 4K	Riflettore simmetrico diffondente Symmetrical diffusing reflector	95	4000	>80	18100	15675	165	4.5
43301	FLOOD S DALI 125 R DIF 4K	Riflettore simmetrico diffondente Symmetrical diffusing reflector	125	4000	>80	22500	19525	156	4.5
43307	FLOOD S SDB 95 L AS 4K	Lente asimmetrico Asymmetric lens	95	4000	>80	18100	14630	154	4.5
43310	FLOOD S SDB 125 L AS 4K	Lente asimmetrico Asymmetric lens	125	4000	>80	22500	18838	151	4.5
43316	FLOOD S SDB 95 L SPORT 4K	Lente asimmetrico Sport Asymmetric Sport Lens	95	4000	>80	18100	14630	154	4.5
43319	FLOOD S SDB 125 L SPORT 4K	Lente asimmetrico Sport Asymmetric Sport Lens	125	4000	>80	22500	18838	151	4.5
43325	FLOOD S SDB 95 L CONC 4K	Lente simmetrico concentrante Symmetrical concentrating lens	95	4000	>80	18100	14630	154	4.5
43328	FLOOD S SDB 125 L CONC 4K	Lente simmetrico concentrante Symmetrical concentrating lens	125	4000	>80	22500	18838	151	4.5
43334	FLOOD S SDB 95 L DIF 4K	Lente simmetrico diffondente Symmetrical diffusing lens	95	4000	>80	18100	14630	154	4.5
43337	FLOOD S SDB 125 L DIF 4K	Lente simmetrico diffondente Symmetrical diffusing lens	125	4000	>80	22500	18838	151	4.5
43343	FLOOD S SDB 80 R AS 4K	Riflettore asimmetrico Asymmetric reflector	80	4000	>80	16100	13992	175	4.5
43346	FLOOD S SDB 100 R AS 4K	Riflettore asimmetrico Asymmetric reflector	100	4000	>80	18600	16170	162	4.5
43349	FLOOD S SDB 120 R AS 4K	Riflettore asimmetrico Asymmetric reflector	120	4000	>80	21600	18744	156	4.5
43355	FLOOD S SDB 95 R CONC 4K	Riflettore simmetrico concentrante Symmetrical concentrating reflector	95	4000	>80	18100	15675	165	4.5
43358	FLOOD S SDB 125 R CONC 4K	Riflettore simmetrico concentrante Symmetrical concentrating reflector	125	4000	>80	22500	19525	156	4.5
43364	FLOOD S SDB 95 R DIF 4K	Riflettore simmetrico diffondente Symmetrical diffusing reflector	95	4000	>80	18100	15675	165	4.5
43367	FLOOD S SDB 125 R DIF 4K	Riflettore simmetrico diffondente Symmetrical diffusing reflector	125	4000	>80	22500	19525	156	4.5

VARIANTI CON DIVERSA TEMPERATURA COLORE (K) / VERSIONS WITH DIFFERENT COLOUR TEMPERATURES (K)

Gli apparecchi sono disponibili anche in versione **3000K e 6000K**. L'elenco dei codici relativi è visionabile nell'**Indice analitico**, in calce ai codici su indicati con 4000K
The luminaires are also available in **3000K and 6000K** versions. A list of the related codes can be found in the **Analytical Index**, under the above codes with 4000K

Flood MODULA - S

ACCESSORI - da ordinare separatamente / ACCESSORIES - to be ordered separately



GRIGLIA FLOOD MODULA S
FLOOD MODULA S GRID

Cod. **12668**



KIT SOSPENSIONE RIFLETTORE
LIGHT SUSPENSION KIT

CAVI SOSPENSIONE / CABLES - Cod. **12663**
GOLFARI / EYEBOLT - Cod. **12669**

SD ACCESSORI - da ordinare separatamente / ACCESSORIES - to be ordered separately



CENTRALE LOGICA
LOGICA CONTROL UNIT

SD LGFM - Cod. **21102**



MODULI AUTODIMMER/RADIO
AUTODIMMER/RADIO MODULES

AUTODIMMER - Cod. **15053**
AUTODIMMER + RADIO - Cod. **15054**



CONCENTRATORE WIFI BLUETOOTH
WiFi BLUETOOTH CONCENTRATOR
1 ingresso di controllo / 1 control input

Cod. **15064**



MODULO INTERFACCIA BLUETOOTH
BLUETOOTH MODULE INTERFACE
3 ingressi di controllo / 3 control inputs

Cod. **15065**



CONCENTRATORE BLUETOOTH EASY BOX
BLUETOOTH EASY BOX CONCENTRATOR

WiFi - Cod. **15174**
WiFi ETHERNET - Cod. **15074**



SENSORE PRESENZA
MOTION SENSOR

INDUSTR IP65 - Cod. **15063**
UFFICI IP40 - Cod. **15062**

Sistema di trasmissione wireless integrato che permette la comunicazione fra gli apparecchi in modo da realizzare gruppi che attuano gli stessi comandi senza aggiungere ulteriori cablaggi. Utilizzando il Modulo interfaccia Bluetooth è possibile comandare i gruppi in modalità wireless. Per gestire un impianto centralizzato da APP B.connect occorre integrare il Concentratore Bluetooth. *Integrated wireless transmission system for communication between luminaires in order to create groups with the same commands without adding further wiring. Using the Bluetooth Interface Module it is possible to control the groups wireless. To manage a centralized system from the B.connect APP, the Bluetooth concentrator must be integrated.*

EMERGENZA CON INVERTER LED - da ordinare separatamente EMERGENCY LED INVERTER - to be ordered separately



MODULO/MODULE TR - LG230 - LG24 - EPS

TR - Cod. **15069** (6W 1h)
LG24 - Cod. **15071** - versione SD / SD Version
LG230 - Cod. **15070** - versione SD / SD Version
LG EPS - Cod. **15072** - versione SD / SD Version

Versione con emergenza integrata tipo **TR** si ottiene sostituendo la Staffa di derivazione Modula con la versione opzionale **TR**.

TR emergency by replacing the Modula box bracket with the optional Modula box bracket TR version.



121 proiettori da esterno / outdoor floodlights

Flood MODULA - M



PROTEZIONE DA SOVRATENSIONI
OVERVOLTAGES PROTECTION
Solo Riflettori / Reflectors only

10kV

IP66

IK08



LENTI / LENS

RIFLETTORI
REFLECTOR



Caratteristiche

Mantenimento flusso luminoso a 25°C
>70.000h (L80B20)

Installazioni Suolo o parete

Corpo Alluminio pressofuso RAL 7040

Ottica Lenti PMMA / riflettori Alluminio
brillantato antiiridescente

Schermo Vetro temprato

Conformità EN 60598-1, EN 60598-2-1,
EN 60598-2-22, DIN 18031-3, EN 62471
(Rischio biologico esente), EN61493,
2014/53/UE, EN60598-2-22

Applicazioni

Industriale (riflettori/proiettori), terziario,
ospedali, hotel, scuole, palestre, campi
sportivi

Characteristics

Luminous flux retention at 25°C
>70.000h (L80B20)

Mounting Floor, wall

Housing Diecast Alluminium RAL 7040

Optics PMMA Lens / Anti-iridescent
polished aluminium reflector

Screen Tempered glass

Compliance EN 60598-1, EN 60598-2-1,
EN 60598-2-22, DIN 18031-3, EN 62471
(Rischio biologico esente), EN61493,
2014/53/UE, EN60598-2-22

Applications

Industry (High bay-Floodlights, services
sector, hospital, hotel, gyms, school,
sports field)

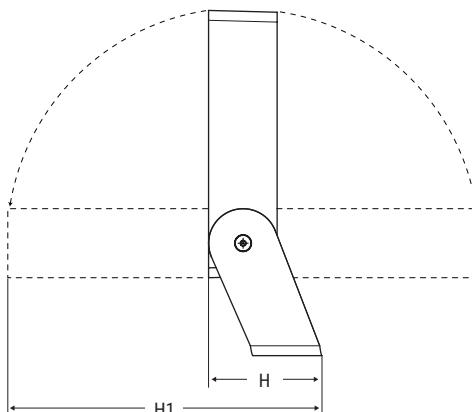
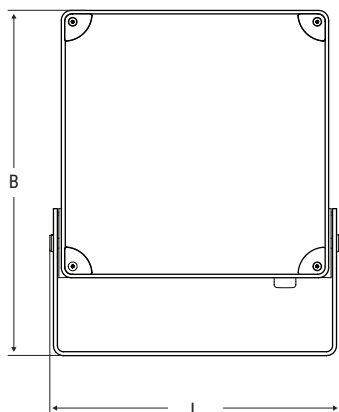

Dimensioni
Dimensions
mm

L	B	H	H1
354	409	115	375

LENTE ASIMMETRICO / ASYMMETRIC LENS

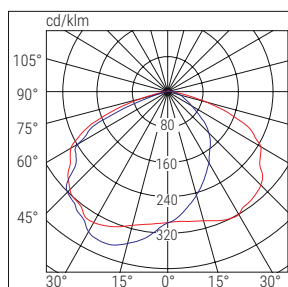

■ C90-C270 ■ C0-C180

LENTE ASIMMETRICA SPORT / ASYMMETRIC SPORT LENS

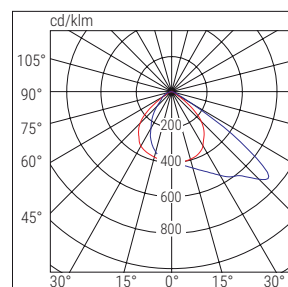

■ C90-C270 ■ C0-C180

**LENTE SIMMETRICO CONCENTRANTE
SYMMETRIC CONCENTRATING LENS**

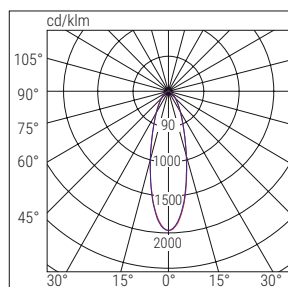

■ C90-C270 ■ C0-C180

**LENTE SIMMETRICO DIFFONDENTE
SYMMETRIC DIFFUSING LENS**

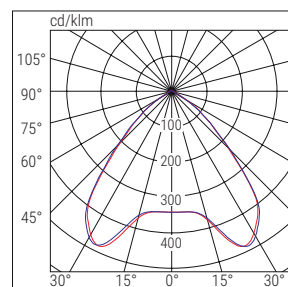

■ C90-C270 ■ C0-C180

**RIFLETTORE SIMMETRICO CONCENTRANTE
SYMMETRIC CONCENTRATING REFLECTOR**

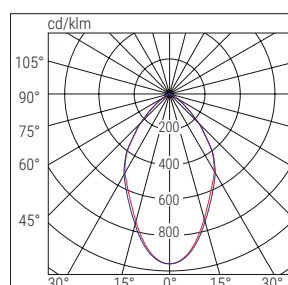

■ C90-C270 ■ C0-C180

**RIFLETTORE SIMMETRICO DIFFONDENTE
SYMMETRIC DIFFUSING REFLECTOR**

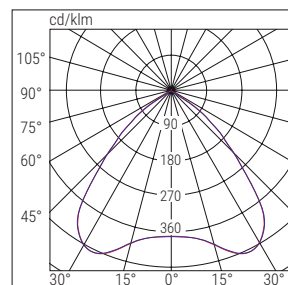

■ C90-C270 ■ C0-C180

RIFLETTORE ASIMMETRICO/ASYMMETRIC REFLECTOR

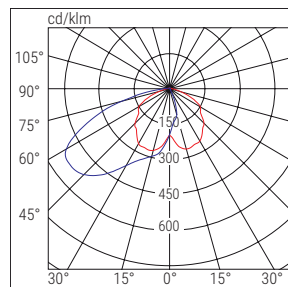

■ C90-C270 ■ C0-C180

Flood MODULA - M

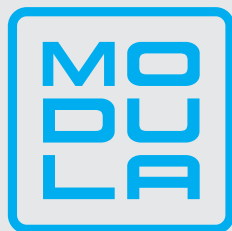

BOX DI DERVAZIONE CON VANO MORSETTIERA JUNCTION BOX WITH TERMINAL BLOCK

Nel retro dell'armatura stradale è presente una scatola stagna in alluminio pressofuso per contenere la morsettiere di alimentazione e controllo
On the back of luminaires there is a waterproof aluminium junction box to contain the power and control terminal block



MODULO EMERGENZA TR EMERGENCY TR MODULE

Accessorio per integrare l'illuminazione di emergenza nell'apparecchio. Il box, in Alluminio pressofuso, contiene l'elettronica e la batteria per la versione TR.

Accessory available to integrate emergency lighting into the luminaire. The box, in die-cast aluminium, contains the electronics and battery for the TR version.



	Cod.	Descrizione Description	Ottica Optics	Potenza Power W	Temp. colore Colour Temp. K	CRI	Flusso LED LED Flux lm (Tj=25°C)	Flusso Flux lm	Efficienza Efficiency lm/W	Kg
RD	43001	FLOOD M RD 150 L AS 4K	Lente asimmetrico Asymmetric lens	150÷140	4000	>80	27500	22995÷21903	156	5.9
	43004	FLOOD M RD 230 L AS 4K	Lente asimmetrico Asymmetric lens	210÷142	4000	>80	32700	30521÷22217	156	5.9
	43007	FLOOD M RD 150 L SPORT 4K	Lente asimmetrico Sport Asymmetric Sport lens	150÷65	4000	>80	37800	21845÷10306	163	5.9
	43010	FLOOD M RD 230 L SPORT 4K	Lente asimmetrico Sport Asymmetric Sport lens	210÷142	4000	>80	28500	30429÷22217	156	5.9
	43013	FLOOD M RD 150 L CONC 4K	Lente simmetrico concentrante Symmetrical concentrating lens	150÷140	4000	>80	37600	22995÷21903	156	5.9
	43016	FLOOD M RD 230 L CONC 4K	Lente simmetrico concentrante Symmetrical concentrating lens	210÷142	4000	>80	28500	30429÷22217	156	5.9
	43019	FLOOD M RD 150 L DIF 4K	Lente simmetrico diffondente Symmetrical diffusing lens	150÷65	4000	>80	37600	21845÷10306	163	5.9
	43022	FLOOD M RD 230 L DIF 4K	Lente simmetrico diffondente Symmetrical diffusing lens	210÷142	4000	>80	26500	30429÷22217	156	5.9
	43025	FLOOD M RD 145 R AS 4K	Riflettore asimmetrico Asymmetric reflector	145÷89	4000	>80	35100	23903÷15178	170	5.9
	43028	FLOOD M RD 180 R AS 4K	Riflettore asimmetrico Asymmetric reflector	180÷135	4000	>80	32600	28350÷21250	158	5.9
	43031	FLOOD M RD 225 R AS 4K	Riflettore asimmetrico Asymmetric reflector	210÷158	4000	>80	35000	32855÷25964	165	5.9
	43034	FLOOD M RD 150 R CONC 4K	Riflettore simmetrico concentrante Symmetrical concentrating reflector	150÷93	4000	>80	26500	24728÷15876	170	5.9
	43037	FLOOD M RD 230 R CONC 4K	Riflettore simmetrico concentrante Symmetrical concentrating reflector	210÷142	4000	>80	35000	32634÷23856	168	5.9
	43040	FLOOD M RD 150 R DIF 4K	Riflettore simmetrico diffondente Symmetrical diffusing reflector	150÷75	4000	>80	25200	24728÷12758	170	5.9
	43043	FLOOD M RD 230 R DIF 4K	Riflettore simmetrico diffondente Symmetrical diffusing reflector	210÷142	4000	>80	35000	32634÷23856	168	5.9
DALI	43046	FLOOD M DALI 145 L AS 4K	Lente asimmetrico Asymmetric lens	145	4000	>80	28800	24723	171	5.9
	43049	FLOOD M DALI 190 L AS 4K	Lente asimmetrico Asymmetric lens	190	4000	>80	36100	29260	154	5.9
	43052	FLOOD M DALI 230 L AS 4K	Lente asimmetrico Asymmetric lens	230	4000	>80	43100	34914	152	5.9
	43055	FLOOD M DALI 145 L SPORT 4K	Lente asimmetrico Sport Asymmetric Sport lens	145	4000	>80	28800	24723	171	5.9
	43058	FLOOD M DALI 190 L SPORT 4K	Lente asimmetrico Sport Asymmetric Sport lens	190	4000	>80	36100	29260	154	5.9
	43061	FLOOD M DALI 230 L SPORT 4K	Lente asimmetrico Sport Asymmetric Sport lens	230	4000	>80	43100	34914	152	5.9
	43064	FLOOD M DALI 145 L CONC 4K	Lente simmetrico concentrante Symmetrical concentrating lens	145	4000	>80	28800	24723	171	5.9
	43067	FLOOD M DALI 190 L CONC 4K	Lente simmetrico concentrante Symmetrical concentrating lens	190	4000	>80	36100	29260	154	5.9

* Flusso regolabile fino a 4 Step / Adjustable flux up to 4 Step

Cod.	Descrizione Description	Ottica Optics	Potenza Power W	Temp. colore Colour Temp. K	CRI	Flusso LED LED Flux lm (Tj=25°C)	Flusso Flux lm	Efficienza Efficiency lm/W	Kg
43070	FLOOD M DALI 230 L CONC 4K	Lente simmetrico concentrante <i>Symmetrical concentrating lens</i>	230	4000	>80	43100	34914	152	5.9
43073	FLOOD M DALI 145 L DIF 4K	Lente simmetrico diffondente <i>Symmetrical diffusing lens</i>	145	4000	>80	28800	24723	171	5.9
43076	FLOOD M DALI 190 L DIF 4K	Lente simmetrico diffondente <i>Symmetrical diffusing lens</i>	190	4000	>80	36100	29260	154	5.9
43079	FLOOD M DALI 230 L DIF 4K	Lente simmetrico diffondente <i>Symmetrical diffusing lens</i>	230	4000	>80	43100	34914	152	5.9
43082	FLOOD M DALI 145 R AS 4K	Riflettore asimmetrico <i>Asymmetric reflector</i>	145	4000	>80	28800	25042	173	5.9
43085	FLOOD M DALI 180 R AS 4K	Riflettore asimmetrico <i>Asymmetric reflector</i>	180	4000	>80	34200	29700	165	5.9
43088	FLOOD M DALI 230 R AS 4K	Riflettore asimmetrico <i>Asymmetric reflector</i>	225	4000	>80	43400	37697	164	5.9
43091	FLOOD M DALI 145 R CONC 4K	Riflettore simmetrico concentrante <i>Symmetrical concentrating reflector</i>	145	4000	>80	28800	25042	173	5.9
43094	FLOOD M DALI 190 R CONC 4K	Riflettore simmetrico concentrante <i>Symmetrical concentrating reflector</i>	190	4000	>80	36100	31350	165	5.9
43097	FLOOD M DALI 230 R CONC 4K	Riflettore simmetrico concentrante <i>Symmetrical concentrating reflector</i>	230	4000	>80	43100	37444	163	5.9
43100	FLOOD M DALI 145 R DIF 4K	Riflettore simmetrico diffondente <i>Symmetrical diffusing reflector</i>	145	4000	>80	28800	25042	173	5.9
43103	FLOOD M DALI 190 R DIF 4K	Riflettore simmetrico diffondente <i>Symmetrical diffusing reflector</i>	190	4000	>80	36100	31350	165	5.9
43106	FLOOD M DALI 230 R DIF 4K	Riflettore simmetrico diffondente <i>Symmetrical diffusing reflector</i>	230	4000	>80	43100	37444	163	5.9
43109	FLOOD M SDB 145 L AS 4K	Lente asimmetrico <i>Asymmetric lens</i>	145	4000	>80	28800	24723	171	5.9
43112	FLOOD M SDB 190 L AS 4K	Lente asimmetrico <i>Asymmetric lens</i>	190	4000	>80	36100	29260	154	5.9
43115	FLOOD M SDB 230 L AS 4K	Lente asimmetrico <i>Asymmetric lens</i>	230	4000	>80	43100	34914	152	5.9
43118	FLOOD M SDB 145 L SPORT 4K	Lente asimmetrico Sport <i>Asymmetric Sport lens</i>	145	4000	>80	28800	24723	171	5.9
43121	FLOOD M SDB 190 L SPORT 4K	Lente asimmetrico Sport <i>Asymmetric Sport lens</i>	190	4000	>80	36100	29260	154	5.9
43124	FLOOD M SDB 230 L SPORT 4K	Lente asimmetrico Sport <i>Asymmetric Sport lens</i>	230	4000	>80	43100	34914	152	5.9
43127	FLOOD M SDB 145 L CONC 4K	Lente simmetrico concentrante <i>Symmetrical concentrating lens</i>	145	4000	>80	28800	24723	171	5.9
43130	FLOOD M SDB 190 L CONC 4K	Lente simmetrico concentrante <i>Symmetrical concentrating lens</i>	190	4000	>80	36100	29260	154	5.9
43133	FLOOD M SDB 230 L CONC 4K	Lente simmetrico concentrante <i>Symmetrical concentrating lens</i>	230	4000	>80	43100	34914	152	5.9
43136	FLOOD M SDB 145 L DIF 4K	Lente simmetrico diffondente <i>Symmetrical diffusing lens</i>	145	4000	>80	28800	24723	171	5.9
43139	FLOOD M SDB 190 L DIF 4K	Lente simmetrico diffondente <i>Symmetrical diffusing lens</i>	190	4000	>80	36100	29260	154	5.9
43142	FLOOD M SDB 230 L DIF 4K	Lente simmetrico diffondente <i>Symmetrical diffusing lens</i>	230	4000	>80	43100	34914	152	5.9
43145	FLOOD M SDB 145 R AS 4K	Riflettore asimmetrico <i>Asymmetric reflector</i>	145	4000	>80	28800	25042	173	5.9
43148	FLOOD M SDB 180 R AS 4K	Riflettore asimmetrico <i>Asymmetric reflector</i>	180	4000	>80	34200	29700	165	5.9
43151	FLOOD M SDB 225 R AS 4K	Riflettore asimmetrico <i>Asymmetric reflector</i>	230	4000	>80	43400	37697	164	5.9
43154	FLOOD M SDB 145 R CONC 4K	Riflettore simmetrico concentrante <i>Symmetrical concentrating reflector</i>	145	4000	>80	28800	25042	173	5.9
43157	FLOOD M SDB 190 R CONC 4K	Riflettore simmetrico concentrante <i>Symmetrical concentrating reflector</i>	190	4000	>80	36100	31350	165	5.9
43160	FLOOD M SDB 230 R CONC 4K	Riflettore simmetrico concentrante <i>Symmetrical concentrating reflector</i>	230	4000	>80	43100	37444	163	5.9
43163	FLOOD M SDB 145 R DIF 4K	Riflettore simmetrico diffondente <i>Symmetrical diffusing reflector</i>	145	4000	>80	28800	25042	173	5.9
43166	FLOOD M SDB 190 R DIF 4K	Riflettore simmetrico diffondente <i>Symmetrical diffusing reflector</i>	190	4000	>80	36100	31350	165	5.9
43169	FLOOD M SDB 230 R DIF 4K	Riflettore simmetrico diffondente <i>Symmetrical diffusing reflector</i>	230	4000	>80	43100	37444	163	5.9

VARIANTI CON DIVERSA TEMPERATURA COLORE (K) / VERSIONS WITH DIFFERENT COLOUR TEMPERATURES (K)

Gli apparecchi sono disponibili anche in versione **3000K e 6000K**. L'elenco dei codici relativi è visionabile nell'**Indice analitico**, in calce ai codici su indicati con 4000K
The luminaires are also available in **3000K and 6000K** versions. A list of the related codes can be found in the **Analytical Index**, under the above codes with 4000K

SEGUE / NEXT >

125 proiettori da esterno / outdoor floodlights

Flood MODULA - M

ACCESSORI - da ordinare separatamente / ACCESSORIES - to be ordered separately



GRIGLIA FLOOD MODULA M
FLOOD MODULA M GRID

Cod. **12667**



KIT SOSPENSIONE RIFLETTORE
LIGHT SUSPENSION KIT

CAVI SOSPENSIONE / CABLES - Cod. **12663**
GOLFARI / EYEBOLT - Cod. **12669**

SD ACCESSORI - da ordinare separatamente / ACCESSORIES - to be ordered separately



CENTRALE LOGICA
LOGICA CONTROL UNIT

SD LGFM - Cod. **21102**



MODULI AUTODIMMER/RADIO
AUTODIMMER/RADIO MODULES

AUTODIMMER - Cod. **15053**
AUTODIMMER + RADIO - Cod. **15054**



CONCENTRATORE WIFI BLUETOOTH
WiFi BLUETOOTH CONCENTRATOR
1 ingresso di controllo / 1 control input

Cod. **15064**



MODULO INTERFACCIA BLUETOOTH
BLUETOOTH MODULE INTERFACE
3 ingressi di controllo / 3 control inputs

Cod. **15065**



CONCENTRATORE BLUETOOTH EASY BOX
BLUETOOTH EASY BOX CONCENTRATOR

WiFi - Cod. **15174**
WiFi ETHERNET - Cod. **15074**



SENSORE PRESENZA
MOTION SENSOR

INDUSTR IP65 - Cod. **15063**
UFFICI IP40 - Cod. **15062**

Sistema di trasmissione wireless integrato che permette la comunicazione fra gli apparecchi in modo da realizzare gruppi che attuano gli stessi comandi senza aggiungere ulteriori cablaggi. Utilizzando il Modulo interfaccia Bluetooth è possibile comandare i gruppi in modalità wireless. Per gestire un impianto centralizzato da APP B.connect occorre integrare il Concentratore Bluetooth. *Integrated wireless transmission system for communication between luminaires in order to create groups with the same commands without adding further wiring. Using the Bluetooth Interface Module it is possible to control the groups wireless. To manage a centralized system from the B.connect APP, the Bluetooth concentrator must be integrated.*

EMERGENZA CON INVERTER LED - da ordinare separatamente **EMERGENCY LED INVERTER - to be ordered separately**



MODULO/MODULE TR - LG230 - LG24 - EPS

TR - Cod. **15069** (6W 1/3h)
LG24 - Cod. **15071** - versione SD / SD Version
LG230 - Cod. **15070** - versione SD / SD Version
LG EPS - Cod. **15072** - versione SD / SD Version

Versione con emergenza integrata tipo **TR** si ottiene sostituendo la Staffa di derivazione Modula con la versione opzionale **TR**.

TR emergency by replacing the Modula box bracket with the optional Modula box bracket TR version.



127 *proiettori da esterno / outdoor floodlights*

Floodlight FL



IP66

IK07

950°

+40°C
-20°C



Caratteristiche

Mantenimento flusso luminoso a 25°C
>50.000h (L70B50)

Installazioni Suolo o parete

Corpo Alluminio pressofuso

Ottica PVC verniciato bianco, diffondente, simmetrica

Schermo Vetro temprato trasparente

Conformità EN605981 - EN60598-2-1
EN 62471

Applicazioni

Residenziale, terziario, industriale

Characteristics

Luminous flux retention at 25°C
>50.000h (L70B50)

Mounting Floor or wall

Housing Diecast Aluminium

Optics White painted PVC, symmetrical, diffusing

Compliance EN605981 - EN60598-2-1
EN 62471

Applications

Residential, services sector, industry

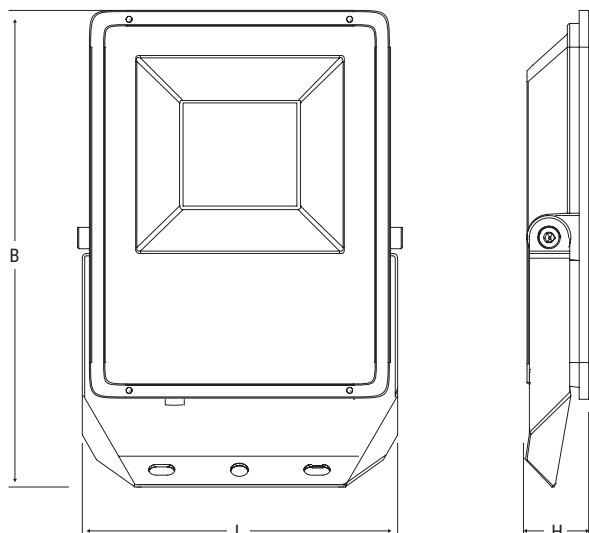

W	Dimensioni Dimension mm		
	L	B	H
10	97	110	27
20	118	141	33
30	136	163	33
50	146	175	33
100	252	222	38
200	390	265	38

FL/FL-DUAL SENSOR

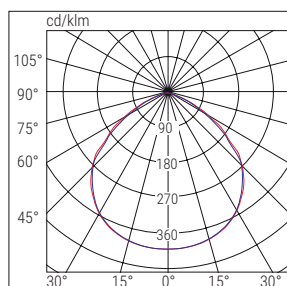

■ C0-C180 ■ C90-C270

FL-ALTE PRESTAZIONI

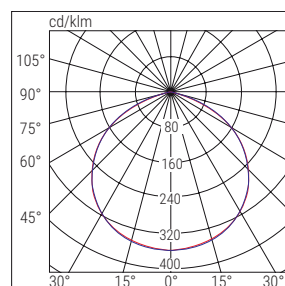

■ C90-C270 ■ C0-C180



FLOODLIGHT DUAL SENSOR

Sistema esclusivo che integra nel proiettore un sensore di presenza ed un sensore crepuscolare attivabili contestualmente e programmabili da telecomando in dotazione.

System that integrates a motion sensor and a light sensor inside the luminaire that can be activated at the same time and programmed from the supplied remote control.

FUNZIONI DEL TELECOMANDO

- Accensione/spengimento luce
- attivazione/disattivazione sensore crepuscolare e sensore di presenza
- Programmazione distanza di intervento del sensore di presenza
- Programmazione del tempo di stand-by del sensore di presenza

REMOTE CONTROL FUNCTIONS

- Switch ON / OFF
- Switch ON /switch OFF light sensor and motion sensor
- Programming distance of the motion sensor
- Programming stand-by time of the motion sensor



129 proiettori da esterno / outdoor floodlights

Floodlight FL

FLOODLIGHT

	Cod.	Descrizione Description	Potenza Power W	Temp. colore Colour Temp. K	CRI	Flusso LED LED Flux lm (Tj=25°C)	Flusso Flux lm	Efficienza Efficiency lm/W	Kg	Colore Color	
LED	86145	FL LED 10W BIANCO IP66 3K	10	3000	>80	1200	1000	100	0.2	○	ON / OFF
	86146	FL LED 20W BIANCO IP66 3K	20	3000	>80	2400	2000	100	0.35	○	
	86147	FL LED 30W BIANCO IP66 3K	30	3000	>80	3600	3000	100	0.45	○	
	86148	FL LED 50W BIANCO IP66 3K	50	3000	>80	6000	5000	100	0.55	○	
	86149	FL LED 10W BIANCO IP66 4K	10	4000	>80	1200	1000	100	0.2	○	
	86150	FL LED 20W BIANCO IP66 4K	20	4000	>80	2400	2000	100	0.35	○	
	86151	FL LED 30W BIANCO IP66 4K	30	4000	>80	3600	3000	100	0.45	○	
	86152	FL LED 50W BIANCO IP66 4K	50	4000	>80	6000	5000	100	0.55	○	
	86153	FL LED 20W BIANCO IP66 6K5	20	6500	>80	2400	2000	100	0.35	○	
	86154	FL LED 30W BIANCO IP66 6K5	30	6500	>80	3600	3000	100	0.45	○	
	86156	FL LED 10W NERO IP66 3K	10	3000	>80	1200	1000	100	0.2	●	
	86157	FL LED 20W NERO IP66 3K	20	3000	>80	2400	2000	100	0.35	●	
	86158	FL LED 30W NERO IP66 3K	30	3000	>80	3600	3000	100	0.45	●	
	86159	FL LED 50W NERO IP66 3K	50	3000	>80	6000	5000	100	0.55	●	
	86160	FL LED 10W NERO IP66 4K	10	4000	>80	1200	1000	100	0.2	●	
	86161	FL LED 20W NERO IP66 4K	20	4000	>80	2400	2000	100	0.35	●	
	86162	FL LED 30W NERO IP66 4K	30	4000	>80	3600	3000	100	0.45	●	
	86163	FL LED 50W NERO IP66 4K	50	4000	>80	6000	5000	100	0.55	●	
	86164	FL LED 20W NERO IP66 6K5	20	6500	>80	2400	2000	100	0.2	●	
86165	FL LED 30W NERO IP66 6K5	30	6500	>80	3600	3000	100	0.45	●		

DUAL SENSOR

	Cod.	Descrizione Description	Potenza Power W	Temp. colore Colour Temp. K	CRI	Flusso LED LED Flux lm (Tj=25°C)	Flusso Flux lm	Efficienza Efficiency lm/W	Kg	Colore Color	
LED	86179	FL LED 10W WHITE IP66 SENS 4K	10	4000	>80	1200	1000	100	0.2	○	ON / OFF
	86180	FL LED 20W WHITE IP66 SENS 4K	20	4000	>80	2400	2000	100	0.35	○	
	86181	FL LED 30W WHITE IP66 SENS 4K	30	4000	>80	3600	3000	100	0.45	○	
	86167	FL LED 20W NERO IP66 SENS 3K	20	3000	>80	2400	2000	100	0.35	●	
	86168	FL LED 50W NERO IP66 SENS 3K	50	3000	>80	6000	5000	100	0.55	●	
	86182	FL LED 10W NERO IP66 SENS 4K	10	4000	>80	1200	1000	100	0.2	●	
	86169	FL LED 20W NERO IP66 SENS 4K	20	4000	>80	2400	2000	100	0.35	●	
	86183	FL LED 30W NERO IP66 SENS 4K	30	4000	>80	3600	3000	100	0.45	●	
	86170	FL LED 50W NERO IP66 SENS 4K	50	4000	>80	6000	5000	100	0.55	●	
	86171	FL LED 20W NERO IP66 SENS 6K5	20	6500	>80	2400	2000	100	0.35	●	

ALTE PRESTAZIONI

	Cod.	Descrizione <i>Description</i>	Potenza <i>Power</i> W	Temp. colore <i>Colour Temp.</i> K	CRI	Flusso LED <i>LED Flux</i> lm (Tj=25°C)	Flusso <i>Flux</i> lm	Efficienza <i>Efficiency</i> lm/W	Kg	Colore <i>Color</i>
ED	86173	FL LED 100W NERO IP66 3K	100	3000	>80	11500	10000	100	1.315	●
	86176	FL LED 200W NERO IP66 3K	200	3000	>80	22500	20000	100	2.65	●
	86174	FL LED 100W NERO IP66 4K	100	4000	>80	11500	10000	100	1.315	●
	86177	FL LED 200W NERO IP66 4K	200	4000	>80	22500	20000	100	2.65	●

ON / OFF



131 proiettori da esterno / outdoor floodlights

Flood Mini



IP66

IK09

960°

+40°C
-20°C

Caratteristiche

Mantenimento flusso luminoso a 25°C

>50.000h (F70) (L80B20)

>60.000h (F30-F50) (L80B20)

Installazioni al suolo, parete

Corpo Alluminio pressofuso verniciato alle polveri di poliestere, RAL 7040

Ottica Lamellare a sviluppo parabolico in alluminio anodizzato brillantato antiriflescente. Simmetrico, Asimmetrico

Schermo Vetro prismatico temprato 4mm di spessore

Conformità EN 60598-1, EN 60598-2-22, EN 62471 (Rischio biologico esente), EN60598-2-2, 2014/30/UE, 2014/35/UE, EN60598-2-22

Applicazioni

Industriale, terziario, civile

Characteristics

Luminous flux retention at 25°C

>50,000h (F70) (L80B20)

>60,000h (F30-F50) (L80B20)

Mounting Floor, wall

Housing Polyester powder-coated die-cast Aluminium, RAL 7040

Optics Anti-iridescent polished Aluminium reflector. Symmetrical, Asymmetrical

Screen Tempered glass prism, 4mm thick

Compliance EN 60598-1, EN 60598-2-22, EN 62471 (photobiological risk-free), EN 60598-2-2, 2014/30/EU, 2014/35/EU

Applications

Industry, services sector, residential

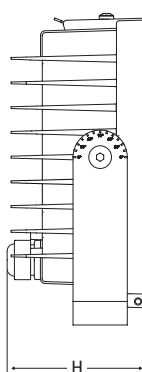
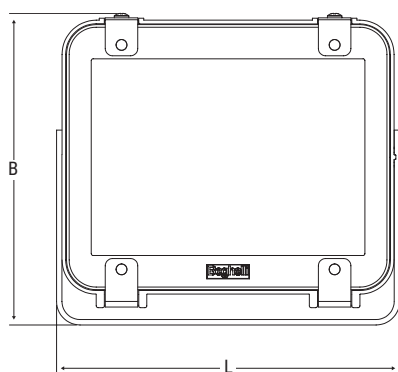

Dimensioni
Dimension
mm

L	B	H
190	173	75.5

FLOOD MINI OTTICA ASIMMETRICA / ASYMMETRIC OPTIC

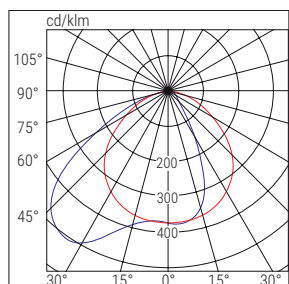

■ C90-C270 ■ C0-C180

FLOOD MINI OTTICA SIMMETRICA / SYMMETRIC OPTIC

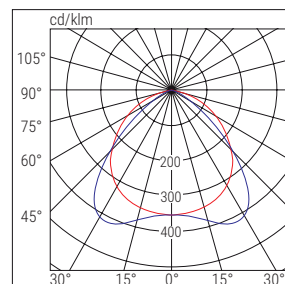

■ C90-C270 ■ C0-C180

	Cod.	Descrizione Description	Ottica Optics	Potenza Power W	Temp. colore Colour Temp. K	CRI	Flusso LED LED Flux lm (Tj=25°C)	Flusso Flux lm	Efficienza Efficiency lm/W	Kg	
ED	F30LED	PRO LED 1x30W 4K	SYM / ASYM	17	4000	>80	2100	1800	105	1.2	ON / OFF
	F50LED	PRO LED 1x50W 4K	SYM / ASYM	26	4000	>80	3500	3000	115	1.2	
	F70LED	PRO LED 1x70W 4K	SYM / ASYM	37	4000	>80	4600	4000	108	1.2	

ACCESSORI - in dotazione / ACCESSORIES - included

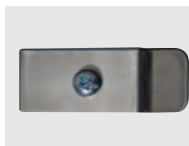

VITI ANTIVANDALICHE
VANDAL-PROOF SCREWS



STAFFA GONIOMETRICA
GONIOMETRIC BRACKET



PRESSACAVO M20 CON VALVOLA DI
VENTILAZIONE
M20 CABLE GLAND WITH VENTILATION
VALVE

ACCESSORI - da ordinare separatamente / ACCESSORIES - to be ordered separately



RICEVITORE RADIO DOMOTICO
BUILDING AUTOMATION REMOTE CONTROL
RECEIVER

Cod. 20108

FH-M



WEB CATALOGUE



IP66

IK09

960°

+40°C
-20°C

EMERGENZA

+40°C
0°C



Caratteristiche

Mantenimento flusso luminoso a 25°C
>70.000h (75W) (L80B20)

Installazioni al suolo, parete, torri faro, sospensione, plafone

Corpo Alluminio pressofuso verniciato alle polveri di poliestere RAL 7040

Ottica Lamellare a sviluppo parabolico in alluminio anodizzato brillantato antiriflescente. Simmetrico, asimmetrico.

Schermo Vetro temprato prismatico

Conformità EN 60598-1, EN 60598-2-1, EN 60598-2-22, DIN 18031-3, EN 62471 (Rischio biologico esente), 2014/53/UE, EN60598-2-22

Applicazioni

Industriale, terziario, civile

Characteristics

Luminous flux retention at 25°C
>70,000h (75W) (L80B20)

Mounting Floor, wall, lighthouse towers, suspended, ceiling

Housing Polyester powder-coated die-cast aluminium, RAL 7040

Optics Anti-iridescent polished Aluminium reflector. Symmetrical, Asymmetrical

Screen Tempered glass prism, 4mm

Compliance EN 60598-1, EN 60598-2-1, EN 60598-2-22, DIN 18031-3, EN 62471 (photobiological risk-free), 2014/53/EU

Applications

Industry, services sector, residential

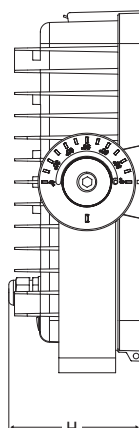
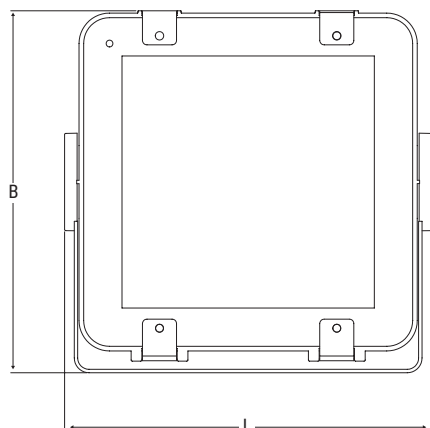

Dimensioni
Dimensions
mm

L	B	H
323	319	116

FH-M OTTICA ASIMMETRICA / ASYMMETRIC OPTIC

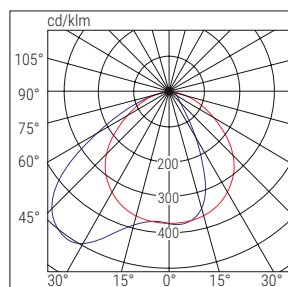

■ C90-C270 ■ C0-C180

FH-M OTTICA SIMMETRICA / SYMMETRIC OPTIC

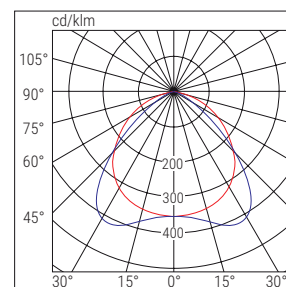

■ C90-C270 ■ C0-C180

	Cod.	Descrizione Description	Ottica Optics	Potenza Power W	Temp. colore Colour Temp. K	CRI	Flusso LED LED Flux lm (T _j =25°C)	Flusso Flux lm	Efficienza Efficiency lm/W	Kg	
RD	40801	PRO/RIF 50W REGOLABILE 4K	Simmetrica/asimmetrica Symmetrical/asymmetrical	50	4000	>80	7800	7430	161	4	REGOLABILE
	40804	PRO/RIF 100W REGOLABILE 4K	Simmetrica/asimmetrica Symmetrical/asymmetrical	100	4000	>80	15600	14073	160	4	
DALI	40801DL	PRO/RIF 75W DALI 4K	Simmetrica/asimmetrica Symmetrical/asymmetrical	74	4000	>80	12000	11984	162	4	DALI
	40804DL	PRO/RIF 100W DALI 4K	Simmetrica/asimmetrica Symmetrical/asymmetrical	100	4000	>80	18000	15300	153	4	
SDO	40941	PRO/RIF 75W SDB 4K	Simmetrica/asimmetrica Symmetrical/asymmetrical	74	4000	>80	12000	11984	162	4	BLUETOOTH
	40944	PRO/RIF 100W SDB 4K	Simmetrica/asimmetrica Symmetrical/asymmetrical	100	4000	>80	18000	15300	153	4	

RD FLUSSO-POTENZA REGOLABILI / ADJUSTABLE FLUX-POWER



Flusso /Potenza Flux/Power	Cod. 40801			Cod. 40804		
	lm	W	lm/W	lm	W	lm/W
STEP 1	7430	50	149	14073	100	141
STEP 2	6496	42	153	12464	84	148
STEP 3	5586	35	158	10777	70	154
STEP 4	4561	28	161	8893	56	160

Driver RD dotato di switch con 4 step di modulazione della corrente in modo da assicurare la massima efficienza luminosa, e quindi il massimo risparmio energetico, utilizzando solo il flusso luminoso determinato in fase di progettazione / RD driver equipped with a switch with 4 steps of current modulation in order to ensure maximum luminous efficiency, and therefore maximum energy saving, using only the luminous flux determined in the design phase.

VARIANTI SPECIALI - a richiesta

RESA CROMATICA ≥90 - TEMPERATURA COLORE A RICHIESTA - VERSIONE CON DIFFUSORE IN POLICARBONATO PER AMBIENTI HACCP (IP54)
CHROMATIC YIELD ≥90 - COLOUR TEMPERATURE ON REQUEST - VERSION WITH POLYCARBONATE DIFFUSER FOR HACCP ENVIRONMENTS (IP54)

FH-M

ACCESSORI - in dotazione / ACCESSORIES - included



VITI ANTIVANDALICHE
VANDAL-PROOF SCREWS



STAFFA GONIOMETRICA
GONIOMETRIC BRACKET



**PRESSACAVO M20 CON VALVOLA
DI VENTILAZIONE**
M20 CABLE GLAND WITH VENTILATION
VALVE

ACCESSORI - da ordinare separatamente / ACCESSORIES - to be ordered separately



**STAFFA DI FISSAGGIO SU BARRA
ELETTTRIFICATA**
MOUNTING BRACKET FOR ELECTRIFIED BAR

Cod. 12659



STAFFA DI FISSAGGIO A PLAFONE
CEILING MOUNTING BRACKET

Cod. 12664



TESTA PALO 2X 60-76
POLE END CAP 2X 60-76

Cod. 12661



TESTA PALO 4X 60-76
POLE END CAP 4X 60-76

Cod. 12662



CAVO SOSPENSIONE RIFLETTORE
HIGH BAY LIGHT SUSPENSION CABLE

Cod. 12663



GRIGLIA PROTEZIONE
PROTECTIVE GRID

Cod. 12657

SD ACCESSORI - da ordinare separatamente / ACCESSORIES - to be ordered separately



CENTRALE LOGICA
LOGICA CONTROL UNIT

SD LGFM - Cod. 21102



MODULI AUTODIMMER/RADIO
AUTODIMMER/RADIO MODULES

AUTODIMMER - Cod. 15053
AUTODIMMER + RADIO - Cod. 15054



CONCENTRATORE WIFI BLUETOOTH
WIFI BLUETOOTH CONCENTRATOR
1 ingresso di controllo / 1 control input

Cod. 15064



MODULO INTERFACCIA BLUETOOTH
BLUETOOTH MODULE INTERFACE
3 ingressi di controllo / 3 control inputs

Cod. 15065



CONCENTRATORE BLUETOOTH EASY BOX
BLUETOOTH EASY BOX CONCENTRATOR

WiFi - Cod. 15174
WiFi ETHERNET - Cod. 15074





SENSORE PRESENZA
MOTION SENSOR

INDUSTR IP65 - Cod. 15063
UFFICI IP40 - Cod. 15062

Sistema di trasmissione wireless integrato che permette la comunicazione fra gli apparecchi in modo da realizzare gruppi che attuano gli stessi comandi senza aggiungere ulteriori cablaggi. Utilizzando il Modulo interfaccia Bluetooth è possibile comandare i gruppi in modalità wireless. Per gestire un impianto centralizzato da APP B.connect occorre integrare il Concentratore Bluetooth. Integrated wireless transmission system for communication between luminaires in order to create groups with the same commands without adding further wiring. Using the Bluetooth Interface Module it is possible to control the groups wireless. To manage a centralized system from the B.connect APP, the Bluetooth concentrator must be integrated.

APPARECCHIO + EMERGENZA CON INVERTER LED PRECABLATO - codifica componibile
LUMINAIRE + EMERGENCY WITH PRE-WIRED LED INVERTER - modular coding

INVERTER INTEGRATO BUILT-IN INVERTER	DESINENZA SUFFIX	SISTEMA DI EMERGENZA EMERGENCY SYSTEM	AUTONOMIA (h) AUTONOMY (h)	POTENZA LED (W) LED POWER (W)
	TR1	TR	1	3
	TR3	TR	3	3
	AT	AT	1/1.5/2/3/8	5/3.3/2.5/1.7/0.7
	CT	CT	1/1.5/2/3/8	5/3.3/2.5/1.7/0.7

MODULO / MODULE LG - LGFM - DALI
 Solo per Inverter CT / For CT Inverters only

LG
LGFM
DALI

LG - Cod. 15079
LGFM - Cod. 15037
DALI - Cod. 15080

BOOSTER BATTERY (AT - CT version)

1 Batteria - Raddoppia Potenza 10W e Flusso emergenza
 2 Batteria - Triplica Potenza 15W e Flusso emergenza
 1 Battery - Double Power 10W and emergency Flux
 2 Battery - Triple Power 15W and emergency Flux

Cod. **RA13**

Ogni apparecchio di questa serie può essere **configurato e precablato direttamente in Beghelli**, già pronto per l'installazione. Per ordinarlo è necessario creare il codice specificando il sistema di controllo utilizzando come segue le presenti tabelle: **Cod. APPARECCHIO + DESINENZA**, per esempio per ordinare un proiettore FH-L in versione CentralTest (CT) occorre aggiungere al Cod. **40801** la desinenza CT = Cod. **40801CT**

Each unit in this series can be **configured and pre-wired directly in Beghelli**, ready for installation. For orders, create the code by specifying the control system using the following tables: **Cod. LUMINAIRE + SUFFIX**, for example, to order an CentralTest (CT) FH-L floodlight, add to the Cod. **40801** the suffix CT = Cod. **40801CT**



FH-L



WEB
CATALOGUE



IP66

IK09

960°

+40°C
-20°C

EMERGENZA

+40°C
0°C



Caratteristiche

Mantenimento flusso luminoso a 25°C
>70.000h (L80B20)

Installazioni al suolo, parete, torri faro, sospensione

Corpo Alluminio pressofuso verniciato alle polveri di poliestere RAL 7040

Ottica Lamellare in alluminio anodizzato brillantato antiriflescente. Simmetrica/Asimmetrica.

Schermo Vetro temprato prismaticizzato 4mm

Conformità EN 60598-1, EN 60598-2-1, EN 60598-2-22, DIN 18031-3, EN 62471 (Rischio biologico esente), EN61493, 2014/53/UE, EN60598-2-22

Applicazioni

Industriale, terziario, civile

Characteristics

Luminous flux retention at 25°C
>70,000h (L80B20)

Mounting Floor, wall, lighthouse towers, suspended

Housing Polyester powder-coated die-cast aluminium, RAL 7040

Optics Anti-iridescent polished Aluminium reflector. Symmetrical, Asymmetrical

Screen Tempered glass prism, 4mm

Compliance EN 60598-1, EN 60598-2-1, EN 60598-2-22, DIN 18031-3, EN 62471 (photobiological risk-free), EN 61493, 2014/53/EU

Applications

Industry, services sector, residential

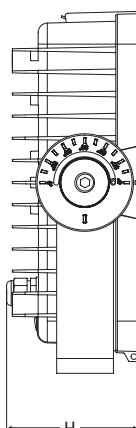
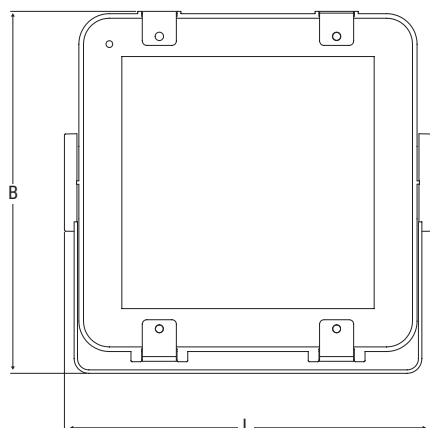

Dimensioni
Dimensions
mm

L	B	H
348	434	121

ASIMMETRICA / ASYMMETRICAL

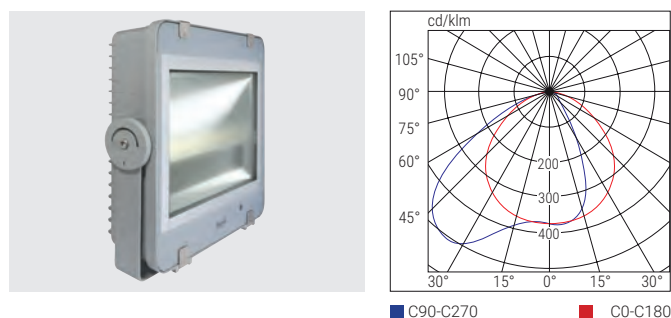

DIFFONDEnte SIMMETRICA / SYMMETRICAL DIFFUSING

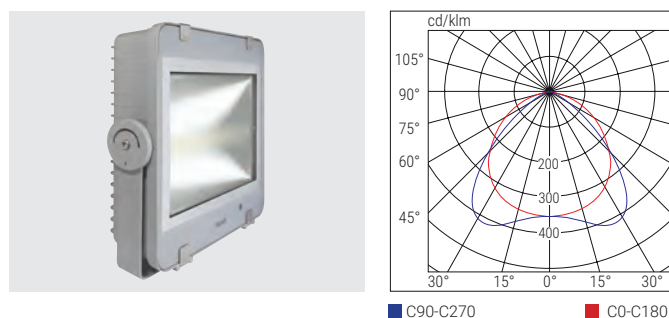

	Cod.	Descrizione Description	Ottica Optics	Potenza Power W	Temp. colore Colour Temp. K	CRI	Flusso LED LED Flux lm (Tj=25°C)	Flusso Flux lm	Efficienza Efficiency lm/W	Kg	
RD	40861	PRO/RIF 150W REGOLABILE 4K	Simmetrica/asimmetrica Symmetrical/asymmetrical	151	4000	>80	25000	23143	153	8.8	REGOLABILE
	40864	PRO/RIF 200W REGOLABILE 4K	Simmetrica/asimmetrica Symmetrical/asymmetrical	203	4000	>80	30500	27878	138	8.8	
DALI	40861DL	PRO/RIF 150W DALI 4K	Simmetrica/asimmetrica Symmetrical/asymmetrical	150	4000	>80	27000	24907	166	8.8	DALI
	40864DL	PRO/RIF 200W DALI 4K	Simmetrica/asimmetrica Symmetrical/asymmetrical	200	4000	>80	35500	32400	162	8.8	
SDB	40891	PRO/RIF 150W SDB 4K	Simmetrica/asimmetrica Symmetrical/asymmetrical	150	4000	>80	27000	24907	166	8.8	BLUETOOTH
	40894	PRO/RIF 200W SDB 4K	Simmetrica/asimmetrica Symmetrical/asymmetrical	200	4000	>80	35500	32400	162	8.8	

RD FLUSSO-POTENZA REGOLABILI / ADJUSTABLE FLUX-POWER



Flusso /Potenza Flux/Power	Cod. 40861			Cod. 40864		
	lm	W	lm/W	lm	W	lm/W
STEP 1	23143	151	153	27878	203	138
STEP 2	20266	128	158	24754	172	144
STEP 3	17380	107	162	21497	143	150
STEP 4	14229	85	167	17769	114	156

Driver RD dotato di switch con 4 step di modulazione della corrente in modo da assicurare la massima efficienza luminosa, e quindi il massimo risparmio energetico, utilizzando solo il flusso luminoso determinato in fase di progettazione / RD driver equipped with a switch with 4 steps of current modulation in order to ensure maximum luminous efficiency, and therefore maximum energy saving, using only the luminous flux determined in the design phase.

VARIANTI SPECIALI - a richiesta

RESA CROMATICA ≥90 - TEMPERATURA COLORE A RICHIESTA - VERSIONE CON DIFFUSORE IN POLICARBONATO PER AMBIENTI HACCP (IP54)
CHROMATIC YIELD ≥90 - COLOUR TEMPERATURE ON REQUEST - VERSION WITH POLYCARBONATE DIFFUSER FOR HACCP ENVIRONMENTS (IP54)

ACCESSORI - in dotazione / ACCESSORIES - included



VITI ANTIVANDALICHE
VANDAL-PROOF SCREWS



STAFFA GONIOMETRICA
GONIOMETRIC BRACKET



PRESSACAVO M20 CON VALVOLA DI VENTILAZIONE
M20 CABLE GLAND WITH VENT VALVE

ACCESSORI - da ordinare separatamente / ACCESSORIES - to be ordered separately



STAFFA DI FISSAGGIO SU BARRA ELETTRIFICATA
MOUNTING BRACKET FOR ELECTRIFIED BAR

Cod. 12659



STAFFA DI FISSAGGIO A PLAFONE
CEILING MOUNTING BRACKET

Cod. 12664



TESTA PALO 2X 60-76
POLE END CAP 2X 60-76

Cod. 12661



TESTA PALO 4X 60-76
POLE END CAP 4X 60-76

Cod. 12662



CAVO SOSPENSIONE RIFLETTORE
HIGH BAY LIGHT SUSPENSION CABLE

Cod. 12663



GRIGLIA PROTEZIONE
PROTECTIVE GRID

Cod. 12658

SD ACCESSORI - da ordinare separatamente / ACCESSORIES - to be ordered separately



CENTRALE LOGICA
LOGICA CONTROL UNIT

SD LGFM - Cod. 21102



MODULI AUTODIMMER/RADIO
AUTODIMMER/RADIO MODULES

AUTODIMMER - Cod. 15053
AUTODIMMER + RADIO - Cod. 15054



CONCENTRATORE WIFI BLUETOOTH
WIFI BLUETOOTH CONCENTRATOR
1 ingresso di controllo / 1 control input

Cod. 15064



MODULO INTERFACCIA BLUETOOTH
BLUETOOTH MODULE INTERFACE
3 ingressi di controllo / 3 control inputs

Cod. 15065



CONCENTRATORE BLUETOOTH EASY BOX
BLUETOOTH EASY BOX CONCENTRATOR

WiFi - Cod. 15174
WiFi ETHERNET - Cod. 15074





SENSORE PRESENZA
MOTION SENSOR

INDUSTR IP65 - Cod. 15063
UFFICI IP40 - Cod. 15062

Sistema di trasmissione wireless integrato che permette la comunicazione fra gli apparecchi in modo da realizzare gruppi che attuano gli stessi comandi senza aggiungere ulteriori cablaggi. Utilizzando il Modulo interfaccia Bluetooth è possibile comandare i gruppi in modalità wireless. Per gestire un impianto centralizzato da APP B.connect occorre integrare il Concentratore Bluetooth. Integrated wireless transmission system for communication between luminaires in order to create groups with the same commands without adding further wiring. Using the Bluetooth Interface Module it is possible to control the groups wireless. To manage a centralized system from the B.connect APP, the Bluetooth concentrator must be integrated.

APPARECCHIO + EMERGENZA CON INVERTER LED PRECABLATO - codifica componibile
LUMINAIRE + EMERGENCY WITH PRE-WIRED LED INVERTER - modular coding

INVERTER INTEGRATO BUILT-IN INVERTER	DESINENZA SUFFIX	SISTEMA DI EMERGENZA EMERGENCY SYSTEM	AUTONOMIA (h) AUTONOMY (h)	POTENZA LED (W) LED POWER (W)
	TR1	TR	1	3
	TR3	TR	3	3
	AT	AT	1/1.5/2/3/8	5/3.3/2.5/1.7/0.7
	CT	CT	1/1.5/2/3/8	5/3.3/2.5/1.7/0.7



MODULO / MODULE LG - LGFM - DALI

Solo per Inverter CT / For CT Inverters only

LG - Cod. **15079**
LGFM - Cod. **15037**
DALI - Cod. **15080**



BOOSTER BATTERY (AT - CT version)

1 Batteria - Raddoppia Potenza 10W e Flusso emergenza
 2 Batteria - Triplica Potenza 15W e Flusso emergenza
 1 Battery - Double Power 10W and emergency Flux
 2 Battery - Triple Power 15W and emergency Flux
 Cod. **RA13**

Ogni apparecchio di questa serie può essere **configurato e precablato direttamente in Beghelli**, già pronto per l'installazione. Per ordinarlo è necessario creare il codice specificando il sistema di controllo utilizzando come segue le presenti tabelle: **Cod. APPARECCHIO + DESINENZA**, per esempio per ordinare un proiettore FH-L in versione CentralTest (CT) occorre aggiungere al Cod. **40861** la desinenza CT = Cod. **40861CT**

Each unit in this series can be **configured and pre-wired directly in Beghelli**, ready for installation. For orders, create the code by specifying the control system using the following tables: **Cod. LUMINAIRE + SUFFIX**, for example, to order an CentralTest (CT) FH-L floodlight, add to the Cod. **40861** the suffix CT = Cod. **40861CT**



VERSIONE EMERGENZA

Power Light



IP66

IK09

960°

+40°C
-20°C



Caratteristiche

Mantenimento flusso luminoso a 25°C
>50.000h (L70B20)

Installazioni Torre faro, muro, testa palo, pavimento

Corpo Alluminio pressofuso verniciato alle polveri di poliestere nero

Ottica Lenti in PMMA trasparente

Conformità EN 60598-1, EN 60598-2-22 DIN 18031-3, EN 62471 (Rischio biologico esente), EN60598-2-5, 2014/53/UE, EN60598-2-22

Applicazioni

Campi sportivi, sezioni stradali, piazzali industriali, parcheggi outdoor

Characteristics

Luminous flux retention at 25°C
>50,000h (L70B20)

Mounting Lighthouse tower, wall, pole, floor

Housing Polyester powder-coated die-cast aluminium, black

Optics Clear PMMA lenses

Compliance EN 60598-1, EN 60598-2-22 DIN 18031-3, EN 62471 (Biological risk-free), EN 60598-2-5, 2014/53/EU

Applications

Sports fields, road sections, industrial yards, outdoor car parks

* Gamma modulare fino a 1500W, disponibile sul WEB CATALOGUE consultabile su BEGHELLI.IT

Versione Version	Dimensioni Dimension mm				
	A	B	C	H	L
300W - 1 modulo	236	490	296	137	193
600W - 2 moduli	466	602	137	367	329
900W - 3 moduli	665	602	137	577	329
1200W - 4 moduli	801	606	137	747	520

VERSIONE 1 MODULO
1 MODULE VERSION

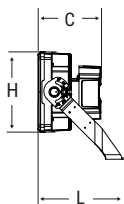
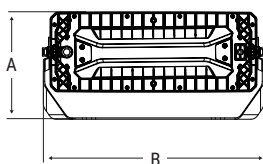

VERSIONE 2 MODULI
2 MODULES VERSION

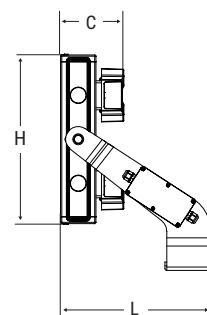
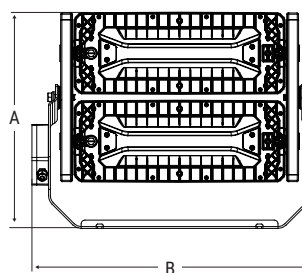

10°

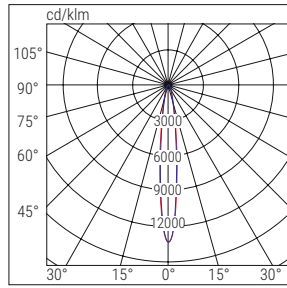
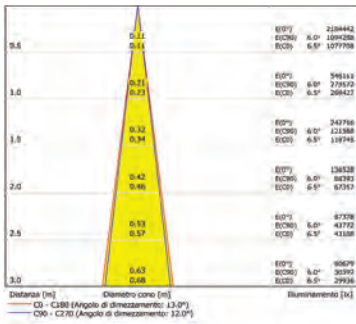

■ C0-C180 ■ C90-C270

30°

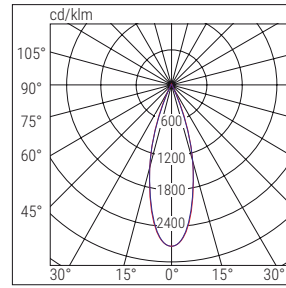
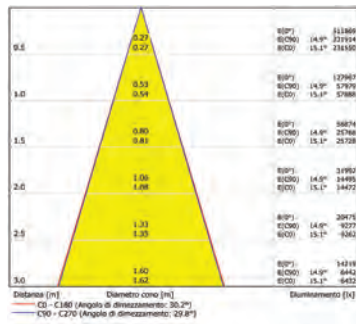

■ C0-C180 ■ C90-C270

60°

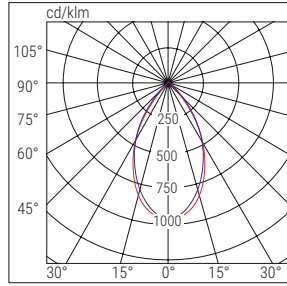
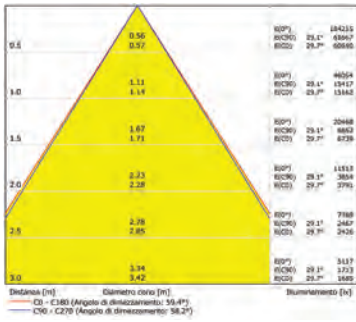

■ C0-C180 ■ C90-C270

ASIMMETRICA / ASYMMETRICAL

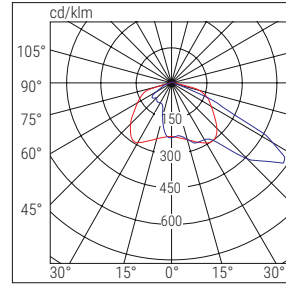
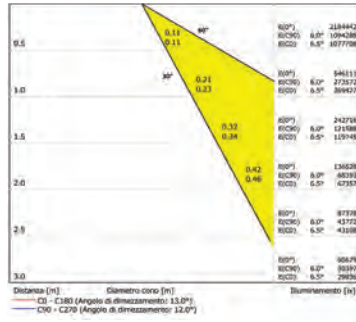

■ C0-C180 ■ C90-C270



SISTEMA MODULARE PER GRANDI AREE MODULAR SYSTEM FOR LARGE AREAS

PROIEZIONE LUMINOSA FINO A 170.000lm

Il proiettore è composto da un modulo base che può arrivare fino a 4 unità sovrapposte, orientabili individualmente.

STAFFA ORIENTABILE CON ATTACCO A 45°

Tutte le versioni sono dotate di staffa orientabile con attacco inclinato a 45°

LIGHT INTENSITY UP TO 170,000LM

The luminaire is composed of a basic module which can have up to 4 units aligned and each adjustable

ADJUSTABLE BRACKET

WITH A 45° INCLINED ATTACHMENT

All versions are equipped with an adjustable bracket with a 45° inclined attachment

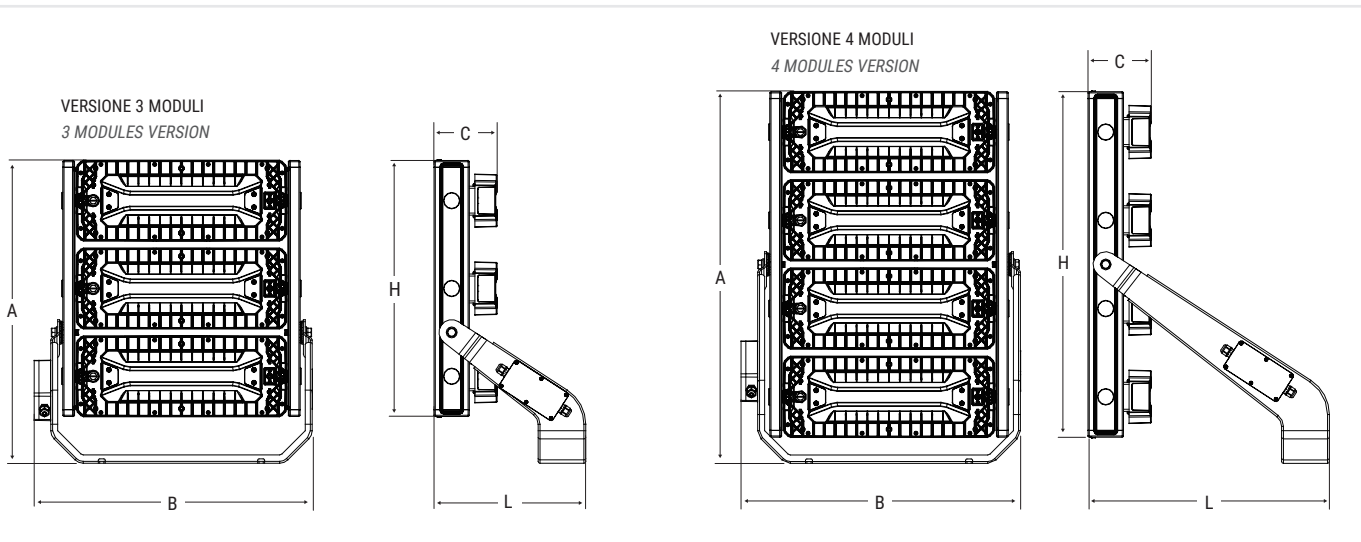

SEGUE / NEXT >

Power Light

	Cod.	Descrizione Description	Ottica Optics	Potenza Power W	Temp. colore Colour Temp. K	CRI	Flusso LED LED Flux lm (Tj=25°C)	Flusso Flux lm	Efficienza Efficiency lm/W	Kg
DALI	41400	POWER L DALI 300W C70 5k 30°	30°	300	5000	>70	50400	48000	160	6.5
	41401	POWER L DALI 600W C70 5k 30°	30°	600	5000	>70	100800	96000	160	18.5
	41402	POWER L DALI 900W C70 5k 30°	30°	900	5000	>70	180000	144000	160	31.8
	41403	POWER L DALI 1200W C70 5k 30°	30°	1200	5000	>70	225000	192000	160	39.4
	41404	POWER L DALI 300W C70 5k 60°	60°	300	5000	>70	50400	48000	160	6.5
	41405	POWER L DALI 600W C70 5k 60°	60°	600	5000	>70	100800	96000	160	18.5
	41406	POWER L DALI 900W C70 5k 60°	60°	900	5000	>70	180000	144000	160	31.8
	41407	POWER L DALI 1200W C70 5k 60°	60°	1200	5000	>70	225000	192000	160	39.4
	41408	POWER L DALI 300W C70 5k ASY	Asimmetrica / Asymmetric	300	5000	>70	50400	42000	140	6.5
	41409	POWER L DALI 600W C70 5k ASY	Asimmetrica / Asymmetric	600	5000	>70	100800	84000	140	18.5
	41410	POWER L DALI 900W C70 5k ASY	Asimmetrica / Asymmetric	900	5000	>70	180000	126000	140	31.8
	41411	POWER L DALI 1200W C70 5k ASY	Asimmetrica / Asymmetric	1200	5000	>70	225000	168000	140	39.4
	41424	POWER L DALI 300W C70 5k 10°	10°	300	5000	>70	50400	42000	140	6.5
	41425	POWER L DALI 600W C70 5k 10°	10°	600	5000	>70	100800	84000	140	18.5
41426	POWER L DALI 900W C70 5k 10°	10°	900	5000	>70	180000	126000	140	31.8	
41427	POWER L DALI 1200W C70 5k 10°	10°	1200	5000	>70	225000	168000	140	39.4	
SDI	41412	POWER L SDB 300W C70 5k 30°	30°	300	5000	>70	50400	48000	160	6.5
	41413	POWER L SDB 600W C70 5k 30°	30°	600	5000	>70	100800	96000	160	18.5
	41414	POWER L SDB 900W C70 5k 30°	30°	900	5000	>70	180000	144000	160	31.8
	41415	POWER L SDB 1200W C70 5k 30°	30°	1200	5000	>70	225000	192000	160	39.4
	41416	POWER L SDB 300W C70 5k 60°	60°	300	5000	>70	50400	48000	160	6.6
	41417	POWER L SDB 600W C70 5k 60°	60°	600	5000	>70	100800	96000	160	18.5
	41418	POWER L SDB 900W C70 5k 60°	60°	900	5000	>70	180000	144000	160	31.8
	41419	POWER L SDB 1200W C70 5k 60°	60°	1200	5000	>70	225000	192000	160	39.4
	41420	POWER L SDB 300W C70 5k ASY	Asimmetrica / Asymmetric	300	5000	>70	50400	42000	140	6.6
	41421	POWER L SDB 600W C70 5k ASY	Asimmetrica / Asymmetric	600	5000	>70	100800	84000	140	18.5
	41422	POWER L SDB 900W C70 5k ASY	Asimmetrica / Asymmetric	900	5000	>70	180000	126000	140	18.5
	41423	POWER L SDB 1200W C70 5k ASY	Asimmetrica / Asymmetric	1200	5000	>70	225000	168000	140	39.4
	41428	POWER L SDB 300W C70 5k 10°	10°	300	5000	>70	50400	42000	140	6.5
	41429	POWER L SDB 600W C70 5k 10°	10°	600	5000	>70	100800	84000	140	18.5
41430	POWER L SDB 900W C70 5k 10°	10°	900	5000	>70	180000	126000	140	31.8	
41431	POWER L SDB 1200W C70 5k 10°	10°	1200	5000	>70	225000	168000	140	39.4	

ACCESSORI - in dotazione / ACCESSORIES - included



**PRESSACAPO M20 CON VALVOLA
DI VENTILAZIONE**
M20 CABLE GLAND WITH VENT VALVE



STAFFA GONIOMETRICA
GONIOMETRIC BRACKET

SD  **ACCESSORI** - da ordinare separatamente / **ACCESSORIES** - to be ordered separately



CENTRALE LOGICA
LOGICA CONTROL UNIT

SD LGFM - Cod. **21102**



CONCENTRATORE BLUETOOTH EASY BOX
BLUETOOTH EASY BOX CONCENTRATOR

WiFi - Cod. **15174**
WiFi ETHERNET - Cod. **15074**



CONCENTRATORE WIFI BLUETOOTH
WiFi BLUETOOTH CONCENTRATOR
1 ingresso di controllo / 1 control input

Cod. **15064**



MODULO INTERFACCIA BLUETOOTH
BLUETOOTH MODULE INTERFACE
3 ingressi di controllo / 3 control inputs

Cod. **15065**



SENSORE PRESENZA
MOTION SENSOR

INDUSTR IP65 - Cod. **15063**
UFFICI IP40 - Cod. **15062**

Sistema di trasmissione wireless integrato che permette la comunicazione fra gli apparecchi in modo da realizzare gruppi che attuano gli stessi comandi senza aggiungere ulteriori cablaggi. Utilizzando il Modulo interfaccia Bluetooth è possibile comandare i gruppi in modalità wireless. Per gestire un impianto centralizzato da APP B.connect occorre integrare il Concentratore Bluetooth. *Integrated wireless transmission system for communication between luminaires in order to create groups with the same commands without adding further wiring. Using the Bluetooth Interface Module it is possible to control the groups wireless. To manage a centralized system from the B.connect APP, the Bluetooth concentrator must be integrated.*

Strada MODULA

illuminazione / lighting



IP66

IK08



960°

+40°C
-20°C

MEZZANOTTE VIRTUALE

Caratteristiche

Mantenimento flusso luminoso a 25°C

>70.000h (L80B20)

Installazioni Testa palo o braccio $\Phi 60$ mm

Corpo Alluminio pressofuso RAL 7040

Ottica PMMA ad elevata trasparenza

Schermo Vetro temprato

Conformità EN 60598-1, EN 60598-2-3, EN 60598-2-22, EN 62471 (rischio fotobiologico esente), 2014/53/UE, EN60598-2-22

Applicazioni

Stradale pubblico e privato, parcheggi, piste ciclabili

Characteristics

Luminous flux retention at 25°C

>70.000h (L80B20)

Mounting Pole or arm $\Phi 60$ mm

Housing Die-cast aluminium, RAL 7040

Optics PMMA lens

Screen Tempered glass

Compliance EN 60598-1, EN 60598-2-3, EN 60598-2-22, EN 62471 (rischio fotobiologico esente), 2014/53/UE, EN60598-2-22

Applications

Public and private roads, car parks, cycle paths

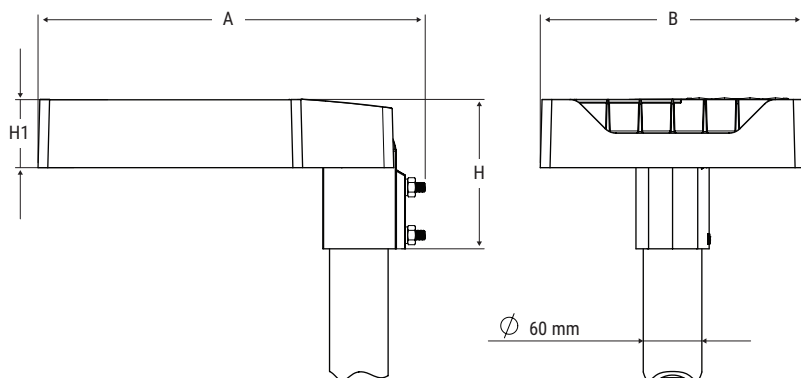

Dimensioni
Dimension
mm

L	B	H	H1	Ø
397	271	155	72	60



Asimmetrica ciclabile
Asymmetric cycle line

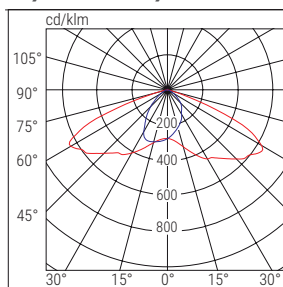

■ C90-C270 ■ C0-C180

Asimmetrico Parking
Asymmetric Parking

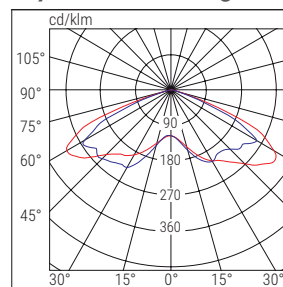

■ C90-C270 ■ C0-C180

Asimmetrico stradale
Asymmetric urban street

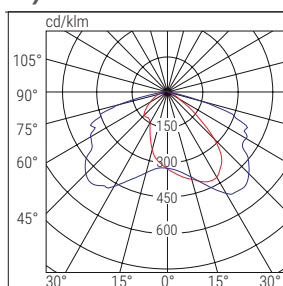

■ C90-C270 ■ C0-C180

Simmetrico Parking
Symmetrical Parking

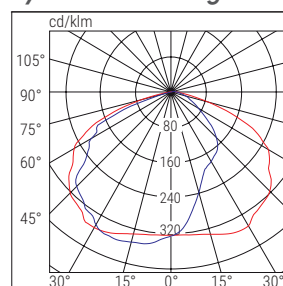

■ C90-C270 ■ C0-C180

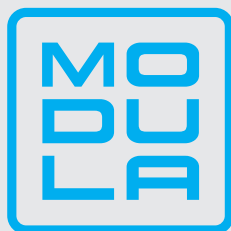

BOX DI DERVAZIONE CON VANO MORSETTIERA
JUNCTION BOX WITH TERMINAL BLOCK

Nel retro dell'armatura stradale è presente una scatola stagna in alluminio pressofuso per contenere la morsettiera di alimentazione e controllo
On the back of luminaires there is a waterproof aluminium junction box to contain the power and control terminal block



MODULO EMERGENZA TR
EMERGENCY TR MODULE

Accessorio per integrare l'illuminazione di emergenza nell'apparecchio. Il box, in Alluminio pressofuso, contiene l'elettronica e la batteria per la versione TR.

Accessory available to integrate emergency lighting into the luminaire. The box, in die-cast aluminium, contains the electronics and battery for the TR version.

Cod.	Descrizione <i>Description</i>	Ottica <i>Optics</i>	Potenza <i>Power</i> W	Temp. colore <i>Colour Temp.</i> K	CRI	Flusso LED <i>LED Flux</i> lm (Tj=25°C)	Flusso <i>Flux</i> lm	Efficienza <i>Efficiency</i> lm/W	Kg
45007	STREET S ED 60 L AS CYCLO 4K	Asimmetrico ciclabile <i>Asymmetric cycle line</i>	60	4000	>80	11100	9570	160	5
45010	STREET S ED 80 L AS CYCLO 4K	Asimmetrico ciclabile <i>Asymmetric cycle line</i>	80	4000	>80	14200	12320	154	5
45013	STREET S ED 110 L AS CYCLO 4K	Asimmetrico ciclabile <i>Asymmetric cycle line</i>	110	4000	>80	18300	15851	144	5
45022	STREET S ED 60 L AS PARK 4K	Asimmetrico Parking <i>Asymmetric Parking</i>	60	4000	>80	11100	9570	160	5
45025	STREET S ED 80 L AS PARK 4K	Asimmetrico Parking <i>Asymmetric Parking</i>	80	4000	>80	14200	12320	154	5
45028	STREET S ED 110 L AS PARK 4K	Asimmetrico Parking <i>Asymmetric Parking</i>	110	4000	>80	18300	15851	144	5

ED

ON-OFF

Strada MODULA

	Cod.	Descrizione Description	Ottica Optics	Potenza Power W	Temp. colore Colour Temp. K	CRI	Flusso LED LED Flux lm (Tj=25°C)	Flusso Flux lm	Efficienza Efficiency lm/W	Kg
ED	45037	STREET S ED 60 L AS STRA 4K	Asimmetrico Stradale Asymmetric Parking	60	4000	>80	11100	9570	160	5
	45040	STREET S ED 80 L AS STRA 4K	Asimmetrico Stradale Asymmetric Urban street	80	4000	>80	14200	12320	154	5
	45043	STREET S ED 110 L AS STRA 4K	Asimmetrico Stradale Asymmetric Urban street	110	4000	>80	18300	15851	144	5
	45052	STREET S ED 60 L SIM PARK 4K	Simmetrico Parking Symmetrical Parking	60	4000	>80	11100	9570	160	5
	45055	STREET S ED 80 L SIM PARK 4K	Simmetrico Parking Symmetrical Parking	80	4000	>80	14200	12320	154	5
	45058	STREET S ED 110 L SIM PARK 4K	Simmetrico Parking Symmetrical Parking	110	4000	>80	18300	15851	144	5
MEZZANOTTE VIRTUALE - DALI	45127	STREET S MV 60 L AS CYCLO 4K	Asimmetrico ciclabile Asymmetric cycle line	60	4000	>80	11100	9570	160	5
	45130	STREET S MV 80 L AS CYCLO 4K	Asimmetrico ciclabile Asymmetric cycle line	80	4000	>80	14200	12320	154	5
	45133	STREET S MV 110 L AS CYCLO 4K	Asimmetrico ciclabile Asymmetric cycle line	110	4000	>80	18300	15851	144	5
	45142	STREET S MV 60 L AS PARK 4K	Asimmetrico Parking Asymmetric Parking	60	4000	>80	11100	9570	160	5
	45145	STREET S MV 80 L AS PARK 4K	Asimmetrico Parking Asymmetric Parking	80	4000	>80	14200	12320	154	5
	45148	STREET S MV 110 L AS PARK 4K	Asimmetrico Parking Asymmetric Parking	110	4000	>80	18300	15851	144	5
	45157	STREET S MV 60 L AS STRA 4K	Asimmetrico Stradale Asymmetric Urban street	60	4000	>80	11100	9570	160	5
	45160	STREET S MV 80 L AS STRA 4K	Asimmetrico Stradale Asymmetric Urban street	80	4000	>80	14200	12320	154	5
	45163	STREET S MV 110 L AS STRA 4K	Asimmetrico Stradale Asymmetric Urban street	110	4000	>80	18300	15851	144	5
	45172	STREET S MV 60 L SIM PARK 4K	Simmetrico Parking Symmetrical Parking	60	4000	>80	11100	9570	160	5
	45175	STREET S MV 80 L SIM PARK 4K	Simmetrico Parking Symmetrical Parking	80	4000	>80	14200	12320	154	5
	45178	STREET S MV 110 L SIM PARK 4K	Simmetrico Parking Symmetrical Parking	110	4000	>80	18300	15851	144	5
SD	45187	STREET S SDB 60 L AS CYCLO 4K	Asimmetrico ciclabile Asymmetric cycle line	60	4000	>80	11100	9570	160	5
	45190	STREET S SDB 80 L AS CYCLO 4K	Asimmetrico ciclabile Asymmetric cycle line	80	4000	>80	14200	12320	154	5
	45193	STREET S SDB 110 L AS CYCLO 4K	Asimmetrico ciclabile Asymmetric cycle line	110	4000	>80	18300	15851	144	5
	45202	STREET S SDB 60 L AS PARK 4K	Asimmetrico Parking Asymmetric Parking	60	4000	>80	11100	9570	160	5
	45205	STREET S SDB 80 L AS PARK 4K	Asimmetrico Parking Asymmetric Parking	80	4000	>80	14200	12320	154	5
	45208	STREET S SDB 110 L AS PARK 4K	Asimmetrico Parking Asymmetric Parking	110	4000	>80	18300	15851	144	5
	45217	STREET S SDB 60 L AS STRA 4K	Asimmetrico Stradale Asymmetric Urban street	60	4000	>80	11100	9570	160	5
	45220	STREET S SDB 80 L AS STRA 4K	Asimmetrico Stradale Asymmetric Urban street	80	4000	>80	14200	12320	154	5

ON-OFF

MEZZANOTTE VIRTUALE E INTERFACCIA DALI

BLUETOOTH

Cod.	Descrizione Description	Ottica Optics	Potenza Power W	Temp. colore Colour Temp. K	CRI	Flusso LED LED Flux lm (Tj=25°C)	Flusso Flux lm	Efficienza Efficiency lm/W	Kg
45223	STREET S SDB 110 L AS STRA 4K	Asimmetrico Stradale Asymmetric Urban street	110	4000	>80	18300	15851	144	5
45232	STREET S SDB 60 L SIM PARK 4K	Simmetrico Parking Symmetrical Parking	60	4000	>80	11100	9570	160	5
45235	STREET S SDB 80 L SIM PARK 4K	Simmetrico Parking Symmetrical Parking	80	4000	>80	14200	12320	154	5
45238	STREET S SDB 110 L SIM PARK 4K	Simmetrico Parking Symmetrical Parking	110	4000	>80	18300	15851	144	5

VARIANTI CON DIVERSA TEMPERATURA COLORE (K) / VERSIONS WITH DIFFERENT COLOUR TEMPERATURES (K)

Gli apparecchi sono disponibili anche in versione **3000K e 6000K**. L'elenco dei codici relativi è visionabile nell'**Indice analitico**, in calce ai codici su indicati con 4000K
The luminaires are also available in **3000K and 6000K** versions. A list of the related codes can be found in the **Analytical Index**, under the above codes with 4000K

EMERGENZA CON INVERTER LED - da ordinare separatamente EMERGENCY LED INVERTER - to be ordered separately



MODULO/MODULE TR - LG230 - LG24 - EPS

TR - Cod. **15069** (6W 1h)
LG24 - Cod. **15071** - versione SD / SD Version
LG230 - Cod. **15070** - versione SD / SD Version
LG EPS - Cod. **15072** - versione SD / SD Version

Versione con emergenza integrata tipo **TR** si ottiene sostituendo la Staffa di derivazione Modula con la versione opzionale **TR**.

TR emergency by replacing the Modula box bracket with the optional Modula box bracket TR version.

SD ACCESSORI - da ordinare separatamente / ACCESSORIES - to be ordered separately



CENTRALE LOGICA LOGICA CONTROL UNIT

SD LGFM - Cod. **21102**



MODULI RADIO RADIO MODULES

AUTODIMMER + RADIO - Cod. **15054**



CONCENTRATORE WIFI BLUETOOTH WIFI BLUETOOTH CONCENTRATOR

1 ingresso di controllo / 1 control input

Cod. **15064**



MODULO INTERFACCIA BLUETOOTH BLUETOOTH MODULE INTERFACE

3 ingressi di controllo / 3 control inputs

Cod. **15065**



CONCENTRATORE BLUETOOTH EASY BOX BLUETOOTH EASY BOX CONCENTRATOR

WiFi - Cod. **15174**
WiFi ETHERNET - Cod. **15074**



SENSORE PRESENZA MOTION SENSOR

INDUSTR IP65 - Cod. **15063**
UFFICI IP40 - Cod. **15062**

Sistema di trasmissione wireless integrato che permette la comunicazione fra gli apparecchi in modo da realizzare gruppi che attuano gli stessi comandi senza aggiungere ulteriori cablaggi. Utilizzando il Modulo interfaccia Bluetooth è possibile comandare i gruppi in modalità wireless. Per gestire un impianto centralizzato da APP B.connect occorre integrare il Concentratore Bluetooth.
Integrated wireless transmission system for communication between luminaires in order to create groups with the same commands without adding further wiring. Using the Bluetooth Interface Module it is possible to control the groups wireless. To manage a centralized system from the B.connect APP, the Bluetooth concentrator must be integrated.



IP66

IK09

960°

+40°C
-20°C

MEZZANOTTE VIRTUALE

Caratteristiche

Mantenimento flusso luminoso a 25°C

>70.000h (S70, S100, S150) (L80B20)

>75.000h (S30, S50) (L80B20)

Installazioni Testa palo o braccio $\Phi 60$ mm

Corpo Alluminio pressofuso verniciato alle polveri di poliestere RAL 7040

Ottica Lamellare a sviluppo parabolico in alluminio anodizzato brillantato anti-ridescente.

Schermo Vetro temprato spessore 5mm

Conformità EN 60598-1, EN 60598-2-3, EN 60598-2-22, EN 62471 (rischio fotobiologico esente), 2014/53/UE, EN60598-2-22

Applicazioni

Stradale pubblico e privato, parcheggi

Characteristics

Luminous flux retention at 25°C

>70,000h (S70, S100, S150) (L80B20)

>75,000h (S30, S50) (L80B20)

Mounting Pole or arm $\Phi 60$ mm

Housing Polyester powder-coated die-cast aluminium, RAL 7040

Optics Parabolic blades, made of anti-iridescent polished anodised aluminium.

Screen Tempered glass, 5mm thick

Compliance EN 60598-1, EN 60598-2-3, EN 60598-2-22, EN 62471 (photobiological-risk free), 2014/53/EU

Applications

Public and private roads, parking

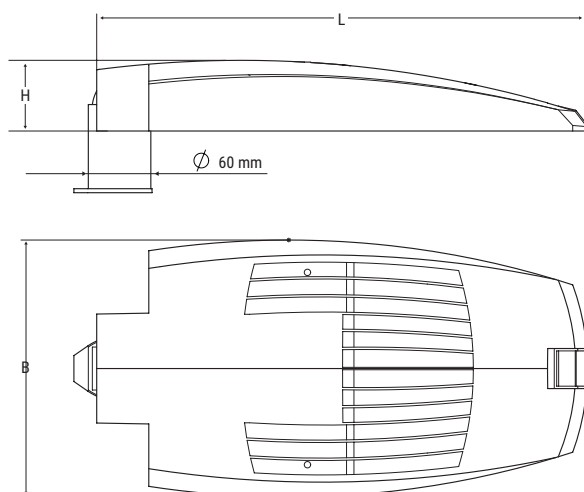

Dimensioni
Dimensions
mm

L	B	H	Ø
611	320	88	60

URBANA-EXTRAURBANA STRADALE
URBAN STREET OPTICS

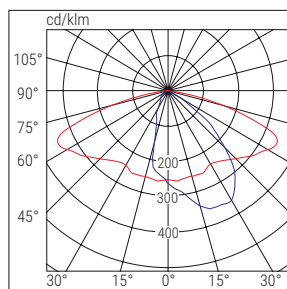

■ C0-C180 ■ C90-C270

URBANA/EXTRAURBANA A FASCIO LUNGO
LONG BEAM URBAN/EXTRA-URBAN OPTICS

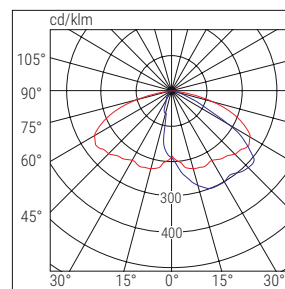

■ C0-C180 ■ C90-C270

URBANA CICLOPEDONALE/PARCHEGGI
URBAN CYCLING PATH / PARKING OPTICS

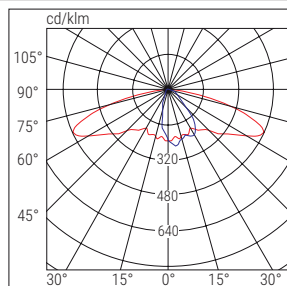

■ C0-C180 ■ C90-C270

CAMPI DI APPLICAZIONI DELLE OTTICHE

Strade extraurbane e strade urbane (ME2, ME3A, ME3B, ME4A, ME4B, ME5, ME6) e ciclopdonali (CE, S)

FIELDS OF OPTICS APPLICATION

Suburban and urban roads (ME2, ME3A, ME3B, ME4A, ME4B, ME5, ME6) and cycle paths (CE, S)

Cod.	Descrizione Description	Ottica Optics	Potenza Power W	Temp. colore Colour Temp. K	CRI	Flusso LED LED Flux lm (Tj=25°C)	Flusso Flux lm	Efficienza Efficiency lm/W	Kg
46030	STRADA LED DL/MV 35 R EX 4K	Stradale Extraurbana Extraurban street	34	4000	>70	5750	4750	140	5.5
46031	STRADA LED DL/MV 50 R EX 4K	Stradale Extraurbana Extraurban street	51	4000	>70	8000	7000	137	5.5
46032	STRADA LED DL/MV 70 R EX 4K	Stradale Extraurbana Extraurban street	66	4000	>70	12000	9950	135	5.5
46033	STRADA LED DL/MV 110 R EX 4K	Stradale Extraurbana Extraurban street	109	4000	>70	15850	13900	135	5.5
46034	STRADA LED DL/MV 130 R EX 4K	Stradale Extraurbana Extraurban street	130	4000	>70	20600	16900	130	5.5
46035	STRADA LED DL/MV 35 R EX L 4K	Stradal. Extraurb. F. Lungo Long range Extr.Urb Street	34	4000	>70	5750	4750	140	5.5
46036	STRADA LED DL/MV 50 R EX L 4K	Stradal. Extraurb. F. Lungo Long range Extr.Urb Street	51	4000	>70	8000	7000	137	5.5
46037	STRADA LED DL/MV 70 R EX L 4K	Stradal. Extraurb. F. Lungo Long range Extr.Urb Street	66	4000	>70	12000	9950	135	5.5
46038	STRADA LED DL/MV 110 R EX L 4K	Stradal. Extraurb. F. Lungo Long range Extr.Urb Street	109	4000	>70	15850	13900	135	5.5
46039	STRADA LED DL/MV 130 R EX L 4K	Stradal. Extraurb. F. Lungo Long range Extr.Urb Street	130	4000	>70	20600	16900	130	5.5
46040	STRADA LED DL/MV 25 R UC 4K	Urb. Cicloped/Park Urban Cycle/Ped/Park	24	4000	>70	4000	3300	138	5.5
46041	STRADA LED DL/MV 35 R UC 4K	Urb. Cicloped/Park Urban Cycle/Ped/Park	34	4000	>70	5750	4600	140	5.5
46042	STRADA LED DL/MV 50 R UC 4K	Urb. Cicloped/Park Urban Cycle/Ped/Park	51	4000	>70	8000	6500	137	5.5
46043	STRADA LED DL/MV 65 R UC 4K	Urb. Cicloped/Park Urban Cycle/Ped/Park	66	4000	>70	12000	8900	135	5.5

MEZZANOTTE VIRTUALE - DALI

MEZZANOTTE VIRTUALE E INTERFACCIA DALI

151 armature stradali / street lighting

Strada

Cod.	Descrizione Description	Ottica Optics	Potenza Power W	Temp. colore Colour Temp. K	CRI	Flusso LED LED Flux lm (Tj=25°C)	Flusso Flux lm	Efficienza Efficiency lm/W	Kg
46000	STRADA LED ZAGA 35 R EX 4K	Stradale Extraurbana Extrurban street	34	4000	>70	5750	4750	140	5.5
46001	STRADA LED ZAGA 50 R EX 4K	Stradale Extraurbana Extrurban street	51	4000	>70	8000	7000	137	5.5
46002	STRADA LED ZAGA 70 R EX 4K	Stradale Extraurbana Extrurban street	72	4000	>70	12500	9950	138	5.5
46003	STRADA LED ZAGA 110 R EX 4K	Stradale Extraurbana Extrurban street	109	4000	>70	15850	13900	135	5.5
46004	STRADA LED ZAGA 130 R EX 4K	Stradale Extraurbana Extrurban street	130	4000	>70	20600	16900	130	5.5
46005	STRADA LED ZAGA 35 R EX L 4K	Stradal. Extraurb. F. Lungo Long range Extr.Urb Street	34	4000	>70	5750	4750	140	5.5
46006	STRADA LED ZAGA 50 R EX L 4K	Stradal. Extraurb. F. Lungo Long range Extr.Urb Street	51	4000	>70	8000	7000	137	5.5
46007	STRADA LED ZAGA 70 R EX L 4K	Stradal. Extraurb. F. Lungo Long range Extr.Urb Street	66	4000	>70	12000	9950	135	5.5
46008	STRADA LED ZAGA 110 R EX L 4K	Stradal. Extraurb. F. Lungo Long range Extr.Urb Street	109	4000	>70	15850	13900	135	5.5
46009	STRADA LED ZAGA 130 R EX L 4K	Stradal. Extraurb. F. Lungo Long range Extr.Urb Street	130	4000	>70	20600	16900	130	5.5
46010	STRADA LED ZAGA 25 R UC 4K	Urb. Cicloped/Park Urban Cycle/Ped/Park	24	4000	>70	4000	3300	138	5.5
46011	STRADA LED ZAGA 35 R UC 4K	Urb. Cicloped/Park Urban Cycle/Ped/Park	34	4000	>70	5750	4600	140	5.5
46012	STRADA LED ZAGA 50 R UC 4K	Urb. Cicloped/Park Urban Cycle/Ped/Park	51	4000	>70	8000	6500	137	5.5
46013	STRADA LED ZAGA 65 R UC 4K	Urb. Cicloped/Park Urban Cycle/Ped/Park	66	4000	>70	12000	8900	135	5.5

VARIANTI CON DIVERSA TEMPERATURA COLORE (K) / VERSIONS WITH DIFFERENT COLOUR TEMPERATURES (K)

Gli apparecchi sono disponibili anche in versione **3000K**. L'elenco dei codici relativi è visionabile nell'**Indice analitico**, in calce ai codici su indicati con 4000K
 The luminaires are also available in **3000K** version. A list of the related codes can be found in the **Analytical Index**, under the above codes with 4000K

ACCESSORI - in dotazione / ACCESSORIES - included



**PRESSACAVO M20 CON VALVOLA
DI VENTILAZIONE**
**M20 CABLE GLAND WITH VENT
VALVE**

SD  **ACCESSORI** - da ordinare separatamente / **ACCESSORIES** - to be ordered separately



CENTRALE LOGICA
LOGICA CONTROL UNIT

SD LGFM - Cod. **21102**



CONCENTRATORE BLUETOOTH EASY BOX
BLUETOOTH EASY BOX CONCENTRATOR

WiFi - Cod. **15174**
WiFi ETHERNET - Cod. **15074**



CONCENTRATORE WIFI BLUETOOTH
WiFi BLUETOOTH CONCENTRATOR

1 ingresso di controllo / *1 control input*

Cod. **15064**



MODULO INTERFACCIA BLUETOOTH
BLUETOOTH MODULE INTERFACE

3 ingressi di controllo / *3 control inputs*

Cod. **15065**



SENSORE PRESENZA
MOTION SENSOR

INDUSTR IP65 - Cod. **15063**
UFFICI IP40 - Cod. **15062**

Sistema di trasmissione wireless integrato che permette la comunicazione fra gli apparecchi in modo da realizzare gruppi che attuano gli stessi comandi senza aggiungere ulteriori cablaggi. Utilizzando il Modulo interfaccia Bluetooth è possibile comandare i gruppi in modalità wireless. Per gestire un impianto centralizzato da APP B.connect occorre integrare il Concentratore Bluetooth. *Integrated wireless transmission system for communication between luminaires in order to create groups with the same commands without adding further wiring. Using the Bluetooth Interface Module it is possible to control the groups wireless. To manage a centralized system from the B.connect APP, the Bluetooth concentrator must be integrated.*





153 armature stradali / street lighting

Legenda simboli

CARATTERISTICHE GENERALI: SIGNIFICATO DEI SIMBOLI



















SIMBOLO	DESCRIZIONE
	Piattaforma cloud unica per la gestione remota di tutti gli impianti di illuminazione ed illuminazione di emergenza.
	Dispositivo gestibile direttamente da APP B.connect : consente la comunicazione ottica verso l'apparecchio e la connessione WiFi locale verso la centrale. Permette inoltre di accedere direttamente alla piattaforma NuBe Beghelli Cloud.
	Apparecchi dotati di Smart Driver SD-X, integrabili con vari moduli aggiuntivi che ne espandono le caratteristiche di comunicazione (Radio, 1-10V, Dali) oltre alla possibilità di connettere direttamente l'inverter Plug&Light, senza inficiare le caratteristiche di protezione. L'apparecchio con questo simbolo, è dotato di fotocellula intelligente integrata a bordo apparecchio con funzione Autodimmer.
	Apparecchi dotati di Smart Driver con Interfaccia SD radio integrata e già predisposta per comunicare con la centrale Logica SD LGFM. Questi apparecchi sono dotati anche di interfaccia 1-10V e, fotosensore intelligente con funzione Autodimmer.
	Apparecchi dotati di Smart Driver con trasmettitore Bluetooth integrato. Autodimmer ed interfaccia radio sono opzionali. Controllo locale via Bluetooth con App B.connect o centralizzato da Centrale di controllo Logica SD LGFM Concentratore Bluetooth.
	Apparecchi dotati di Smart Driver con trasmettitore Bluetooth e Autodimmer integrato ed interfaccia radio opzionale. Controllo locale via Bluetooth con App B.connect o centralizzato da Centrale di controllo Logica SD LGFM Concentratore Bluetooth.
	Apparecchi dotati di Smart Driver.
	Apparecchi dotati di Driver regolabile su 4 step di potenza per la modulazione del Flusso luminoso. Questi apparecchi sono dotati di switch per l'impostazione del flusso
	Apparecchi dotati di Driver LED tradizionale a luce fissa o dimmerabile 0-10V
	Apparecchi dotati di protocollo di comunicazione DALI.
	Dispositivo che integra l'apparecchio di illuminazione con l'illuminazione di emergenza, in versione tradizionale TR. Per approfondimenti consultare la sezione Emergenza
	Dispositivo che integra l'apparecchio di illuminazione con l'illuminazione di emergenza, in versione autotest AT. Per approfondimenti consultare la sezione Emergenza.
	Dispositivo che integra l'apparecchio di illuminazione con l'illuminazione di emergenza, in versione logica LG. Per approfondimenti consultare la sezione Emergenza.
	Dispositivo che integra l'apparecchio di illuminazione con l'illuminazione di emergenza, in versione logica radio LGFM. Per approfondimenti consultare la sezione Emergenza.

SIMBOLO	DESCRIZIONE
	Apparecchi con Box di derivazione integrato per facilitare il cablaggio e la manutenzione. Il Box può inoltre contenere uno o più slot per l'integrazione del Modulo radio e/o del Modulo emergenza.
	Apparecchi ibridi per illuminazione della serie SanificaAria che integrano un sistema di sanificazione dell'aria a cella di flusso UV-C.
	Apparecchio con modulo HCL-CCT, sia in versione SD che RD, per la variazione automatica della temperatura colore secondo l'ora della giornata (Illuminazione biodinamica), o per l'impostazione fissa selezionando da switch uno dei 4 valori preimpostati.
	Grado di protezione da fattori esterni secondo CEI EN 60598-1. Nel caso sia doppio, evidenzia due versioni dell'apparecchio o un accessorio opzionale specifico.
	Grado di protezione all'urto secondo CEI EN 50102.
	Temperatura di resistenza del l'apparecchio alla prova del Filo incandescente secondo CEI EN 60598-1.
	Apparecchi in cui la protezione contro la scossa elettrica è garantita per costruzione in Classe di Isolamento II.
	Campo di temperatura in cui l'apparecchio mantiene correttamente le sue caratteristiche.
	Indice di resa cromatica.
	Indice di resa abbagliamento.
	Apparecchio dotato di sensore di presenza.
	Apparecchio che integra l'inverter e la batteria per l'attivazione come illuminazione di emergenza.
	Marchio di qualità europea. Certificazione volontaria a testimoniare la qualità del prodotto e della filiera produttiva.
	Apparecchio destinato ad un utilizzo in ambienti con pericolo di esplosione per presenza di sostanze esplosive (polvere e/o gas...) secondo Direttiva ATEX .
	Apparecchi con assenza di effetto flicker visibile e a ridotto effetto stroboscopico. Le Norme CIE TN006:2016 f<80Hz e CIE TN006:2016 f<200Hz, definiscono valori limite e metodi di misura e non ammettono verifiche empiriche (fotocamera, smartphone, ecc). Gli effetti stroboscopici possono essere rilevati solo su organi in movimento. Ulteriori approfondimenti sul sito www.beghelli.it
	Apparecchio con modulo Led a CCT variabile, dotato di switch per selezionare uno dei 3 valori preimpostati per la variazione della temperatura colore K.
	Riduzione del flusso luminoso programmabile direttamente da quadro, in base all'orario notturno quando non occorre che l'apparecchio funzioni a piena potenza.
	Apparecchi con inverter e batteria integrati che assicurano 1h di autonomia all'illuminazione in caso di blackout
	Apparecchi dotati di regolazione della Potenza su 3 step di potenza. Nel retro è presente un apposito switch per la selezione.

Key to symbols

GENERAL CHARACTERISTICS: MEANING OF SYMBOLS

SYMBOL	DESCRIPTION
	Single cloud platform for the remote management of all lighting and emergency lighting systems.
	Control Unit or Luminaire manageable directly from the B.connect APP: it enables optical communications to the luminaire and local WiFi connections to the control unit. It also allows direct access to the NuBe cloud platform.
	Luminaires with an SD-X Smart Driver, which can be integrated with various additional modules that expand the communication features (Radio, 1-10V, Dali) as well as the possibility of directly connecting the Plug&Light inverter, without affecting the protection features. The luminaire with this symbol has an integrated smart photocell with Auto-dimmer function.
	Luminaires with Smart Driver with integrated SD radio interface and already prepared to communicate with the LGFM SD Logic Control Unit. These luminaires also have a 1-10V interface and a smart light sensor with Auto-dimmer function.
	Luminaires with Smart Driver equipped by Bluetooth transmitter. Autodimmer and radio interface are optional. Local control via Bluetooth with B.connect App or centralized from the Logica SD LGFM control unit or Bluetooth concentrator.
	Luminaires equipped with Smart Driver with Bluetooth transmitter and integrated Autodimmer and optional radio interface. Local control via Bluetooth with B.connect App or centralized from the Logica SD LGFM control unit or Bluetooth concentrator.
	Luminaires with Smart Driver.
	Luminaires with a driver adjustable in 4 power steps to modulate the luminous flux. These luminaires have flux setting switches.
	Luminaires with a 0=10V standard LED Driver with fixed or dimmable lighting.
	Luminaires with DALI communication protocol
	Device that integrates the luminaire with emergency lighting, in the standard TR version For more information, see the Emergency section
	Device that integrates the luminaire with emergency lighting, in the self-testing AT version. For more information, see the Emergency section.
	Device that integrates the luminaire with emergency lighting, in the Logica LG version. For more information, see the Emergency section.
	Device that integrates the luminaire with emergency lighting, in the LGFM Radio Logica version. For more information, see the Emergency section.

SYMBOL	DESCRIPTION
	Luminaires with integrated junction box to facilitate wiring and maintenance. The Box can also contain one or more slots for integrating the Radio Module and/or the Emergency Module.
	SanificaAria series hybrid luminaires incorporating a UV-C flow cell air sanitisation system.
	Luminaire with a HCL-CCT module, in both SD and RD versions, for automatic colour temperature variation according to the time of day (Biodynamic lighting), or fixed setting by selecting one of the 4 pre-set values from the switch.
	Protection rating against external factors according to EN 60598-1. Two ratings highlight two different versions/parts of the luminaire or a specific optional accessory.
	Protection rating against impact according to EN 50102.
	Resistance temperature of the luminaire at the Glow Wire Test according to IEC EN 60598-1.
	Luminaires in which protection against electric shock is guaranteed by an Insulation Class II built.
	General temperature range in which the luminaire maintains its characteristics correctly.
	Colour rendering index.
	Anti-glare index.
	Luminaire equipped with motion sensor.
	Luminaire with inverter and battery for activation as emergency lighting.
	European quality label. Voluntary certification to testify to the quality of the product and the production chain.
	Luminaire intended for use in areas where there is a risk of explosion due to the presence of explosive substances (dust and/or gas...) according to the ATEX Directive.
	Luminaires with no visible flicker and reduced stroboscopic effect. The CIE TN006:2016 f<80Hz and CIE TN006:2016 f<200Hz standards define limit values and measurement methods and do not allow empirical verifications (cameras, smartphones, etc.). Strobe effects can only be detected on moving parts. For more information, visit www.beghelli.it
	Luminaire with CCT adjustable, equipped with a switch to select one of the 3 preset values for color temperature.
	Luminous flux reduction programmable directly from the panel, based on the night time when the fixture does not need to operate at full power.
	Luminaires with inverter and battery that ensure 1h autonomy in the blackout event.
	Luminaires equipped with power regulation on 3 power steps. On the back there is a special switch for the selection.

Indice analitico

APPARECCHI / LUMINAIRES

Cod.	Descrizione	Pag.	Cod.	Descrizione	Pag.	Cod.	Descrizione	Pag.
40150	PAN RTI M600 25W U19C90 ED3K	14	40132	LENSPAN 418 M600 U19 C90 ED6K	21	70022	PAN LED 45W 600X600 4000K	25
40151	PAN RTI M600 25W U19C90 ED4K	14	40133	LENSPAN 236 30X120 U19C90 ED3K	21	70023	PAN LED 45W 1200X300 3000K	25
40152	PAN RTI M600 25W U19C90 ED6K	14	40134	LENSPAN 236 30X120 U19C90 ED4K	21	70024	PAN LED 45W 1200X300 4000K	25
40153	PAN RTI 30x120 25W U19C90 ED3K	14	40135	LENSPAN 236 30X120 U19C90 ED6K	21	70037	PAN LED 300X300 3000K	25
40154	PAN RTI 30x120 25W U19C90 ED4K	14	40136	LENSPAN 258 30X120 U19C90 ED3K	21	70038	PAN LED 300X300 4000K	25
40155	PAN RTI 30x120 25W U19C90 ED6K	14	40137	LENSPAN 258 30X120 U19C90 ED4K	21	70040	PAN LED 38W 60X60 UGR<19 3K	25
40156	PAN RTI 30x120 50W U19C90 ED3K	14	40138	LENSPAN 258 30X120 U19C90 ED6K	21	70041	PAN LED 38W 60X60 UGR<19 4K	25
40157	PAN RTI 30x120 50W U19C90 ED4K	14	40139	LENSPAN 418 M600 U19 C90 SD3K	21	70043	PAN LED 38W 120x30 UGR<19 4K	25
40158	PAN RTI 30x120 50W U19C90 ED6K	14	40140	LENSPAN 418 M600 U19 C90 SD4K	21	70044	PAN LED 45W 60X60 UGR<19 3K	25
40160	PAN RTI M600 35W U19C90 ED3K	14	40141	LENSPAN 418 M600 U19 C90 SD6K	21	70045	PAN LED 45W 60X60 UGR<19 4K	25
40161	PAN RTI M600 35W U19C90 ED4K	14	40142	LENSPAN 236 30X120 U19C90 SD3K	21	70046	PAN LED 45W 120X30 UGR<19 3K	25
40162	PAN RTI M600 35W U19C90 ED6K	14	40143	LENSPAN 236 30X120 U19C90 SD4K	21	70047	PAN LED 45W 120X30 UGR<19 4K	25
40163	PAN RTI 30x120 35W U19C90 ED3K	14	40144	LENSPAN 236 30X120 U19C90 SD6K	21	70080	BACKLIGHT LED 36W 600X600 3K	29
40164	PAN RTI 30x120 35W U19C90 ED4K	14	40145	LENSPAN 258 30X120 U19C90 SD3K	21	70081	BACKLIGHT LED 36W 600X600 4K	29
40165	PAN RTI 30x120 35W U19C90 ED6K	14	40146	LENSPAN 258 30X120 U19C90 SD4K	21	70082	BACKLIGHT LED 36W 30X120 3K	29
40166	PAN RTI M600 25W U19C90 HCL	14	40147	LENSPAN 258 30X120 U19C90 SD6K	21	70083	BACKLIGHT LED 36W 30X120 4K	29
40167	PAN RTI 30x120 25W U19C90 HCL	14	40130DL	LENSPAN 418 M600 U19 C90 DL3K	21	70084	BACKLIGHT UGR19 36W 600X600 3K	29
40170	PAN RTI M600 35W U19C90 SD3K	14	40131DL	LENSPAN 418 M600 U19 C90 DL4K	21	70085	BACKLIGHT UGR19 36W 600X600 4K	29
40171	PAN RTI M600 35W U19C90 SD4K	14	40132DL	LENSPAN 418 M600 U19 C90 DL6K	21	70086	BACKLIGHT UGR19 36W 30X120 3K	29
40172	PAN RTI M600 35W U19C90 SD6K	14	40133DL	LENSPAN 236 30X120 U19C90 DL3K	21	70087	BACKLIGHT UGR19 36W 30X120 4K	29
40173	PAN RTI 30x120 35W U19C90 SD3K	14	40134DL	LENSPAN 236 30X120 U19C90 DL4K	21	70088	BACKLIGHT LED 40W 600x600 3K	29
40174	PAN RTI 30x120 35W U19C90 SD4K	14	40135DL	LENSPAN 236 30X120 U19C90 DL6K	21	70089	BACKLIGHT LED 40W 600x600 4K	29
40175	PAN RTI 30x120 35W U19C90 SD6K	14	40136DL	LENSPAN 258 30X120 U19C90 DL3K	21	70090	BACKLIGHT UGR19 40W 600X600 3K	29
40180	PAN RTI 30x120 50W U19C90 SD3K	14	40137DL	LENSPAN 258 30X120 U19C90 DL4K	21	70091	BACKLIGHT UGR19 40W 600X600 4K	29
40181	PAN RTI 30x120 50W U19C90 SD4K	14	40138DL	LENSPAN 258 30X120 U19C90 DL6K	21	41131	CLINIC P M600 PM ED IP65 4K	31
40182	PAN RTI 30x120 50W U19C90 SD6K	14	40100	L PAN 418 M600 U19 C90 ED 3K	25	41134	CLINIC P M600 SG ED IP65 4K	31
40150DL	PAN RTI M600 25W U19C90 DL3K	14	40101	L PAN 418 M600 U19 C90 ED 4K	25	41137	CLINIC P PLAFO PM ED IP65 4K	31
40151DL	PAN RTI M600 25W U19C90 DL4K	14	40102	L PAN 418 M600 U19 C90 ED 6K	25	41140	CLINIC P PLAFO SG ED IP65 4K	31
40152DL	PAN RTI M600 25W U19C90 DL6K	14	40103	L PAN 30X120 U19 C90 ED 3K	25	41163	CLINIC M600 C90 PM ED IP65 4K	31
40153DL	PAN RTI 30x120 25W U19C90 DL3K	14	40104	L PAN 30X120 U19 C90 ED 4K	25	41166	CLINIC M600 C90 SG ED IP65 4K	31
40154DL	PAN RTI 30x120 25W U19C90 DL4K	14	40105	L PAN 30X120 U19 C90 ED 6K	25	41169	CLINIC PLAFO C90 PM ED IP65 4K	31
40155DL	PAN RTI 30x120 25W U19C90 DL6K	14	40106	L PAN 418 M600 U19 C90 SD 3K	25	41172	CLINIC PLAFO C90 SG ED IP65 4K	31
40156DL	PAN RTI 30x120 50W U19C90 DL3K	14	40107	L PAN 418 M600 U19 C90 SD 4K	25	41271	CLINIC P M600 PM SDB IP65 4K	31
40157DL	PAN RTI 30x120 50W U19C90 DL4K	14	40108	L PAN 418 M600 U19 C90 SD 6K	25	41274	CLINIC P M600 SG SDB IP65 4K	31
40158DL	PAN RTI 30x120 50W U19C90 DL6K	14	40109	L PAN 30X120 U19 C90 SD 3K	25	41277	CLINIC P PLAFO PM SDB IP65 4K	31
40160DL	PAN RTI M600 35W U19C90 DL3K	14	40110	L PAN 30X120 U19 C90 SD 4K	25	41280	CLINIC P PLAFO SG SDB IP65 4K	31
40161DL	PAN RTI M600 35W U19C90 DL4K	14	40111	L PAN 30X120 U19 C90 SD 6K	25	41283	CLINIC M600 C90 PM SDB IP65 4K	31
40162DL	PAN RTI M600 35W U19C90 DL6K	14	42301	LED PANEL 418 M600 U19 C90 SDB 4K	25	41286	CLINIC M600 C90 SG SDB IP65 4K	31
40163DL	PAN RTI 30x120 35W U19C90 DL3K	14	42304	LED PANEL 30X120 U19 C90 SDB 4K	25	41289	CLINIC PLAF C90 PM SDB IP65 4K	31
40164DL	PAN RTI 30x120 35W U19C90 DL4K	14	42313	LED PANEL 418 M600 U19 C90 DL 4K	25	41292	CLINIC PLAF C90 SG SDB IP65 4K	31
40165DL	PAN RTI 30x120 35W U19C90 DL6K	14	42316	LED PANEL 30X120 U19 C90 DL 4K	25	41501	CLINIC P M600 PM DL IP65 4K	31
26706	MODULO 600 SANIFICA ARIA	17	70010	PAN LED 38W 600X600 3000K	25	41504	CLINIC P M600 SG DL IP65 4K	31
40161UV	P RTI M600 35W U19C90 RD4K UV	17	70011	PAN LED 38W 600X600 4000K	25	41507	CLINIC P PLAFO PM DL IP65 4K	31
40171UV	P RTI M600 35W U19C90 SD4K UV	17	70012	PAN LED 38W 1200X300 3000K	25	41510	CLINIC P PLAFO SG DL IP65 4K	31
40130	LENSPAN 418 M600 U19 C90 ED3K	21	70013	PAN LED 38W 1200X300 4000K	25	41513	CLINIC M600 C90 PM DL IP65 4K	31
40131	LENSPAN 418 M600 U19 C90 ED4K	21	70021	PAN LED 45W 600X600 3000K	25	41516	CLINIC M600 C90 SG DL IP65 4K	31

Analytical index

APPARECCHI / LUMINAIRES

Cod.	Descrizione	Pag.	Cod.	Descrizione	Pag.	Cod.	Descrizione	Pag.
41519	CLINIC PLAFO C90 PM DL IP65 4K	31	74077	REGLED CCT 10W 873MM I	47	40389	DWL 24W 45° C90 BRILLA RD 4K	52
41522	CLINIC PLAFO C90 SG DL IP65 4K	31	74078	REGLED CCT 14W 1173MM I	47	40390	DWL 32W 45° C90 BRILLA RD 4K	52
42334	PLAFONE LED 2X36 SDB 4K C90	35	74079	REGLED CCT 18W 1473MM I	47	40391	DWL 41W 45° C90 BRILLA RD 4K	52
42335	PLAFONE LED 2X58 SDB 40K C90	35	74040	RGL P LED 4W 313MM 3000K I	49	40392	DWL 15W 45° C90 BRILLA DL 4K	52
42346	PLAFONE LED 2X36 DL 4K C90	35	74041	RGL P LED 4W 313MM 4000K I	49	40393	DWL 24W 45° C90 BRILLA DL 4K	52
42347	PLAFONE LED 2X58 DL 4K C90	35	74042	RGL P LED 8W 573MM 3000K I	49	40394	DWL 32W 45° C90 IP54 BR DL 4K	52
42358	PLAFONE LED 2X36 RD 4K C90	35	74043	RGL P LED 8W 573MM 4000K I	49	40395	DWL 41W 45° C90 IP54 BR DL 4K	52
42359	PLAFONE LED 2X58 RD 4K C90	35	74044	RGL P LED 10W 873MM 3000K I	49	40440	DWL 15W 45° C90 BRILLA RD 3K	52
75330	FULL MOON OPAL TUTTOSCH 18W 3K	39	74045	RGL P LED 10W 873MM 4000K I	49	40441	DWL 24W 45° C90 BRILLA RD 3K	52
75331	FULL MOON OPAL TUTTOSCH 18W 4K	39	74046	RGL P LED 14W 1173MM 3000K I	49	40442	DWL 32W 45° C90 BRILLA RD 3K	52
75332	FULL MOON OPAL TUTTOSCH 24W 3K	39	74047	RGL P LED 14W 1173MM 4000K I	49	40443	DWL 41W 45° C90 BRILLA RD 3K	52
75333	FULL MOON OPAL TUTTOSCH 24W 4K	39	74048	RGL P LED 18W 1473MM 3000K I	49	40444	DWL 15W 45° C90 IP54 BR DL 3K	52
75334	FULL MOON SENS TUTTOSCH 18W 3K	39	74049	RGL P LED 18W 1473MM 4000K I	49	40445	DWL 24W 45° C90 IP54 BR DL 3K	52
75335	FULL MOON SENS TUTTOSCH 18W 4K	39	40330	DWL 15W 75° C90 SAT RD 4K	51	40446	DWL 32W 45° C90 IP54 BR DL 3K	52
75336	FULL MOON SENS TUTTOSCH 24W 3K	39	40331	DWL 24W 75° C90 SAT RD 4K	51	40447	DWL 41W 45° C90 IP54 BR DL 3K	52
75337	FULL MOON SENS TUTTOSCH 24W 4K	39	40332	DWL 32W 75° C90 SAT RD 4K	51	40350	DWL 15W 75° C90 IP54 ST SDB 4K	53
75338	FULL MOON EM TUTTOSCH 18W 3K	39	40333	DWL 41W 75° C90 SAT RD 4K	51	40351	DWL 24W 75° C90 IP54 ST SDB 4K	53
75339	FULL MOON EM TUTTOSCH 18W 4K	39	40360	DWL 15W 75° C90 SAT RD 3K	51	40352	DWL 32W 75° C90 IP54 ST SDB 4K	53
75344	FULL MOON EM TUTTOSCH 24W 3K	39	40361	DWL 24W 75° C90 SAT RD 3K	51	40353	DWL 41W 75° C90 IP54 ST SDB 4K	53
75345	FULL MOON EM TUTTOSCH 24W 4K	39	40362	DWL 32W 75° C90 SAT RD 3K	51	40354	DWL 15W 75° C90 IP54 BI SDB 4K	53
75346	FULL MOON EMERG 3h 18W 3K	39	40363	DWL 41W 75° C90 SAT RD 3K	51	40355	DWL 24W 75° C90 IP54 BI SDB 4K	53
75347	FULL MOON EMERG 3h 18W 4K	39	40334	DWL 15W 75° C90 BIANCO RD 4K	52	40356	DWL 32W 75° C90 IP54 BI SDB 4K	53
75348	FULL MOON EMERG 3h 24W 3K	39	40335	DWL 24W 75° C90 BIANCO RD 4K	52	40357	DWL 41W 75° C90 IP54 BI SDB 4K	53
75349	FULL MOON EMERG 3h 24W 4K	39	40336	DWL 32W 75° C90 BIANCO RD 4K	52	40380	DWL 15W 75° C90 IP54 ST SDB 3K	53
75360	FULL MOON EMERG 3h SENS 18W 3K	39	40337	DWL 41W 75° C90 BIANCO RD 4K	52	40381	DWL 24W 75° C90 IP54 ST SDB 3K	53
75361	FULL MOON EMERG 3h SENS 18W 4K	39	40340	DWL 15W 75° C90 SAT DL 4K	52	40382	DWL 32W 75° C90 IP54 ST SDB 3K	53
75362	FULL MOON EMERG 3h SENS 24W 3K	39	40341	DWL 24W 75° C90 SAT DL 4K	52	40383	DWL 41W 75° C90 IP54 ST SDB 3K	53
75363	FULL MOON EMERG 3h SENS 24W 4K	39	40342	DWL 32W 75° C90 SAT DL 4K	52	40384	DWL 15W 75° C90 IP54 BI SDB 3K	53
75364	FULL MOON RING IP65 16W 4K	41	40343	DWL 41W 75° C90 SAT DL 4K	52	40385	DWL 24W 75° C90 IP54 BI SDB 3K	53
75365	FULL MOON RING IP65 26W 4K	41	40344	DWL 15W 75° C90 BIANCO DL 4K	52	40386	DWL 32W 75° C90 IP54 BI SDB 3K	53
75366	FULL MOON RING IP65 40W 4K	41	40345	DWL 24W 75° C90 BIANCO DL 4K	52	40387	DWL 41W 75° C90 IP54 BI SDB 3K	53
75320	GEO LED 15W ROUND WHITE 3K	43	40346	DWL 32W 75° C90 BIANCO DL 4K	52	40396	DWL 15W 45° C90 IP54 BR SDB 4K	53
75321	GEO LED 15W ROUND WHITE 4K	43	40347	DWL 41W 75° C90 BIANCO DL 4K	52	40397	DWL 24W 45° C90 IP54 BR SDB 4K	53
75322	GEO LED 20W ROUND WHITE 3K	43	40364	DWL 15W 75° C90 BIANCO RD 3K	52	40398	DWL 32W 45° C90 IP54 BR SDB 4K	53
75323	GEO LED 20W ROUND WHITE 4K	43	40365	DWL 24W 75° C90 BIANCO RD 3K	52	40399	DWL 41W 45° C90 IP54 BR SDB 4K	53
75324	GEO LED 15W ROUND BLACK 3K	43	40366	DWL 32W 75° C90 BIANCO RD 3K	52	40448	DWL 15W 45° C90 IP54 BR SDB 3K	53
75325	GEO LED 15W ROUND BLACK 4K	43	40367	DWL 41W 75° C90 BIANCO RD 3K	52	40449	DWL 24W 45° C90 IP54 BR SDB 3K	53
75327	GEO LED 20W ROUND BLACK 4K	43	40370	DWL 15W 75° C90 SAT DL 3K	52	40450	DWL 32W 45° C90 IP54 BR SDB 3K	53
75420	GEO LED 15W OVAL WHITE 3K	45	40371	DWL 24W 75° C90 SAT DL 3K	52	40451	DWL 41W 45° C90 IP54 BR SDB 3K	53
75421	GEO LED 15W OVAL WHITE 4K	45	40372	DWL 32W 75° C90 SAT DL 3K	52	71052	DWL LED 10W 3000K	57
75422	GEO LED 20W OVAL WHITE 3K	45	40373	DWL 41W 75° C90 SAT DL 3K	52	71053	DWL LED 10W 4000K	57
75423	GEO LED 20W OVAL WHITE 4K	45	40374	DWL 15W 75° C90 BIANCO DL 3K	52	71054	DWL LED 15W 3000K	57
75425	GEO LED 15W OVAL BLACK 4K	45	40375	DWL 24W 75° C90 BIANCO DL 3K	52	71055	DWL LED 15W 4000K	57
75427	GEO LED 20W OVAL BLACK 4K	45	40376	DWL 32W 75° C90 BIANCO DL 3K	52	71056	DWL LED 25W 3000K	57
74075	REGLED CCT 4W 313MM I	47	40377	DWL 41W 75° C90 BIANCO DL 3K	52	71057	DWL LED 25W 4000K	57
74076	REGLED CCT 8W 573MM I	47	40388	DWL 15W 45° C90 BRILLA RD 4K	52	71058	DWL LED 30W 3000K	57

Indice analitico

APPARECCHI / LUMINAIRES

Cod.	Descrizione	Pag.	Cod.	Descrizione	Pag.	Cod.	Descrizione	Pag.
71059	DWL LED 30W 4000K	57	40026	BS100 LED S670 SDB 5K	79	41231	ACCIAIO SDB L1500 6000K	83
71050	DWL LED 8W 3000K	59	40029	BS100 LED S670 SDB 6K	79	41232	ACCIAIO DALI S600 3000K	83
71051	DWL LED 8W 4000K	59	40021	BS100 LED M1280 SDB 3K	79	41233	ACCIAIO DALI S600 4000K	83
75350	ULTRATHIN DWL LED 12W 4000K	61	40024	BS100 LED M1280 SDB 4K	79	41234	ACCIAIO DALI S6005000K	83
75351	ULTRATHIN DWL LED 18W 4000K	61	40027	BS100 LED M1280 SDB 5K	79	41235	ACCIAIO DALI S600 6000K	83
75352	ULTRATHIN DWL LED 24W 4000K	61	40030	BS100 LED M1280 SDB 6K	79	41236	ACCIAIO DALI M1200 3000K	83
75353	ULTRATHIN DWL SQ LED 12W 4000K	63	40022	BS100 LED L1580 SDB 3K	79	41237	ACCIAIO DALI M1200 4000K	83
75354	ULTRATHIN DWL SQ LED 18W 4000K	63	40025	BS100 LED L1580 SDB 4K	79	41238	ACCIAIO DALI M1200 5000K	83
75355	ULTRATHIN DWL SQ LED 24W 4000K	63	40028	BS100 LED L1580 SDB 5K	79	41239	ACCIAIO DALI M1200 6000K	83
71064	X-SIX LED CCT REG MULTIPOWER S	65	40031	BS100 LED L1580 SDB 6K	79	41240	ACCIAIO DALI L1500 3000K	83
71065	X-SIX LED CCT REG MULTIPOWER M	65	40032	BS100 LEDPARK M1280 SDB 3K	79	41241	ACCIAIO DALI L1500 4000K	83
71062	X-SIX DWL LED CCT REG 18W	67	40033	BS100 LEDPARK M1280 SDB 4K	79	41242	ACCIAIO DALI L1500 5000K	83
71063	X-SIX DWL LED CCT REG 24W	67	40034	BS100 LEDPARK M1280 SDB 5K	79	41243	ACCIAIO DALI L1500 6000K	83
71060	X-SIX DOWNLIGHT LED CCT 20W	69	40035	BS100 LEDPARK M1280 SDB 6K	79	A218RD3	ACCIAIO REG 2X18W S600 3K	83
71066	X-SIX SQ LED CCT MULTIPOWER S	71	40040	BS100 LED S670 DALI 3K	79	A218RD	ACCIAIO REG 2X18W S600 4K	83
71067	X-SIX SQ LED CCT MULTIPOWER M	71	40043	BS100 LED S670 DALI 4K	79	A218RD6	ACCIAIO REG 2X18W S600 6K	83
71061	X-SIX SQ LED CCT 20W	73	40046	BS100 LED S670 DALI 5K	79	A236RD3	ACCIAIO REG 2X36W M1200 3K	83
41301	BS UNO MODULA RD 51W 3K	75	40049	BS100 LED S670 DALI 6K	79	A236RD	ACCIAIO REG 2X36W M1200 4K	83
41304	BS UNO MODULA RD 51W 4K	75	40041	BS100 LED M1280 DALI 3K	79	A236RD6	ACCIAIO REG 2X36W M1200 6K	83
41307	BS UNO MODULA RD 51W 6K	75	40044	BS100 LED M1280 DALI 4K	79	A258RD3	ACCIAIO REG 2X58W M1200 3K	83
41302	BS UNO MODULA RD 60W 3K	75	40047	BS100 LED M1280 DALI 5K	79	A258RD	ACCIAIO REG 2X58W M1200 4K	83
41305	BS UNO MODULA RD 60W 4K	75	40050	BS100 LED M1280 DALI 6K	79	A258RD6	ACCIAIO REG 2X58W M1200 6K	83
41303	BS UNO MODULA RD 72W 3K	75	40042	BS100 LED L1580 DALI 3K	79	A280RD3	ACCIAIO REG 2X80W L1500 3K	83
41308	BS UNO MODULA RD 60W 6K	75	40045	BS100 LED L1580 DALI 4K	79	A280RD	ACCIAIO REG 2X80W L1500 4K	83
41306	BS UNO MODULA RD 72W 4K	75	40048	BS100 LED L1580 DALI 5K	79	A280RD6	ACCIAIO REG 2X80W L1500 6K	83
41309	BS UNO MODULA RD 72W 6K	75	40051	BS100 LED L1580 DALI 6K	79	41250	ACCIAIO EX LED 2X36 SDB 3000K	87
41311	BS UNO MODULA DALI 51W 3K	75	40000H	BS100 LED REG HV S670 3K	79	41251	ACCIAIO EX LED 2X36 SDB 4000K	87
41314	BS UNO MODULA DALI 51W 4K	75	40003H	BS100 LED REG HV S670 4K	79	41252	ACCIAIO EX LED 2X36 SDB 6000K	87
41317	BS UNO MODULA DALI 51W 6K	75	40006H	BS100 LED REG HV S670 6K	79	41253	ACCIAIO EX LED 2X58 SDB 3000K	87
41312	BS UNO MODULA DALI 60W 3K	75	40001H	BS100 LED REG HV M1280 3K	79	41254	ACCIAIO EX LED 2X58 SDB 4000K	87
41315	BS UNO MODULA DALI 60W 4K	75	40004H	BS100 LED REG HV M1280 4K	79	41255	ACCIAIO EX LED 2X58 SDB 6000K	87
41318	BS UNO MODULA DALI 60W 6K	75	40007H	BS100 LED REG HV M1280 6K	79	41256	ACCIAIO EX LED 2X80 SDB 3000K	87
41313	BS UNO MODULA DALI 72W 3K	75	40002H	BS100 LED REG HV L1580 3K	79	41257	ACCIAIO EX LED 2X80 SDB 4000K	87
41316	BS UNO MODULA DALI 72W 4K	75	40005H	BS100 LED REG HV L1580 4K	79	41258	ACCIAIO EX LED 2X80 SDB 6000K	87
41319	BS UNO MODULA DALI 72W 6K	75	40008H	BS100 LED REG HV L1580 6K	79	41259	ACCIAIO EX LED 2X36 DALI 3000K	87
41321	BS UNO MODULA SDB 51W 3K	75	41220	ACCIAIO SDB S600 3000K	83	41260	ACCIAIO EX LED 2X36 DALI 4000K	87
41324	BS UNO MODULA SDB 51W 4K	75	41221	ACCIAIO SDB S600 4000K	83	41261	ACCIAIO EX LED 2X36 DALI 6000K	87
41327	BS UNO MODULA SDB 51W 6K	75	41222	ACCIAIO SDB S600 5000K	83	41262	ACCIAIO EX LED 2X58 DALI 3000K	87
41322	BS UNO MODULA SDB 60W 3K	75	41223	ACCIAIO SDB S600 6000K	83	41263	ACCIAIO EX LED 2X58 DALI 4000K	87
41325	BS UNO MODULA SDB 60W 4K	75	41224	ACCIAIO SDB M1200 3000K	83	41264	ACCIAIO EX LED 2X58 DALI 6000K	87
41328	BS UNO MODULA SDB 60W 6K	75	41225	ACCIAIO SDB M1200 4000K	83	41265	ACCIAIO EX LED 2X80 DALI 3000K	87
41323	BS UNO MODULA SDB 72W 3K	75	41226	ACCIAIO SDB M1200 5000K	83	41266	ACCIAIO EX LED 2X80 DALI 4000K	87
41326	BS UNO MODULA SDB 72W 4K	75	41227	ACCIAIO SDB M1200 6000K	83	41267	ACCIAIO EX LED 2X80 DALI 6000K	87
41329	BS UNO MODULA SDB 72W 6K	75	41228	ACCIAIO SDB L1500 3000K	83	72008	SAVING IP65 LED 236 3000K	91
40020	BS100 LED S670 SDB 3K	79	41229	ACCIAIO SDB L1500 4000K	83	72009	SAVING IP65 LED 258 3000K	91
40023	BS100 LED S670 SDB 4K	79	41230	ACCIAIO SDB L1500 5000K	83	72010	SAVING IP65 LED 236 4000K	91

Analytical index

APPARECCHI / LUMINAIRES

Cod.	Descrizione	Pag.	Cod.	Descrizione	Pag.	Cod.	Descrizione	Pag.
72011	SAVING IP65 LED 258 4000K	91	44040	HIGHBAY 2M SDB 300 R CONC 4K	102	40877	RIF S 150W C SDB 6K	105
72012	SAVING IP65 LED 236 6000K	91	44043	HIGHBAY 2M SDB 200 R EX DIF 4K	102	40878	RIF S 150W E SDB 3K	106
72013	SAVING IP65 LED 258 6000K	91	44046	HIGHBAY 2M SDB 300 R DIF 4K	102	40879	RIF S 150W E SDB 4K	106
72030	SAVING IP65 LED 218 3000K	91	44049	HIGHBAY 2M SDB 200 R ELL 4K	102	40880	RIF S 150W E SDB 6K	106
72031	SAVING IP65 LED 218 4000K	91	44052	HIGHBAY 2M SDB 300 R ELL 4K	102	40881	RIF S 240W D SDB 3K	106
72032	SAVING IP65 LED 218 6000K	91	40820	RIF S 150W D REGOLABILE 010 3K	105	40882	RIF S 240W D SDB 4K	106
72040	SAVING IP65 LED 258 GL 3000K	91	40821	RIF S 150W D REGOLABILE 010 4K	105	40883	RIF S 240W D SDB 6K	106
72041	SAVING IP65 LED 258 GL 4000K	91	40822	RIF S 150W D REGOLABILE 010 6K	105	40884	RIF S 240W C SDB 3K	106
72042	SAVING IP65 LED 258 GL 6000K	91	40823	RIF S 150W C REGOLABILE 010 3K	105	40885	RIF S 240W C SDB 4K	106
72001	SAVING IP65 TUBI LED 218 4000K	93	40824	RIF S 150W C REGOLABILE 010 4K	105	40886	RIF S 240W C SDB 6K	106
72002	SAVING IP65 TUBI LED 218 6500K	93	40825	RIF S 150W C REGOLABILE 010 6K	105	40887	RIF S 240W E SDB 3K	106
72003	SAVING IP65 TUBI LED 236 4000K	93	40826	RIF S 150W E REGOLABILE 010 3K	105	40888	RIF S 240W E SDB 4K	106
72004	SAVING IP65 TUBI LED 236 6500K	93	40827	RIF S 150W E REGOLABILE 010 4K	105	40889	RIF S 240W E SDB 6K	106
72005	SAVING IP65 TUBI LED 258 4000K	93	40828	RIF S 150W E REGOLABILE 010 6K	105	42370	BS240 LED 455 SDB 4000K CRI80	109
72006	SAVING IP65 TUBI LED 258 6500K	93	40829	RIF S 240W D REGOLABILE 010 3K	105	42371	BS240 LED 655 SDB 4000K CRI80	109
72015	SAVING IP65 TUBI LED 118 4000K	93	40830	RIF S 240W D REGOLABILE 010 4K	105	42372	BS240 LED PARKING SDB 4K CRI80	109
72016	SAVING IP65 TUBI LED 136 4000K	93	40831	RIF S 240W D REGOLABILE 010 6K	105	42374	BS240 LED 455 DL 4000K CRI80	109
72017	SAVING IP65 TUBI LED 158 4000K	93	40832	RIF S 240W C REGOLABILE 010 3K	105	42375	BS240 LED 655 DL 4000K CRI80	109
75463	SAVING SLIM 60 IP65 18W 4K	95	40833	RIF S 240W C REGOLABILE 010 4K	105	42376	BS240 LED PARKING DL 4K CRI80	109
75464	SAVING SLIM 120 IP65 38W 4K	95	40834	RIF S 240W C REGOLABILE 010 6K	105	42377	BS240 LED 455 REG HV 4K CRI80	109
75465	SAVING SLIM 150 IP65 58W 4K	95	40835	RIF S 240W E REGOLABILE 010 3K	105	42378	BS240 LED 655 REG HV 4K CRI80	109
75466	SAVING SLIM 60 IP65 18W 6.5K	95	40836	RIF S 240W E REGOLABILE 010 4K	105	42379	BS240 LED PARK REG HV 4K CRI80	109
75467	SAVING SLIM 120 IP65 38W 6.5K	95	40837	RIF S 240W E REGOLABILE 010 6K	105	40204	HIGHBAY HP 100W 90°0-10V 4K ED	113
75468	SAVING SLIM 150 IP65 58W 6.5K	95	40820DL	RIF S 150W D DALI 3K	105	40205	HIGHBAY HP 150W 90°0-10V 4K ED	113
75450	STAGNALED ES-600 15W 4K 1800LM	97	40821DL	RIF S 150W D DALI 4K	105	40206	HIGHBAY HP 200W 90°0-10V 4K ED	113
75451	STAGNALED ES-1200 30W 4K3600LM	97	40822DL	RIF S 150W D DALI 6K	105	40207	HIGHBAY HP 240W 90°0-10V 4K ED	113
75452	STAGNALED ES-1500 40W 4K4800LM	97	40823DL	RIF S 150W C DALI 3K	105	40224	HIGHBAY HP 100W 90° 4K SD SENS	113
75453	STAGNALED ES-600 15W6K5 1800LM	97	40824DL	RIF S 150W C DALI 4K	105	40225	HIGHBAY HP 150W 90° 4K SD SENS	113
75454	STAGNALED ES-1200 30W6K5 3600L	97	40825DL	RIF S 150W C DALI 6K	105	40226	HIGHBAY HP 200W 90° 4K SD SENS	113
75455	STAGNALED ES-1500 40W6K5 4800L	97	40826DL	RIF S 150W E DALI 3K	105	40227	HIGHBAY HP 240W 90° 4K SD SENS	113
75460	STAGNA EASY CCT IP65 60CM 20W	99	40827DL	RIF S 150W E DALI 4K	105	40240	HIGHBAY HP 100W 90° DALI 4K	113
75461	STAGNA EASY CCT IP65 120CM 40W	99	40828DL	RIF S 150W E DALI 6K	105	40241	HIGHBAY HP 150W 90° DALI 4K	113
75462	STAGNA EASY CCT IP65 150CM 55W	99	40829DL	RIF S 240W D DALI 3K	105	40242	HIGHBAY HP 200W 90° DALI 4K	113
44001	HIGHBAY 2M RD 200 R CONC 4K	102	40830DL	RIF S 240W D DALI 4K	105	40243	HIGHBAY HP 240W 90° DALI 4K	113
44004	HIGHBAY 2M RD 300 R CONC 4K	102	40831DL	RIF S 240W D DALI 6K	105	76305	HIGHBAY M.POWER 100/150/200W	115
44007	HIGHBAY 2M RD 200 R EX DIF 4K	102	40832DL	RIF S 240W C DALI 3K	105	43174	FLOOD S RD 80 L AS 3K	118
44010	HIGHBAY 2M RD 300 R DIF 4K	102	40833DL	RIF S 240W C DALI 4K	105	43175	FLOOD S RD 80 L AS 4K	118
44013	HIGHBAY 2M RD 200 R ELL 4K	102	40834DL	RIF S 240W C DALI 6K	105	43176	FLOOD S RD 80 L AS 6K	118
44016	HIGHBAY 2M RD 300 R ELL 4K	102	40835DL	RIF S 240W E DALI 3K	105	43177	FLOOD S RD 125 L AS 3K	118
44019	HIGHBAY 2M DALI 200 R CONC 4K	102	40836DL	RIF S 240W E DALI 4K	105	43178	FLOOD S RD 125 L AS 4K	118
44022	HIGHBAY 2M DALI 300 R CONC 4K	102	40837DL	RIF S 240W E DALI 6K	105	43179	FLOOD S RD 125 L AS 6K	118
44025	HIGHBAY 2M DL 200 R EX DIF 4K	102	40872	RIF S 150W D SDB 3K	105	43183	FLOOD S RD 80 L PADEL 3K	118
44028	HIGHBAY 2M DALI 300 R DIF 4K	102	40873	RIF S 150W D SDB 4K	105	43184	FLOOD S RD 80 L PADEL 4K	118
44031	HIGHBAY 2M DALI 200 R ELL 4K	102	40874	RIF S 150W D SDB 6K	105	43185	FLOOD S RD 80 L PADEL 6K	118
44034	HIGHBAY 2M DALI 300 R ELL 4K	102	40875	RIF S 150W C SDB 3K	105	43186	FLOOD S RD 125 L PADEL 3K	118
44037	HIGHBAY 2M SDB 200 R CONC 4K	102	40876	RIF S 150W C SDB 4K	105	43187	FLOOD S RD 125 L PADEL 4K	118

Indice analitico

APPARECCHI / LUMINAIRES

Cod.	Descrizione	Pag.	Cod.	Descrizione	Pag.	Cod.	Descrizione	Pag.
43188	FLOOD S RD 125 L PADEL 6K	118	43258	FLOOD S DALI 95 L CONC 3K	119	43325	FLOOD S SDB 95 L CONC 4K	119
43192	FLOOD S RD 80 L CONC 3K	118	43259	FLOOD S DALI 95 L CONC 4K	119	43326	FLOOD S SDB 95 L CONC 6K	119
43193	FLOOD S RD 80 L CONC 4K	118	43260	FLOOD S DALI 95 L CONC 6K	119	43327	FLOOD S SDB 125 L CONC 3K	119
43194	FLOOD S RD 80 L CONC 6K	118	43261	FLOOD S DALI 125 L CONC 3K	119	43328	FLOOD S SDB 125 L CONC 4K	119
43195	FLOOD S RD 125 L CONC 3K	118	43262	FLOOD S DALI 125 L CONC 4K	119	43329	FLOOD S SDB 125 L CONC 6K	119
43196	FLOOD S RD 125 L CONC 4K	118	43263	FLOOD S DALI 125 L CONC 6K	119	43333	FLOOD S SDB 95 L DIF 3K	119
43197	FLOOD S RD 125 L CONC 6K	118	43267	FLOOD S DALI 95 L DIF 3K	119	43334	FLOOD S SDB 95 L DIF 4K	119
43201	FLOOD S RD 80 L DIF 3K	118	43268	FLOOD S DALI 95 L DIF 4K	119	43335	FLOOD S SDB 95 L DIF 6K	119
43202	FLOOD S RD 80 L DIF 4K	118	43269	FLOOD S DALI 95 L DIF 6K	119	43336	FLOOD S SDB 125 L DIF 3K	119
43203	FLOOD S RD 80 L DIF 6K	118	43270	FLOOD S DALI 125 L DIF 3K	119	43337	FLOOD S SDB 125 L DIF 4K	119
43204	FLOOD S RD 125 L DIF 3K	118	43271	FLOOD S DALI 125 L DIF 4K	119	43338	FLOOD S SDB 125 L DIF 6K	119
43205	FLOOD S RD 125 L DIF 4K	118	43272	FLOOD S DALI 125 L DIF 6K	119	43342	FLOOD S SDB 80 R AS 3K	119
43206	FLOOD S RD 125 L DIF 6K	118	43276	FLOOD S DALI 80 R AS 3K	119	43343	FLOOD S SDB 80 R AS 4K	119
43210	FLOOD S RD 80 R AS 3K	118	43277	FLOOD S DALI 80 R AS 4K	119	43344	FLOOD S SDB 80 R AS 6K	119
43211	FLOOD S RD 80 R AS 4K	118	43278	FLOOD S DALI 80 R AS 6K	119	43345	FLOOD S SDB 100 R AS 3K	119
43212	FLOOD S RD 80 R AS 6K	118	43279	FLOOD S DALI 100 R AS 3K	119	43346	FLOOD S SDB 100 R AS 4K	119
43213	FLOOD S RD 100 R AS 3K	118	43280	FLOOD S DALI 100 R AS 4K	119	43347	FLOOD S SDB 100 R AS 6K	119
43214	FLOOD S RD 100 R AS 4K	118	43281	FLOOD S DALI 100 R AS 6K	119	43348	FLOOD S SDB 120 R AS 3K	119
43215	FLOOD S RD 100 R AS 6K	118	43282	FLOOD S DALI 120 R AS 3K	119	43349	FLOOD S SDB 120 R AS 4K	119
43216	FLOOD S RD 120 R AS 3K	118	43283	FLOOD S DALI 120 R AS 4K	119	43350	FLOOD S SDB 120 R AS 6K	119
43217	FLOOD S RD 120 R AS 4K	118	43284	FLOOD S DALI 120 R AS 6K	119	43354	FLOOD S SDB 95 R CONC 3K	119
43218	FLOOD S RD 120 R AS 6K	118	43288	FLOOD S DALI 95 R CONC 3K	119	43355	FLOOD S SDB 95 R CONC 4K	119
43222	FLOOD S RD 80 R CONC 3K	118	43289	FLOOD S DALI 95 R CONC 4K	119	43356	FLOOD S SDB 95 R CONC 6K	119
43223	FLOOD S RD 80 R CONC 4K	118	43290	FLOOD S DALI 95 R CONC 6K	119	43357	FLOOD S SDB 125 R CONC 3K	119
43224	FLOOD S RD 80 R CONC 6K	118	43291	FLOOD S DALI 125 R CONC 3K	119	43358	FLOOD S SDB 125 R CONC 4K	119
43225	FLOOD S RD 125 R CONC 3K	118	43292	FLOOD S DALI 125 R CONC 4K	119	43359	FLOOD S SDB 125 R CONC 6K	119
43226	FLOOD S RD 125 R CONC 4K	118	43293	FLOOD S DALI 125 R CONC 6K	119	43363	FLOOD S SDB 95 R DIF 3K	119
43227	FLOOD S RD 125 R CONC 6K	118	43297	FLOOD S DALI 95 R DIF 3K	119	43364	FLOOD S SDB 95 R DIF 4K	119
43231	FLOOD S RD 80 R DIF 3K	118	43298	FLOOD S DALI 95 R DIF 4K	119	43365	FLOOD S SDB 95 R DIF 6K	119
43232	FLOOD S RD 80 R DIF 4K	118	43299	FLOOD S DALI 95 R DIF 6K	119	43366	FLOOD S SDB 125 R DIF 3K	119
43233	FLOOD S RD 80 R DIF 6K	118	43300	FLOOD S DALI 125 R DIF 3K	119	43367	FLOOD S SDB 125 R DIF 4K	119
43234	FLOOD S RD 125 R DIF 3K	118	43301	FLOOD S DALI 125 R DIF 4K	119	43368	FLOOD S SDB 125 R DIF 6K	119
43235	FLOOD S RD 125 R DIF 4K	118	43302	FLOOD S DALI 125 R DIF 6K	119	43000	FLOOD M RD 150 L AS 3K	124
43236	FLOOD S RD 125 R DIF 6K	118	43306	FLOOD S SDB 95 L AS 3K	119	43001	FLOOD M RD 150 L AS 4K	124
43240	FLOOD S DALI 95 L AS 3K	119	43307	FLOOD S SDB 95 L AS 4K	119	43002	FLOOD M RD 150 L AS 6K	124
43241	FLOOD S DALI 95 L AS 4K	119	43308	FLOOD S SDB 95 L AS 6K	119	43003	FLOOD M RD 210 L AS 3K	124
43242	FLOOD S DALI 95 L AS 6K	119	43309	FLOOD S SDB 125 L AS 3K	119	43004	FLOOD M RD 210 L AS 4K	124
43243	FLOOD S DALI 125 L AS 3K	119	43310	FLOOD S SDB 125 L AS 4K	119	43005	FLOOD M RD 210 L AS 6K	124
43244	FLOOD S DALI 125 L AS 4K	119	43311	FLOOD S SDB 125 L AS 6K	119	43006	FLOOD M RD 150 L PADEL 3K	124
43245	FLOOD S DALI 125 L AS 6K	119	43315	FLOOD S SDB 95 L PADEL 3K	119	43007	FLOOD M RD 150 L PADEL 4K	124
43249	FLOOD S DALI 95 L PADEL 3K	119	43316	FLOOD S SDB 95 L PADEL 4K	119	43008	FLOOD M RD 150 L PADEL 6K	124
43250	FLOOD S DALI 95 L PADEL 4K	119	43317	FLOOD S SDB 95 L PADEL 6K	119	43009	FLOOD M RD 210 L PADEL 3K	124
43251	FLOOD S DALI 95 L PADEL 6K	119	43318	FLOOD S SDB 125 L PADEL 3K	119	43010	FLOOD M RD 210 L PADEL 4K	124
43252	FLOOD S DALI 125 L PADEL 3K	119	43319	FLOOD S SDB 125 L PADEL 4K	119	43011	FLOOD M RD 210 L PADEL 6K	124
43253	FLOOD S DALI 125 L PADEL 4K	119	43320	FLOOD S SDB 125 L PADEL 6K	119	43012	FLOOD M RD 150 L CONC 3K	124
43254	FLOOD S DALI 125 L PADEL 6K	119	43324	FLOOD S SDB 95 L CONC 3K	119	43013	FLOOD M RD 150 L CONC 4K	124

Analytical index

APPARECCHI / LUMINAIRES

Cod.	Descrizione	Pag.	Cod.	Descrizione	Pag.	Cod.	Descrizione	Pag.
43014	FLOOD M RD 150 L CONC 6K	124	43060	FLOOD M DALI 230 L PADEL 3K	124	43106	FLOOD M DALI 230 R DIF 4K	125
43015	FLOOD M RD 210 L CONC 3K	124	43061	FLOOD M DALI 230 L PADEL 4K	124	43107	FLOOD M DALI 230 R DIF 6K	125
43016	FLOOD M RD 210 L CONC 4K	124	43062	FLOOD M DALI 230 L PADEL 6K	124	43108	FLOOD M SDB 145 L AS 3K	125
43017	FLOOD M RD 210 L CONC 6K	124	43063	FLOOD M DALI 145 L CONC 3K	124	43109	FLOOD M SDB 145 L AS 4K	125
43018	FLOOD M RD 150 L DIF 3K	124	43064	FLOOD M DALI 145 L CONC 4K	124	43110	FLOOD M SDB 145 L AS 6K	125
43019	FLOOD M RD 150 L DIF 4K	124	43065	FLOOD M DALI 145 L CONC 6K	124	43111	FLOOD M SDB 190 L AS 3K	125
43020	FLOOD M RD 150 L DIF 6K	124	43066	FLOOD M DALI 190 L CONC 3K	124	43112	FLOOD M SDB 190 L AS 4K	125
43021	FLOOD M RD 210 L DIF 3K	124	43067	FLOOD M DALI 190 L CONC 4K	124	43113	FLOOD M SDB 190 L AS 6K	125
43022	FLOOD M RD 210 L DIF 4K	124	43068	FLOOD M DALI 190 L CONC 6K	124	43114	FLOOD M SDB 230 L AS 3K	125
43023	FLOOD M RD 210 L DIF 6K	124	43069	FLOOD M DALI 230 L CONC 3K	125	43115	FLOOD M SDB 230 L AS 4K	125
43024	FLOOD M RD 145 R AS 3K	124	43070	FLOOD M DALI 230 L CONC 4K	125	43116	FLOOD M SDB 230 L AS 6K	125
43025	FLOOD M RD 145 R AS 4K	124	43071	FLOOD M DALI 230 L CONC 6K	125	43117	FLOOD M SDB 145 L PADEL 3K	125
43026	FLOOD M RD 145 R AS 6K	124	43072	FLOOD M DALI 145 L DIF 3K	125	43118	FLOOD M SDB 145 L PADEL 4K	125
43027	FLOOD M RD 180 R AS 3K	124	43073	FLOOD M DALI 145 L DIF 4K	125	43119	FLOOD M SDB 145 L PADEL 6K	125
43028	FLOOD M RD 180 R AS 4K	124	43074	FLOOD M DALI 145 L DIF 6K	125	43120	FLOOD M SDB 190 L PADEL 3K	125
43029	FLOOD M RD 180 R AS 6K	124	43075	FLOOD M DALI 190 L DIF 3K	125	43121	FLOOD M SDB 190 L PADEL 4K	125
43030	FLOOD M RD 210 R AS 3K	124	43076	FLOOD M DALI 190 L DIF 4K	125	43122	FLOOD M SDB 190 L PADEL 6K	125
43031	FLOOD M RD 210 R AS 4K	124	43077	FLOOD M DALI 190 L DIF 6K	125	43123	FLOOD M SDB 230 L PADEL 3K	125
43032	FLOOD M RD 210 R AS 6K	124	43078	FLOOD M DALI 230 L DIF 3K	125	43124	FLOOD M SDB 230 L PADEL 4K	125
43033	FLOOD M RD 150 R CONC 3K	124	43079	FLOOD M DALI 230 L DIF 4K	125	43125	FLOOD M SDB 230 L PADEL 6K	125
43034	FLOOD M RD 150 R CONC 4K	124	43080	FLOOD M DALI 230 L DIF 6K	125	43126	FLOOD M SDB 145 L CONC 3K	125
43035	FLOOD M RD 150 R CONC 6K	124	43081	FLOOD M DALI 145 R AS 3K	125	43127	FLOOD M SDB 145 L CONC 4K	125
43036	FLOOD M RD 210 R CONC 3K	124	43082	FLOOD M DALI 145 R AS 4K	125	43128	FLOOD M SDB 145 L CONC 6K	125
43037	FLOOD M RD 210 R CONC 4K	124	43083	FLOOD M DALI 145 R AS 6K	125	43129	FLOOD M SDB 190 L CONC 3K	125
43038	FLOOD M RD 210 R CONC 6K	124	43084	FLOOD M DALI 180 R AS 3K	125	43130	FLOOD M SDB 190 L CONC 4K	125
43039	FLOOD M RD 150 R DIF 3K	124	43085	FLOOD M DALI 180 R AS 4K	125	43131	FLOOD M SDB 190 L CONC 6K	125
43040	FLOOD M RD 150 R DIF 4K	124	43086	FLOOD M DALI 180 R AS 6K	125	43132	FLOOD M SDB 230 L CONC 3K	125
43041	FLOOD M RD 150 R DIF 6K	124	43087	FLOOD M DALI 230 R AS 3K	125	43133	FLOOD M SDB 230 L CONC 4K	125
43042	FLOOD M RD 210 R DIF 3K	124	43088	FLOOD M DALI 230 R AS 4K	125	43134	FLOOD M SDB 230 L CONC 6K	125
43043	FLOOD M RD 210 R DIF 4K	124	43089	FLOOD M DALI 230 R AS 6K	125	43135	FLOOD M SDB 145 L DIF 3K	125
43044	FLOOD M RD 210 R DIF 6K	124	43090	FLOOD M DALI 145 R CONC 3K	125	43136	FLOOD M SDB 145 L DIF 4K	125
43045	FLOOD M DALI 145 L AS 3K	124	43091	FLOOD M DALI 145 R CONC 4K	125	43137	FLOOD M SDB 145 L DIF 6K	125
43046	FLOOD M DALI 145 L AS 4K	124	43092	FLOOD M DALI 145 R CONC 6K	125	43138	FLOOD M SDB 190 L DIF 3K	125
43047	FLOOD M DALI 145 L AS 6K	124	43093	FLOOD M DALI 190 R CONC 3K	125	43139	FLOOD M SDB 190 L DIF 4K	125
43048	FLOOD M DALI 190 L AS 3K	124	43094	FLOOD M DALI 190 R CONC 4K	125	43140	FLOOD M SDB 190 L DIF 6K	125
43049	FLOOD M DALI 190 L AS 4K	124	43095	FLOOD M DALI 190 R CONC 6K	125	43141	FLOOD M SDB 230 L DIF 3K	125
43050	FLOOD M DALI 190 L AS 6K	124	43096	FLOOD M DALI 230 R CONC 3K	125	43142	FLOOD M SDB 230 L DIF 4K	125
43051	FLOOD M DALI 230 L AS 3K	124	43097	FLOOD M DALI 230 R CONC 4K	125	43143	FLOOD M SDB 230 L DIF 6K	125
43052	FLOOD M DALI 230 L AS 4K	124	43098	FLOOD M DALI 230 R CONC 6K	125	43144	FLOOD M SDB 145 R AS 3K	125
43053	FLOOD M DALI 230 L AS 6K	124	43099	FLOOD M DALI 145 R DIF 3K	125	43145	FLOOD M SDB 145 R AS 4K	125
43054	FLOOD M DALI 145 L PADEL 3K	124	43100	FLOOD M DALI 145 R DIF 4K	125	43146	FLOOD M SDB 145 R AS 6K	125
43055	FLOOD M DALI 145 L PADEL 4K	124	43101	FLOOD M DALI 145 R DIF 6K	125	43147	FLOOD M SDB 180 R AS 3K	125
43056	FLOOD M DALI 145 L PADEL 6K	124	43102	FLOOD M DALI 190 R DIF 3K	125	43148	FLOOD M SDB 180 R AS 4K	125
43057	FLOOD M DALI 190 L PADEL 3K	124	43103	FLOOD M DALI 190 R DIF 4K	125	43149	FLOOD M SDB 180 R AS 6K	125
43058	FLOOD M DALI 190 L PADEL 4K	124	43104	FLOOD M DALI 190 R DIF 6K	125	43150	FLOOD M SDB 230 R AS 3K	125
43059	FLOOD M DALI 190 L PADEL 6K	124	43105	FLOOD M DALI 230 R DIF 3K	125	43151	FLOOD M SDB 230 R AS 4K	125

Indice analitico

APPARECCHI / LUMINAIRES

Cod.	Descrizione	Pag.	Cod.	Descrizione	Pag.	Cod.	Descrizione	Pag.
43152	FLOOD M SDB 230 R AS 6K	125	86181	FL LED 30W WHITE IP66 SENS 4K	130	41400	POWER L DALI 300W C70 5k 30°	144
43153	FLOOD M SDB 145 R CONC 3K	125	86182	FL LED 10W NERO IP66 SENS 4K	130	41401	POWER L DALI 600W C70 5k 30°	144
43154	FLOOD M SDB 145 R CONC 4K	125	86183	FL LED 30W NERO IP66 SENS 4K	130	41402	POWER L DALI 900W C70 5k 30°	144
43155	FLOOD M SDB 145 R CONC 6K	125	86173	FL LED 100W NERO IP66 3K	131	41403	POWER L DALI 1200W C70 5k 30°	144
43156	FLOOD M SDB 190 R CONC 3K	125	86174	FL LED 100W NERO IP66 4K	131	41404	POWER L DALI 300W C70 5k 60°	144
43157	FLOOD M SDB 190 R CONC 4K	125	86176	FL LED 200W NERO IP66 3K	131	41405	POWER L DALI 600W C70 5k 60°	144
43158	FLOOD M SDB 190 R CONC 6K	125	86177	FL LED 200W NERO IP66 4K	131	41406	POWER L DALI 900W C70 5k 60°	144
43159	FLOOD M SDB 230 R CONC 3K	125	F30LED	PRO LED 1X30 4K	133	41407	POWER L DALI 1200W C70 5k 60°	144
43160	FLOOD M SDB 230 R CONC 4K	125	F50LED	PRO LED 1X50 4K	133	41408	POWER L DALI 300W C70 5k ASY	144
43161	FLOOD M SDB 230 R CONC 6K	125	F70LED	PRO LED 1X70 4K	133	41409	POWER L DALI 600W C70 5k ASY	144
43162	FLOOD M SDB 145 R DIF 3K	125	40800	PRO/RIF 50W REGOLABILE 3K	135	41410	POWER L DALI 900W C70 5k ASY	144
43163	FLOOD M SDB 145 R DIF 4K	125	40801	PRO/RIF 50W REGOLABILE 4K	135	41411	POWER L DALI 1200W C70 5k ASY	144
43164	FLOOD M SDB 145 R DIF 6K	125	40802	PRO/RIF 50W REGOLABILE 6K	135	41412	POWER L SDB 300W C70 5k 30°	144
43165	FLOOD M SDB 190 R DIF 3K	125	40803	PRO/RIF 100W REGOLABILE 3K	135	41413	POWER L SDB 600W C70 5k 30°	144
43166	FLOOD M SDB 190 R DIF 4K	125	40804	PRO/RIF 100W REGOLABILE 4K	135	41414	POWER L SDB 900W C70 5k 30°	144
43167	FLOOD M SDB 190 R DIF 6K	125	40805	PRO/RIF 100W REGOLABILE 6K	135	41415	POWER L SDB 1200W C70 5k 30°	144
43168	FLOOD M SDB 230 R DIF 3K	125	40800DL	PRO/RIF 75W DALI 3K	135	41416	POWER L SDB 300W C70 5k 60°	144
43169	FLOOD M SDB 230 R DIF 4K	125	40801DL	PRO/RIF 75W DALI 4K	135	41417	POWER L SDB 600W C70 5k 60°	144
43170	FLOOD M SDB 230 R DIF 6K	125	40802DL	PRO/RIF 75W DALI 6K	135	41418	POWER L SDB 900W C70 5k 60°	144
86145	FL LED 10W BIANCO IP66 3K	130	40803DL	PRO/RIF 100W DALI 3K	135	41419	POWER L SDB 1200W C70 5k 60°	144
86146	FL LED 20W BIANCO IP66 3K	130	40804DL	PRO/RIF 100W DALI 4K	135	41420	POWER L SDB 300W C70 5k ASY	144
86147	FL LED 30W BIANCO IP66 3K	130	40805DL	PRO/RIF 100W DALI 6K	135	41421	POWER L SDB 600W C70 5k ASY	144
86148	FL LED 50W BIANCO IP66 3K	130	40940	PRO/RIF 75W SD DALI 3K	135	41422	POWER L SDB 900W C70 5k ASY	144
86149	FL LED 10W BIANCO IP66 4K	130	40941	PRO/RIF 75W SD DALI 4K	135	41423	POWER L SDB 1200W C70 5k ASY	144
86150	FL LED 20W BIANCO IP66 4K	130	40942	PRO/RIF 75W SD DALI 6K	135	41424	POWER L DALI 300W C70 5k 10°	144
86151	FL LED 30W BIANCO IP66 4K	130	40943	PRO/RIF 100W SD DALI 3K	135	41425	POWER L DALI 600W C70 5k 10°	144
86152	FL LED 50W BIANCO IP66 4K	130	40944	PRO/RIF 100W SD DALI 4K	135	41426	POWER L DALI 900W C70 5k 10°	144
86153	FL LED 20W BIANCO IP66 6K5	130	40945	PRO/RIF 100W SD DALI 6K	135	41427	POWER L DALI 1200W C70 5k 10°	144
86154	FL LED 30W BIANCO IP66 6K5	130	40860	PRO/RIF 150W REGOLABILE 3K	139	41428	POWER L SDB 300W C70 5k 10°	144
86156	FL LED 10W NERO IP66 3K	130	40861	PRO/RIF 150W REGOLABILE 4K	139	41429	POWER L SDB 600W C70 5k 10°	144
86157	FL LED 20W NERO IP66 3K	130	40862	PRO/RIF 150W REGOLABILE 6K	139	41430	POWER L SDB 900W C70 5k 10°	144
86158	FL LED 30W NERO IP66 3K	130	40863	PRO/RIF 200W REGOLABILE 3K	139	41431	POWER L SDB 1200W C70 5k 10°	144
86159	FL LED 50W NERO IP66 3K	130	40864	PRO/RIF 200W REGOLABILE 4K	139	45006	STREET S ED 60 L AS CYCLO 3K	147
86160	FL LED 10W NERO IP66 4K	130	40865	PRO/RIF 200W REGOLABILE 6K	139	45007	STREET S ED 60 L AS CYCLO 4K	147
86161	FL LED 20W NERO IP66 4K	130	40860DL	PRO/RIF 150W DALI 3K	139	45008	STREET S ED 60 L AS CYCLO 6K	147
86162	FL LED 30W NERO IP66 4K	130	40861DL	PRO/RIF 150W DALI 4K	139	45009	STREET S ED 80 L AS CYCLO 3K	147
86163	FL LED 50W NERO IP66 4K	130	40862DL	PRO/RIF 150W DALI 6K	139	45010	STREET S ED 80 L AS CYCLO 4K	147
86164	FL LED 20W NERO IP66 6K5	130	40863DL	PRO/RIF 200W DALI 3K	139	45011	STREET S ED 80 L AS CYCLO 6K	147
86165	FL LED 30W NERO IP66 6K5	130	40864DL	PRO/RIF 200W DALI 4K	139	45012	STREET S ED 110 L AS CYCLO 3K	147
86167	FL LED 20W NERO IP66 SENS 3K	130	40865DL	PRO/RIF 200W DALI 6K	139	45013	STREET S ED 110 L AS CYCLO 4K	147
86168	FL LED 50W NERO IP66 SENS 3K	130	40890	PRO/RIF 150W SDB 3K	139	45014	STREET S ED 110 L AS CYCLO 6K	147
86169	FL LED 20W NERO IP66 SENS 4K	130	40891	PRO/RIF 150W SDB 4K	139	45021	STREET S ED 60 L AS PARK 3K	147
86170	FL LED 50W NERO IP66 SENS 4K	130	40892	PRO/RIF 150W SDB 6K	139	45022	STREET S ED 60 L AS PARK 4K	147
86171	FL LED 20W NERO IP66 SENS 6K5	130	40893	PRO/RIF 200W SDB 3K	139	45023	STREET S ED 60 L AS PARK 6K	147
86179	FL LED 10W WHITE IP66 SENS 4K	130	40894	PRO/RIF 200W SDB 4K	139	45024	STREET S ED 80 L AS PARK 3K	147
86180	FL LED 20W WHITE IP66 SENS 4K	130	40895	PRO/RIF 200W SDB 6K	139	45025	STREET S ED 80 L AS PARK 4K	147

Analytical index

Cod.	Descrizione	Pag.
45026	STREET S ED 80 L AS PARK 6K	147
45027	STREET S ED 110 L AS PARK 3K	147
45028	STREET S ED 110 L AS PARK 4K	147
45029	STREET S ED 110 L AS PARK 6K	147
45036	STREET S ED 60 L AS STRA 3K	148
45037	STREET S ED 60 L AS STRA 4K	148
45038	STREET S ED 60 L AS STRA 6K	148
45039	STREET S ED 80 L AS STRA 3K	148
45040	STREET S ED 80 L AS STRA 4K	148
45041	STREET S ED 80 L AS STRA 6K	148
45042	STREET S ED 110 L AS STRA 3K	148
45043	STREET S ED 110 L AS STRA 4K	148
45044	STREET S ED 110 L AS STRA 6K	148
45051	STREET S ED 60 L SIM PARK 3K	148
45052	STREET S ED 60 L SIM PARK 4K	148
45053	STREET S ED 60 L SIM PARK 6K	148
45054	STREET S ED 80 L SIM PARK 3K	148
45055	STREET S ED 80 L SIM PARK 4K	148
45056	STREET S ED 80 L SIM PARK 6K	148
45057	STREET S ED 110 L SIM PARK 3K	148
45058	STREET S ED 110 L SIM PARK 4K	148
45059	STREET S ED 110 L SIM PARK 6K	148
45126	STREET S MV 60 L AS CYCLO 3K	148
45127	STREET S MV 60 L AS CYCLO 4K	148
45128	STREET S MV 60 L AS CYCLO 6K	148
45129	STREET S MV 80 L AS CYCLO 3K	148
45130	STREET S MV 80 L AS CYCLO 4K	148
45131	STREET S MV 80 L AS CYCLO 6K	148
45132	STREET S MV 110 L AS CYCLO 3K	148
45133	STREET S MV 110 L AS CYCLO 4K	148
45134	STREET S MV 110 L AS CYCLO 6K	148
45141	STREET S MV 60 L AS PARK 3K	148
45142	STREET S MV 60 L AS PARK 4K	148
45143	STREET S MV 60 L AS PARK 6K	148
45144	STREET S MV 80 L AS PARK 3K	148
45145	STREET S MV 80 L AS PARK 4K	148
45146	STREET S MV 80 L AS PARK 6K	148
45147	STREET S MV 110 L AS PARK 3K	148
45148	STREET S MV 110 L AS PARK 4K	148
45149	STREET S MV 110 L AS PARK 6K	148
45156	STREET S MV 60 L AS STRA 3K	148
45157	STREET S MV 60 L AS STRA 4K	148
45158	STREET S MV 60 L AS STRA 6K	148
45159	STREET S MV 80 L AS STRA 3K	148
45160	STREET S MV 80 L AS STRA 4K	148
45161	STREET S MV 80 L AS STRA 6K	148

Cod.	Descrizione	Pag.
45162	STREET S MV 110 L AS STRA 3K	148
45163	STREET S MV 110 L AS STRA 4K	148
45164	STREET S MV 110 L AS STRA 6K	148
45171	STREET S MV 60 L SIM PARK 3K	148
45172	STREET S MV 60 L SIM PARK 4K	148
45173	STREET S MV 60 L SIM PARK 6K	148
45174	STREET S MV 80 L SIM PARK 3K	148
45175	STREET S MV 80 L SIM PARK 4K	148
45176	STREET S MV 80 L SIM PARK 6K	148
45177	STREET S MV 110 L SIM PARK 3K	148
45178	STREET S MV 110 L SIM PARK 4K	148
45179	STREET S MV 110 L SIM PARK 6K	148
45186	STREET S SDB 60 L AS CYCLO 3K	148
45187	STREET S SDB 60 L AS CYCLO 4K	148
45188	STREET S SDB 60 L AS CYCLO 6K	148
45189	STREET S SDB 80 L AS CYCLO 3K	148
45190	STREET S SDB 80 L AS CYCLO 4K	148
45191	STREET S SDB 80 L AS CYCLO 6K	148
45192	STREET S SDB 110 L AS CYCLO 3K	148
45193	STREET S SDB 110 L AS CYCLO 4K	148
45194	STREET S SDB 110 L AS CYCLO 6K	148
45201	STREET S SDB 60 L AS PARK 3K	148
45202	STREET S SDB 60 L AS PARK 4K	148
45203	STREET S SDB 60 L AS PARK 6K	148
45204	STREET S SDB 80 L AS PARK 3K	148
45205	STREET S SDB 80 L AS PARK 4K	148
45206	STREET S SDB 80 L AS PARK 6K	148
45207	STREET S SDB 110 L AS PARK 3K	148
45208	STREET S SDB 110 L AS PARK 4K	148
45209	STREET S SDB 110 L AS PARK 6K	148
45216	STREET S SDB 60 L AS STRA 3K	148
45217	STREET S SDB 60 L AS STRA 4K	148
45218	STREET S SDB 60 L AS STRA 6K	148
45219	STREET S SDB 80 L AS STRA 3K	148
45220	STREET S SDB 80 L AS STRA 4K	148
45221	STREET S SDB 80 L AS STRA 6K	148
45222	STREET S SDB 110 L AS STRA 3K	149
45223	STREET S SDB 110 L AS STRA 4K	149
45224	STREET S SDB 110 L AS STRA 6K	149
45231	STREET S SDB 60 L SIM PARK 3K	149
45232	STREET S SDB 60 L SIM PARK 4K	149
45233	STREET S SDB 60 L SIM PARK 6K	149
45234	STREET S SDB 80 L SIM PARK 3K	149
45235	STREET S SDB 80 L SIM PARK 4K	149
45236	STREET S SDB 80 L SIM PARK 6K	149
45237	STREET S SDB 110 L SIM PARK 3K	149

Cod.	Descrizione	Pag.
45238	STREET S SDB 110 L SIM PARK 4K	149
45239	STREET S SDB 110 L SIM PARK 6K	149
46044	STRADA LED DL/MV 35 R EX 3K	150
46030	STRADA LED DL/MV 35 R EX 4K	150
46045	STRADA LED DL/MV 50 R EX 3K	150
46031	STRADA LED DL/MV 50 R EX 4K	150
46046	STRADA LED DL/MV 70 R EX 3K	150
46032	STRADA LED DL/MV 70 R EX 4K	150
46047	STRADA LED DL/MV 110 R EX 3K	150
46033	STRADA LED DL/MV 110 R EX 4K	150
46048	STRADA LED DL/MV 130 R EX 3K	150
46034	STRADA LED DL/MV 130 R EX 4K	150
46049	STRADA LED DL/MV 35 R EX L 3K	150
46035	STRADA LED DL/MV 35 R EX L 4K	150
46050	STRADA LED DL/MV 50 R EX L 3K	150
46036	STRADA LED DL/MV 50 R EX L 4K	150
46051	STRADA LED DL/MV 70 R EX L 3K	150
46037	STRADA LED DL/MV 70 R EX L 4K	150
46052	STRADA LED DL/MV 110 R EX L 3K	150
46038	STRADA LED DL/MV 110 R EX L 4K	150
46053	STRADA LED DL/MV 130 R EX L 3K	150
46039	STRADA LED DL/MV 130 R EX L 4K	150
46054	STRADA LED DL/MV 25 R UC 3K	150
46040	STRADA LED DL/MV 25 R UC 4K	150
46055	STRADA LED DL/MV 35 R UC 3K	150
46041	STRADA LED DL/MV 35 R UC 4K	150
46056	STRADA LED DL/MV 50 R UC 3K	150
46042	STRADA LED DL/MV 50 R UC 4K	150
46057	STRADA LED DL/MV 65 R UC 3K	150
46043	STRADA LED DL/MV 65 R UC 4K	150
46014	STRADA LED ZHAGA 35 R EX 3K	152
46000	STRADA LED ZHAGA 35 R EX 4K	152
46015	STRADA LED ZHAGA 50 R EX 3K	152
46001	STRADA LED ZHAGA 50 R EX 4K	152
46016	STRADA LED ZHAGA 70 R EX 3K	152
46002	STRADA LED ZHAGA 70 R EX 4K	152
46017	STRADA LED ZHAGA 110 R EX 3K	152
46003	STRADA LED ZHAGA 110 R EX 4K	152
46018	STRADA LED ZHAGA 130 R EX 3K	152
46004	STRADA LED ZHAGA 130 R EX 4K	152
46019	STRADA LED ZHAGA 35 R EX L 3K	152
46005	STRADA LED ZHAGA 35 R EX L 4K	152
46020	STRADA LED ZHAGA 50 R EX L 3K	152
46006	STRADA LED ZHAGA 50 R EX L 4K	152
46021	STRADA LED ZHAGA 70 R EX L 3K	152
46007	STRADA LED ZHAGA 70 R EX L 4K	152

Indice analitico

APPARECCHI / LUMINAIRES

Cod.	Descrizione	Pag.
46022	STRADA LED ZHAGA 110 R EX L 3K	152
46008	STRADA LED ZHAGA 110 R EX L 4K	152
46023	STRADA LED ZHAGA 130 R EX L 3K	152
46009	STRADA LED ZHAGA 130 R EX L 4K	152
46024	STRADA LED ZHAGA 25 R UC 3K	152
46010	STRADA LED ZHAGA 25 R UC 4K	152
46025	STRADA LED ZHAGA 35 R UC 3K	152
46011	STRADA LED ZHAGA 35 R UC 4K	152
46026	STRADA LED ZHAGA 50 R UC 3K	152
46012	STRADA LED ZHAGA 50 R UC 4K	152
46027	STRADA LED ZHAGA 65 R UC 3K	152
46013	STRADA LED ZHAGA 65 R UC 4K	152

ACESSORI / ACCESSORIES

Cod.	Descrizione	Pag.
40191	STAFFA ALTA PAN RTI 1200	14
70039	KIT CONTRO SOFFITTO PAN RTI	14,21
20089	CORNICE PLAF BACKLITE 600X600	14,21,26,28
70100	SUSPENSION 4 HOOK paneled	14,21,
70059	KIT CAVETTO DI SICUREZZA	14,21,26,
21102	CENTRALE DOMOTICA SD-LGFM	11,14,17,19,26,32,36,55,77,80,84,88,103,107,110,113,120,126,136,139,145,153
20104	TRASMETTITORE RADIO DOMOTICO	14,19,22,113,
26721	CARTUCCIA UV-OXY 200	18
20104SA	TRASMETTITORE RADIO SANIFICA ARIA	18
20101	CORNICE PLAF BACKLITE 300X1200	14,21,26,29,
15022	MODULO RADIO DOMOTICO	22
15024	MODULO DALI/PUSH TO DIMM	22
15034	MODULO 1-10V	22
70033	SUSPENSION WIRE paneled	26,29
70049	CLIPS UNIVERSALE CGESSO M600	26,29
20097	CORNICE PLAF LED PANEL 600X600	26
20100	CORNICE PLAF LED PANEL 300X1200	26
15064	CONCENTRATORE WIFI BLE	26,36,36,55,77,80,84,88,103,107,110,120,126,136,140,145,149,153
15174	CONC WIFI BLE EASY BOX	26,36,36,55,77,80,84,88,103,107,110,120,126,136,140,145,149,153
15074	CONC WIFI BLE ETHERNE EASY BOX	26,36,36,55,77,80,84,88,103,107,110,120,126,136,140,145,149,153
15053	MOD AUTODIM IP40	26,32,36,55,107,110,120,126,136,140,145,
15054	MOD AUTODIM RADIO IP40	26,32,36,55,103,107,110,120,126,136,140,145,149
15065	TRASMETTITORE BLE	26,32,36,55,77,80,84,88,103,107,110,120,126,136,140,145,149,153
15063	SENSORE PRESE BLE INDUSTRIA IP65	26,32,36,55,77,80,84,88,103,107,110,120,126,136,140,145,149,153
15062	SENSORE PRESE BLE UFFICI IP40	26,32,36,55,77,80,84,88,103,107,110,120,126,136,140,145,149,153
20080	P236/58 LED SOSP SINGOLO	32
20087	STAFFA + CAVO TRIFASE PASSANTE	32
20081	P236/58 LED SOSP+CAVO SINGOLO	32
20088	CAVO FILA CONT PLAFO	32
424020006	MAIN POWER L1500 REGLED ECO	47,49
424020003	CONNECTION PLUG 150 RGL LEDECO	47,49
424020005	CONN PLUG 1.5MT RGL LEDECO	47,49
424020009	CONNECTION PLUG 2MT RGL LEDECO	47,49
424020004	GR ACCESSORY RGL LEDECO	47,49
40460	RIF ROUND 15W TITANIUM	54
40462	RIF ROUND 32W TITANIUM	54
40461	RIF ROUND 24W TITANIUM	54

Analytical index

ACCESSORI / ACCESSORIES

Cod.	Descrizione	Pag.
40463	RIF ROUND 41W TITANIUM	54
40464	HONEYCOMB 15W	54
40466	HONEYCOMB 32W	54
40465	HONEYCOMB 24W	54
40467	HONEYCOMB 41W	54
40476	DOUBLE FILTER 15W	54
40478	DOUBLE FILTER 32W	54
40477	DOUBLE FILTER 24W	54
40479	DOUBLE FILTER 41W	54
40468	OVAL FILTER 15W	54
40470	OVAL FILTER 32W	54
40469	OVAL FILTER 24W	54
40471	OVAL FILTER 41W	54
40472	NARROW FILTER 15W	54
40474	NARROW FILTER 32W	54
40473	NARROW FILTER 24W	54
40475	NARROW FILTER 41W	54
40480	ADAPTER RING 150MM TO 220MM	5
40481	ADAPTER RING 130MM TO 220MM	5
40482	ADAPTER RING 110MM TO 220MM	5
8063	BS100 GRIGLIA PROTEZ 36/58W	76,80,84,87,91,93
15067	MODULO SD RADIO STAGNA MODULA	77
3905	GRIGLIA ILLUM 685X182X110	80,91,93
3505	BS100/110 K.GANCI ACC.4PZ.18W	80
3506	BS100/110 K.GANCI ACC. 8PZ.36W	80
3507	BS100/110 K.GANCI ACC.10PZ.58W	80
3504	BS100/110 STAFFE A PARETE	80
15050	MOD AUTODIM IP65	80,84,88
15051	MOD AUTODIM RADIO IP65	80,84,88
20107	SCHERMO ACC PROTEZ HCCP 1200	84
20113	SCHERMO ACC PROTEZ HCCP 1500	84
15019	RACCORDO DOPPIO INGRESSO M20	84,87
20122	STAFFA ORIENTABILE ACC E LED	84
15018	KIT ATEX ACCIAIO ECO	84
20123	ACCIAIO EX STAFFA ORIENTABILE	84
20125	ACCIAIO EX STAFFA PALO	84
12667	GRIGLIA FLOOD MODULA M	103,126
12663	CAVO SOSPENSIONE RIFLETTORE	103,106,109,120,126,136,140
12666	STAFFA GONIOMETRICA RIF PRO FH	106
12664	STAFFA FISSAGGIO PLAFONE	104,134,138
12658	GRIGLIA PRO/RIF GRANDI	104
12659	STAFFA FISSAGGIO BARRA ELET MF	106,136,140
12665	DISTANZIALE PLAFONE BS240 LED	109
40900	DIFFUSORE VETRO HP 100/150W	113
40901	DIFFUSORE VETRO HP 200/240W	113
40902	DIFFUSORE HP 120° 100/150W	113

Cod.	Descrizione	Pag.
40903	DIFFUSORE HP 120° 200/240W	113
40908	STAFFA ORIENTABILE HP 100/150W	113
40909	STAFFA ORIENTABILE HP 200/240W	113
40904	CAMPANA 70° HP 100/150W	113
40905	CAMPANA 70° HP 200/240W	113
40906	CAMPANA 90° HP 100/150W	113
40907	CAMPANA 90° HP 200/240W	113
40910	CAMPANA 70-80° HB MULTIPOWER	115
12668	GRIGLIA FLOOD MODULA S	120
12669	GOLFARI M5 FLOOD MODULA	120,126
20108	RICEVITORE RADIO SMART	133
12661	TESTA PALO 1X-2X D=60-76MM	136,140
12662	TESTA PALO 4X 60-76	136,140
12657	GRIGLIA PRO/RIF MED	136,140
20109	SOFTWARE SD MANAGER	11

Indice analitico / Analytical index

INVERTER

Cod.	Descrizione	Pag.
19355L	INV LED AT/LG AR 9W 55V LIFE	15,18,22,27,36
19391	INV EXT AT/LG AR 15W 55V LIFE	15,18,22,27,32
19375	MODULO LGFM INVERTER LED	15,18,27,36
19398	INV UNIV AT RM 5W 20-240V	15,18,22,27,29,36,54,80,85,88,91,95,110
19399	INV UNIV CT 5W 20-240V	15,18,22,27,29,36,54,80,85,88,91,95,110
15079	MODULO LG SLIM	15,18,22,27,29,32,36,54,80,85,88,91,95, 107,110,137,141
15037	MODULO LGFM	15,18,22,27,29,32,36,54,80,85,88,91,95, 107,110,137,141
15080	MODULO DALI SLIM	15,18,22,27,29,32,36,54,80,85,88,91,95, 107,110,137,141
19376	GUSCIO IP65 INVERTER LED	15,22,27
RA13	BOOSTER BAT LiFe 6.4V 1.5Ah	32,36,76,85,88,95,110,141
15068	MODULO TR 6W 1/3H BS UNO	76
15059	MODULO LG24	76
15060	MODULO LG230	76
15075	MODULO EPS	76
15069	MODULO TR 6W 1/3H PROIETTORI	103,120,126,149
15071	MODULO LG24 PROIETTORI	103,120,126,149
15070	MODULO LG230 PROIETTORI	103,120,126,149
15072	MODULO EPS PROIETTORI	103,120,126,149

Note

illuminazione / lighting

Resistenza chimica dei materiali

Gli apparecchi Beghelli sono garantiti se impiegati nelle condizioni ambientali per cui sono stati progettati. In caso di condizioni ambientali estreme e/o in presenza di sostanze chimiche aggressive, la valutazione dell'apparecchio da installare deve tenere conto delle compatibilità chimiche dei singoli materiali che lo compongono, indicato in ogni singola scheda di Apparecchio.

COMPONENTE CHIMICO CHEMICAL COMPONENT	TERMOPLASTICI / THERMOPLASTICS			
	METACRILATO / METACRYLATE (PMMA)	POLICARBONATO/ POLYCARBONATE (PC)	NYLON (PC)	PVC (PA)
ACETONE / ACETONE	✗	✓	✓	✓
ACIDO ARSENICO AL 20% / 20% ARSENIC ACID	✓	✓	-	✓
ACIDO CITRICO AL 10% / 10% CITRIC ACID	✓	✓	✓	✓
ACIDO CITRICO AL 20% / 20% CITRIC ACID	✓	✓	✓	✓
ACIDO ACETICO AL 10% / 10% ACETIC ACID	✓	✓	✗	✓
ACIDO CLORIDRICO / HYDROCHLORIC ACID	✓	✓	✗	✓
ACIDO CLORIDRICO AL 20% / 20% HYDROCHLORIC ACID	✓	✓	✗	✓
ACIDO CROMICO / CHROMIUM ACID	✓	✓	✓	✓
ACIDO FORMICO FINO AL 30% / FORMIC ACID UP TO 30%	✓	✓	✓	✓
ACIDO NITRICO AL 20% / 20% NITRIC ACID	✓	✓	✗	✓
ACIDO SOLFORICO FINO AL 30% / SULPHURIC ACID UP TO 30%	✓	✓	✗	✓
ALCOOL ETILICO / ETHYL ALCOHOL	✗	✓	✓	✓
ALCOOL ISOPROPILICO / ISOPROPYL ALCOHOL	✓	✗	✓	-
ANILINA / ANILINE	✗	✓	✓	✗
AMMONIACA 10% / 10% AMMONIA	✓	✗	✓	✓
BENZINA / PETROL	✓	✓	✓	✓
BENZOLE / BENZOL	✗	✗	✓	✗
BEVANDE ALCOLICHE / ALCOHOLIC BEVERAGES	✓	✓	✓	✓
BROMO / BROMINE	✗	✓	✗	✗
CLIMA MARINO / SEA CLIMATE	✓	✓	✓	✓
ACQUA DI MARE / SEA WATER	✓	✓	✓	✓
CALCE BIANCA / WHITE LIME	✓	✓	✓	✓
CARBURANTE DIESEL / DIESEL FUEL	✓	✓	✓	✓
CLORO LIQUIDO (VAPORI) / LIQUID CHLORINE (VAPOURS)	✗	✗	-	✗
CLOROFORMIO / CHLOROFORM	✗	✗	✓	✗
CLORURO DI CALCIO / CALCIUM CHLORIDE	✓	✓	✓	✓
CLORURO FERRICO / FERRIC CHLORIDE	✓	✓	✓	✓
ESANO / ESANE	✓	✗	✓	✓
ETERE / ETHER	✗	✗	✗	✗
ETERE DI PETROLIO (BENZENE) / PETROLEUM ETHER (BENZENE)	✓	✗	✓	✓
ETILENE / ETHYLENE	✓	✗	✓	✗
FENOLI / FENOLS	✗	✗	✗	-
GLICERINA / GLYCERIN	✓	✓	✓	✓
IDROCARBURI / HYDROCARBONS	✓	✗	✓	-
METANOLO / METHANOL	✗	✗	✓	✓
OLI MINERALI / MINERAL OILS	✓	✗	✓	✓
OLI VEGETALI / VEGETABLE OILS	✓	✓	✓	✓
OLIO DI SILICONE / SILICONE OIL	✓	✓	✓	✓
OLIO DIESEL-NAFTA / DIESEL OIL-NAFTA	✓	✓	✓	✓
OLIO E GRASSI ALIMENTARI / EDIBLE OIL AND FATS	✓	✓	✓	✓
OZONO / OZONE	✓	✓	✗	✓
PERMANGANATO DI POTASSIO / POTASSIUM PERMANGANATE	✓	✓	✗	✓
SODA	✓	✓	✓	✓
SODA CAUSTICA / CAUSTIC SODA	-	✓	✗	✓
SOLFATO DI ZINCO / ZINC SULPHATE	✓	✓	✓	✓
SOLFATO DI ALLUMINIO / ALUMINIUM SULPHATE	✓	✓	✓	✓
SOLFATO DI RAME / COPPER SULPHATE	✓	✓	✗	✓
TETRACLORURO DI CARBONIO / CARBON TETRACHLORIDE	✗	✗	✗	✗
TOLUOLO / TOLUENE	✗	✗	✓	✗
TRICLOROETILENE / TRICHLOROETHYLENE	✗	✗	✓	✗

Materials chemicals resistance

Beghelli luminaires guarantees when used in environmental conditions for which they have been designed. In the case of extreme environmental conditions and/or in the presence of aggressive chemicals, the assessment of the luminaire to be installed must take into account the chemical compatibility of the individual materials of which it is made, as indicated in each individual luminaire sheet.

COMPONENTE CHIMICO CHEMICAL COMPONENT	ACCIAIO / STEEL			ALTRI MATERIALI / OTHER MATERIALS	
	INOX / STAINLESS STEEL (304)	PREZINCATO VERNICIATO PRE-GALVANISED PAINTED	VERNICIATO PAINTED	ALLUMINIO ALUMINIUM	VETRO GLASS
ACETONE / ACETONE	✓	✓	✓	✓	✓
ACIDO ARSENICO AL 20% / 20% ARSENIC ACID	-	-	✓	✗	✓
ACIDO CITRICO AL 10% / 10% CITRIC ACID	✓	✓	✓	✓	✓
ACIDO CITRICO AL 20% / 20% CITRIC ACID	✓	✗	✗	✓	-
ACIDO ACETICO AL 10% / 10% ACETIC ACID	✓	✗	✗	✗	✓
ACIDO CLORIDRICO / HYDROCHLORIC ACID	✗	✗	✗	✗	-
ACIDO CLORIDRICO AL 20% / 20% HYDROCHLORIC ACID	✗	✗	✗	✗	✓
ACIDO CROMICO / CHROMIUM ACID	✓	✓	✗	✓	✓
ACIDO FORMICO FINO AL 30% / FORMIC ACID UP TO 30%	✓	✗	✗	✗	✗
ACIDO NITRICO AL 20% / 20% NITRIC ACID	✓	✗	✗	✗	✓
ACIDO SOLFORICO FINO AL 30% / SULPHURIC ACID UP TO 30%	✗	✗	✗	✗	✓
ALCOOL ETILICO / ETHYL ALCOHOL	✓	✓	✓	✓	✓
ALCOOL ISOPROPILICO / ISOPROPYL ALCOHOL	✓	✓	✗	✓	✓
ANILINA / ANILINE	✓	✓	✓	✗	✓
AMMONIACA 10% / 10% AMMONIA	✓	✓	✓	✓	✓
BENZINA / PETROL	✓	✓	✓	✓	✓
BENZOLO / BENZOL	✓	✓	✓	✓	✓
BEVANDE ALCOLICHE / ALCOHOLIC BEVERAGES	✓	✓	✓	✓	✓
BROMO / BROMINE	✗	✗	✗	✗	✓
CLIMA MARINO / SEA CLIMATE	✓	✗	✗	✗	✓
ACQUA DI MARE / SEA WATER	✓	✗	✗	✓	✓
CALCE BIANCA / WHITE LIME	✓	✓	✓	✓	-
CARBURANTE DIESEL / DIESEL FUEL	✓	✓	✓	✓	-
CLORO LIQUIDO (VAPORI) / LIQUID CHLORINE (VAPOURS)	✗	-	✗	✗	✗
CLOROFORMIO / CHLOROFORM	✓	✓	✓	✓	✓
CLORURO DI CALCIO / CALCIUM CHLORIDE	✓	✗	✓	✗	✓
CLORURO FERRICO / FERRIC CHLORIDE	✗	✗	✗	✗	-
ESANO / ESANE	✓	✓	✓	✓	✓
ETERE / ETHER	✓	✓	✓	✓	✓
ETERE DI PETROLIO (BENZENE) / PETROLEUM ETHER (BENZENE)	✓	✓	✓	✓	-
ETILENE / ETHYLENE	✓	✗	✗	✓	✓
FENOLI / FENOLS	✓	✗	✗	✓	✓
GLICERINA / GLYCERIN	✓	✓	✓	✓	✓
IDROCARBURI / HYDROCARBONS	✓	✓	✓	✓	✓
METANOLO / METHANOL	✓	✓	✓	✓	✓
OLI MINERALI / MINERAL OILS	✓	✓	✓	✓	✓
OLI VEGETALI / VEGETABLE OILS	✓	✓	✓	✓	✓
OLIO DI SILICONE / SILICONE OIL	✓	✓	✓	✓	✓
OLIO DIESEL-NAFTA / DIESEL OIL-NAFTA	✓	✓	✓	✓	✓
OLIO E GRASSI ALIMENTARI / EDIBLE OIL AND FATS	✓	✓	✓	✓	✓
OZONO / OZONE	✓	✓	✗	✓	✓
PERMANGANATO DI POTASSIO / POTASSIUM PERMANGANATE	✓	✓	✓	✓	✓
SODA	✓	✓	✓	✗	✗
SODA CAUSTICA / CAUSTIC SODA	✓	✓	-	✗	✗
SOLFATO DI ZINCO / ZINC SULPHATE	✓	✗	✗	✗	-
SOLFATO DI ALLUMINIO / ALUMINIUM SULPHATE	✓	✗	✗	✓	✓
SOLFATO DI RAME / COPPER SULPHATE	✓	✗	✗	✗	✓
TETRACLORURO DI CARBONIO / CARBON TETRACHLORIDE	✓	✗	✗	✗	✓
TOLUOLO / TOLUENE	✓	✓	✓	✓	✓
TRICLOROETILENE / TRICHLOROETHYLENE	✓	✓	✓	✗	-

✓ Resistente / Resistant ✓ Relativamente resistente / Relatively resistant ✗ Non resistente / Not resistant

Condizioni generali di vendita

1. ORDINI - PERFEZIONAMENTO DEGLI ACCORDI

Gli ordini di acquisto dei prodotti devono essere formulati per iscritto. Il conferimento dell'ordine si intende irrevocabile. Tutti i programmi di collaborazione, gli ordini, le commissioni e gli accordi si intendono perfezionati, con la conferma scritta o verbale dalla Venditrice o, comunque, con l'inizio della fatturazione e/o della consegna dei prodotti ordinati.

2. VARIANTI E MODIFICHE

Dopo il perfezionamento dell'ordine ogni modifica o integrazione al contenuto ed alle condizioni dell'ordine sarà valida e diventerà efficace unicamente con la trasmissione da parte della Venditrice all'Acquirente di una variante della conferma. Il testo della conferma o della variante di conferma della Venditrice prevarrà in ogni caso su qualunque altro documento. L'Acquirente che non intendesse accettare le condizioni difformi rispetto al proprio ordine, dovrà rilevarlo entro 20 (venti) giorni dalla data di conferma, senza di che la variante di conferma si intenderà integralmente accettata.

3. MODALITÀ DI ACCETTAZIONE

Alla Venditrice non potrà essere addossata alcuna responsabilità per mancata accettazione di un ordine, ovvero per mancata o ritardata fornitura dei prodotti oggetto dello stesso. L'accettazione e l'esecuzione dell'ordine sono specificamente subordinate alla disponibilità dei prodotti ordinati nonché all'assenza di circostanze che possano comunque influire sulla reperibilità dei medesimi e sulla tempestività della consegna degli stessi.

4. TERMINI DI CONSEGNA

I termini di consegna comunicati dalla Venditrice hanno valore puramente indicativo. I termini di consegna espressi in giorni sono normalmente computati in giorni lavorativi. Le eventuali modifiche dei termini di consegna richieste dall'Acquirente dovranno essere accettate per iscritto dalla Venditrice. Gli eventuali ritardi in consegna, così come le interruzioni e/o le sospensioni totali o parziali delle forniture, anche se non dovute a cause di forza maggiore e/o caso fortuito, non daranno diritto al risarcimento di danni e/o indennizzi di qualsiasi genere e neppure ad interessi, salva la sola facoltà per l'Acquirente di annullare l'ordine, previa messa in mora della Venditrice di almeno trenta giorni decorrenti dal giorno di ricevimento della raccomandata A.R. inviata dall'Acquirente.

5. FORZA MAGGIORE

A titolo meramente indicativo ed esemplificativo, ma non tassativo, sono considerati casi di forza maggiore: scioperi, serrate, tumulti, conflitti di lavoro, guerre, incendi, calamità naturali, impossibilità di approvvigionamento dei prodotti, interruzioni o difficoltà dei trasporti ritardi di spedizione, mancanza di materie prime, attacchi informatici e hacking, atti governativi, provvedimenti di autorità, eventuali inadempimenti di fornitori e, in genere, ogni evento imprevedibile che sia al di fuori della ragionevole possibilità di controllo da parte della Venditrice. In tutti tali casi, così come nell'ipotesi di caso fortuito, la Venditrice si riserva la facoltà di sospendere e/o ritardare la consegna dei prodotti ed anche di annullare gli ordini, anche se già confermati, senza che ciò possa dar diritto all'Acquirente di richiedere alla Venditrice il risarcimento di danni e/o indennizzi di qualsiasi tipo, ivi inclusi quelli diretti, indiretti e consequenziali.

6. CONSEGNA - TRASPORTO

La merce viaggia sempre a rischio e pericolo dell'Acquirente, anche se spedita in porto franco e/o con automezzo della Venditrice, per cui la Venditrice non accetterà contestazioni per eventuali rotture e/o manomissioni dei prodotti. La consegna dei prodotti si intende effettuata presso la sede della Venditrice a Monteveglio - Valsamoggia (Bologna) o presso depositi terzi con i quali la Venditrice ha stipulato apposite convenzioni (condizione "Ex works" - Incoterms 2010). Le spese di trasporto sono a carico dell'Acquirente. La Venditrice non accetta imballi di ritorno.

7. RECLAMI - SOSTITUZIONE DEI PRODOTTI

Per sostituzioni e reclami si applicano le tutele previste dalla legislazione applicabile alla specifica tipologia di cliente, operatore professionale o consumatore. Non appena ricevuti i prodotti, l'Acquirente sarà tenuto a verificare lo stato, la quantità della fornitura e la sua rispondenza alla bolla di consegna. Eventuali reclami in merito alla qualità, quantità, tipo del prodotto, dovranno essere fatti per iscritto entro 8 (otto) giorni dalla data di ricevimento della merce. Decorso tale termine, fatte comunque salve le diverse condizioni di garanzia previste per i singoli prodotti, nessun reclamo potrà più essere avanzato sia per la sostanza e la qualità della merce, sia per le condizioni in genere della stessa. L'Acquirente non potrà per nessuna ragione restituire i prodotti senza la preventiva autorizzazione scritta della Venditrice né ritardare e/o sospendere totalmente o parzialmente il pagamento delle fatture, neppure nel caso di reclami. Qualora il reclamo risulti fondato a giudizio della Venditrice, e sia stato proposto entro i termini di garanzia riportati nei libretti illustrativi che accompagnano i singoli prodotti, l'obbligo di questa si limita alla semplice sostituzione del prodotto non conforme secondo le modalità di consegna della prima fornitura. Resta pertanto escluso qualunque diritto dell'Acquirente di annullare l'ordine o di ottenere qualsiasi risarcimento per spese e/o danni. Il diritto alla sostituzione del prodotto contestato

decade se il prodotto non viene conservato diligentemente, tenuto a disposizione della Venditrice, nonché immediatamente restituito nel luogo stabilito dalla Venditrice.

8. APPLICAZIONE DELLA GARANZIA

La garanzia si applica esclusivamente per vizi e/o difetti di conformità del prodotto in relazione ai termini e alle condizioni indicate nelle specifiche tecniche dichiarate e/o concordate o per rottura prematura di una delle sue parti. Il periodo di validità della suddetta garanzia è per un periodo minimo di 24 mesi decorrenti dalla data di acquisto dimostrabile attraverso la presentazione di un documento fiscalmente valido. Gli apparecchi che beneficiano di garanzie estese sono contrassegnati nei cataloghi o nei fogli istruzioni con il numero di anni di garanzia complessivi in abbinamento con la lettera G (es. contrassegno 5G per prodotti che beneficiano di 5 anni di garanzia). Di norma si applicano le seguenti estensioni: gli apparecchi di illuminazione di emergenza e i sistemi di illuminazione di emergenza centralizzata beneficiano di 5 anni di garanzia, quelli equipaggiati di batterie con nuova tecnologia al Litio, con denominazione TEN YEARS, beneficiano di 10 anni di garanzia (su tutte le parti, batterie comprese); apparecchi illuminazione EcoDriver - ED - o Regolabili - RD - beneficiano di 3 anni di garanzia, apparecchi illuminazione SmartDriver - SD - beneficiano di 5 anni di garanzia (su tutte le parti, sorgenti incluse). La garanzia non si applica in caso di manomissione, per difetti causati da danni accidentali di qualsiasi natura, anche durante il trasporto e l'installazione, per utilizzo improprio o non conforme alle specifiche di prodotto, per negligenza nell'uso e nella manutenzione, per errori di installazione o collegamento, in caso di installazione non eseguita da personale qualificato e comunque non realizzata a Regola d'Arte. Salvo diversa prescrizione di Legge applicabile, la garanzia si limita alla sola sostituzione/riparazione del prodotto o delle parti non conformi secondo le modalità di consegna della prima fornitura. L'intervento in garanzia da parte della Venditrice rimane subordinato alla osservanza delle condizioni di pagamento da parte dell'Acquirente.

9. PREZZI

I prezzi indicati nei listini della Venditrice non sono impegnativi, di conseguenza la Venditrice si riserva il diritto di modificarli fino al momento della consegna dei prodotti. I prezzi s'intendono al netto di IVA e di altri eventuali oneri fiscali.

10. PAGAMENTI

Tutti i pagamenti dovranno essere effettuati nei termini e nelle modalità indicate dalla Venditrice presso la sede della Venditrice in Monteveglio - Valsamoggia (Bologna). In caso di ritardo nel pagamento, l'acquirente inadempiente sarà tenuto a corrispondere alla Venditrice gli interessi di mora dalla scadenza del termine contrattuale fino al saldo, nella misura prevista dal D.lgs. 231/2002, salvo in ogni caso il risarcimento per i maggiori danni subiti. Il mancato rispetto dei termini di pagamento da parte dell'Acquirente darà la facoltà alla Venditrice di risolvere il relativo contratto di fornitura con effetto immediato e di sospendere la consegna di tutti i prodotti comunque ordinati senza necessità di comunicazione alcuna, con il conseguente diritto per la Venditrice di esigere l'immediato pagamento dell'intero credito nonché di agire per il risarcimento dei danni subiti. In caso di inadempimento, e/o di peggioramento delle condizioni patrimoniali che mettano in pericolo l'incasso del credito da parte della Venditrice, e/o di prolungato ritardo nei pagamenti e/o di elevata esposizione debitoria complessiva (anche per effetto di precedenti vendite non incassate) da parte dell'Acquirente, la Venditrice si riserva di applicare le disposizioni degli art. 1460 e 1461 CC, di intraprendere le opportune azioni cautelari e di ricorrere a qualsiasi altra forma di autotutela consentita; è ulteriormente convenuto che in tali casi la Venditrice può sospendere ogni e qualsiasi fornitura.

11. RISERVATO DOMINIO

I prodotti si intendono venduti con patto di riservato dominio; gli stessi pertanto resteranno di proprietà della Venditrice fino all'avvenuto saldo integrale del relativo prezzo. L'Acquirente si impegna quindi ad informare i terzi dell'esistenza ed efficacia del presente patto di riservato dominio, nonché a salvaguardare i diritti della Venditrice derivanti dal medesimo.

12. SALVAGUARDIA - CONTROVERSIE E FORO COMPETENTE

L'invalidità o l'inapplicabilità di una delle clausole contenute nelle presenti condizioni generali di vendita, non pregiudicherà, o sminuirà la validità ed applicabilità delle altre disposizioni; la Venditrice e l'Acquirente si impegnano fin d'ora a sostituire le clausole dichiarate inefficaci e/o nulle, ovvero impraticabili, con altra disposizione dagli effetti analoghi. Per qualsiasi controversia o contestazione relativa all'interpretazione, validità ed esecuzione dell'ordine o comunque connessa ai contratti cui si applicano le presenti condizioni generali di vendita sarà disciplinata dalla Legge Italiana. Foro competente, in via esclusiva, è il Foro di Bologna.

13. TRATTAMENTO DATI PERSONALI

I dati personali raccolti dalla Venditrice in sede d'ordine saranno trattati ai sensi del Reg. EU 2016/679 Regolamento Europeo in materia di protezione dei dati personali come da privacy policy presente sul sito www.beghelli.it

Sicurezza prodotti e direttive UE

SICUREZZA PRODOTTI E DIRETTIVE EUROPEE

I prodotti Beghelli sono costruiti a regola d'arte in materia di sicurezza e qualità e non compromettono anche nelle condizioni di sovraccarico prevedibili, la sicurezza delle persone, degli animali domestici e dei beni, se installati e utilizzati in conformità alla loro destinazione e nelle condizioni ambientali previste, montati in modo non difettoso e soggetti ad idonea manutenzione da parte di personale qualificato.

Per quanto applicabili, i prodotti sono costruiti in conformità ai requisiti di cui alle direttive comunitarie 2014/35/EU, 2014/30/EU, 2014/53/EU, 2014/30/EU, 2009/125/CE, 2001/65/CE.

La marcatura CE apposta sul prodotto e/o sull'imballaggio e/o sulle eventuali avvertenze d'uso che accompagnano il prodotto attesta la conformità alle Direttive di cui sopra. Beghelli conserva un proprio Archivio Tecnico, a disposizione delle autorità competenti per eventuali ispezioni, contenente la documentazione che dimostra che il prodotto è stato esaminato per valutarne la conformità.

I prodotti che non ricadono nel campo di applicazione delle Direttive CE sopra indicate sono conformi agli standard qualitativi previsti dalle normative vigenti e alla Direttiva 2001/95/CE ("Direttiva sicurezza Generale dei prodotti"), recepita con D.lgs. n. 172/2004.

I dati contenuti nel presente catalogo possono essere soggetti a variazione senza preavviso.

Le indicazioni, misure, disegni e foto dei prodotti e dei componenti sono riportate a titolo informativo e possono essere modificate senza preavviso, non essendo intese come informazioni precontrattuali. Tutti i prodotti per cui è prevista la connessione alla rete elettrica, devono essere installati secondo le norme impiantistiche in vigore nei paesi di destinazione e secondo le informazioni contenute nel Catalogo e/o sulle relative istruzioni allegate al prodotto stesso.

Difesa dell'ambiente

DIRETTIVA RAEE 2012/19/UE

Sono in rapido incremento le quantità di rifiuti riconducibili ad apparecchiature elettriche ed elettroniche (RAEE), tra queste sono state incluse anche gran parte delle sorgenti luminose.

La direttiva si propone come scopo principale quello di impedire che i RAEE a fine vita vengano gettati nelle discariche o negli inceneritori provocando un ulteriore grave impatto ambientale.

La direttiva 2012/19/UE ha dunque cercato di indurre un meccanismo di controllo che preveda una gestione controllata del dispositivo a fine vita privilegiando il suo reimpiego o il suo riciclaggio. Inoltre il meccanismo legislativo promuove concetti di progettazione e produzione che rendano più agevole lo smaltimento dei prodotti sia in termini di disassemblaggio che di materiali.

Tutti i passaggi della catena commerciale sono chiamati a dare un proprio contributo, chi in termini economici, chi in termini di attività affinché lo spirito della direttiva sia rispettato (e l'ambiente tutelato).

In Italia la direttiva è stata recepita con D. Lgs. n. 49 del 14 marzo 2014.

QUESTI I PRINCIPALI OBBLIGHI PREVISTI

Il produttore (inteso in senso ampio e dunque sostanzialmente chi appone il proprio marchio sul bene e chi importa da paese terzo) è responsabile dei costi di smaltimento dei propri prodotti giunti a fine vita.

Il consumatore è chiamato ad una gestione intelligente del bene a fine vita conferendolo

ad una piazzola attrezzata, ad un punto vendita o seguendo le indicazioni fornite dal costruttore.

Beghelli, da sempre sensibile alla problematica ambientale, è tra i soci fondatori del consorzio ECOLIGHT.

Scegliere prodotti di aziende che hanno aderito a consorzi volontari per il recupero e riciclaggio dei beni è scelta responsabile ed ecologicamente corretta a tutela dell'ambiente e del nostro futuro.

I prodotti che ricadono nel campo di applicazione delle direttive RAEE sono identificati dal simbolo presente simbolo.



DIRETTIVA ROHS 2011/65/UE

Al fine di agevolare il recupero, il riciclo delle apparecchiature elettriche e ad evitare che si accumulino nell'ambiente sostanze pericolose, la comunità Europea ha promulgato la direttiva ROHS. Essenzialmente questa direttiva precisa che:

Fatto salvo quanto stabilito all'allegato 3, è vietato immettere sul mercato apparecchiature elettriche ed elettroniche nuove rientranti nelle categorie individuate nell'allegato 1, contenenti piombo, mercurio, cadmio, cromo esavalente, bifenili polibromurati (PBB) od etere di difenile polibromurato (PBDE) in quantità superiore a quanto previsto all'allegato 2. In Italia la direttiva è stata recepita con D. Lgs. n. 27 del 4 marzo 2014.

ECOLIGHT



Concessionario Marchio IMQ



Partner DIALUX

Associato:



Assil



I dati tecnici indicati nel presente catalogo sono in continua evoluzione. Per verificare l'ultimo aggiornamento tecnico degli apparecchi, consultare il Catalogo elettronico presente sul sito www.beghelli.com

Sul sito sono inoltre disponibili i cataloghi in formato digitale delle varie linee di prodotto che possono comunque essere richiesti in versione cartacea a:

Beghelli S.p.A. - Direzione Commerciale - Via Mozzeghine, 13/15 Valsamoggia Loc. Monteveglio - 40053 BO

Numero Verde
800-626626

© Copyright 2024

Beghelli

BEGHELLI S.p.A. Via Mozzeghine 13/15 - 40053 Valsamoggia loc. Monteveglio
Bologna - Italy - Tel. +39 051 9660411 - info@beghelli.it - www.beghelli.com

General terms and conditions of sale

1. ORDERS - FINALISATION OF AGREEMENTS

Product purchase orders shall be formulated in writing. Order placement is deemed irrevocable. All collaboration programs, orders, work orders and agreements are considered finalised by the written or verbal confirmation of the Seller or, however, as soon as the invoicing and/or delivery of the ordered products is initiated.

2. VARIANTS AND MODIFICATIONS

After order finalisation, any modification or addition to the content and conditions of the order shall be valid and will become effective only after the Buyer receives a confirmation variant from the Seller. The text of the Seller's confirmation or confirmation variant shall in all cases prevail over any other document. If the Buyer does not intend to accept the conditions that differ from his/her order, he/she must inform the Seller within 20 (twenty) days from the date of confirmation; otherwise, the confirmation variant will be considered fully accepted.

3. METHOD OF ACCEPTANCE

The Seller shall not be held liable for any unaccepted orders or for any failed or delayed delivery of the products part thereof. Acceptance and execution of the order are specifically subject to the availability of the products ordered as well as the absence of circumstances that may affect the availability of the same and the timeliness of their delivery.

4. TERMS OF DELIVERY

The delivery terms communicated by the Seller are purely indicative. Delivery terms expressed in days are normally counted in working days. Any changes to the delivery terms requested by the Buyer must be first accepted in writing by the Seller. Any delay in deliveries, as well as any interruption and/or total or partial suspension of supplies, even if not due to force majeure and/or accidental circumstances, will not entitle the Buyer to compensation for damages and/or to any other kind of indemnity or interest, except for the sole right to cancel the order, provided that the Seller is notified in advance, with at least thirty days before the day of receipt of the registered letter with acknowledgement of receipt sent by the Buyer.

5. FORCE MAJEURE

By way of example, but not limited to, the following are considered cases of force majeure: strikes, lockouts, riots, labour conflicts, fires, natural disasters, impossibility of supplying products, interruptions or difficulties in transport, delays of shipment, lack of raw materials, government acts, authority measures, contractual non-fulfilment by suppliers and, in general, any unforeseeable event that is outside the reasonable control of the Seller. In all such cases, as well as in the event of any accidental circumstances, the Seller reserves the right to suspend and/or delay the delivery of the products and even cancel the orders, even if already confirmed; this will not entitle the Buyer to compensation for damages and/or to any other kind of indemnity, including those for direct, indirect and consequential loss.

6. DELIVERY - TRANSPORT

The goods always travel at the risk and danger of the Buyer, even if delivered carriage paid and/or using a vehicle of the Seller; therefore, the Seller will not accept disputes for any product breakage and/or tampering. The delivery of the products is intended to be carried out at the Seller's headquarters in Monteveglio - Valsamoggia (Bologna) or at third party warehouses with which the Seller has entered into special agreements ("Ex works" condition - Incoterms 2010). Transport costs are borne by the Buyer. The Seller does not accept returns.

7. COMPLAINTS - PRODUCT REPLACEMENT

Any requests for replacement and complaints shall be handled by applying the safeguards provided by the applicable legislation in relation to the specific type of customer, professional operator or consumer. Upon product receipt, the Buyer must check its condition, the quantity delivered and its compliance with the delivery note. Any complaints concerning product quality, quantity or type shall be submitted in writing within 8 (eight) days from the date of receipt of the goods. After this period, without prejudice to the warranty conditions provided for the individual products, no claim can be made regarding the material and quality of the goods, or their condition in general. The Buyer may not, under any circumstances, return the products without the prior written authorisation of the Seller, nor delay and/or suspend the payment of invoices in whole or in part, not even in the case of complaints. If, in the opinion of the Seller, the claim is justified and has been filed within the warranty terms stated in the booklets accompanying the individual products, the obligation of the latter is limited only to the replacement of the nonconforming product in accordance with the delivery terms established for the first delivery. It is, therefore, excluded any right of the Buyer to cancel the order or to obtain any compensation for expenses and/or damages. The right to replace the contested product shall lapse if the product is not diligently stored, kept at the disposal of the Seller, and returned immediately to the place determined by the Seller.

8. APPLICATION OF WARRANTY

The warranty applies only to faults and/or defects in the conformity of the product in relation to the terms and conditions indicated in the declared and/or agreed technical specifications or in case of premature breakage of one of its parts. The validity period of the aforementioned warranty is at least 24 months from the date of purchase, which can be proved by presenting a valid tax document. Luminaires with extended warranties are marked in catalogues or instruction sheets with the number of years of total warranty in conjunction with the letter G (e.g., 5G marking for products with a 5-years warranty). As a general rule, the following extensions apply: emergency luminaires equipped with Lithium Iron batteries (LiFe) and centralised emergency lighting systems benefit from a 5-years warranty, those equipped with Lithium Titanate batteries (LTO) benefit from a 10-years warranty (for all parts, including batteries); EcoDriver or Dimmable luminaires benefit from a 3-years warranty, SmartDriver luminaires benefit from a 5-years warranty (for all parts, including sources). The warranty does not apply in case of tampering, to defects caused by accidental damage of any kind, including during transport and installation, in case of improper use or use in disagreement with the product specifications, in case of negligence in use and maintenance, errors in installation or connection, and installation performed by unqualified personnel or without respecting the state-of-the-art standards. Unless otherwise required by applicable law, the warranty is limited only to the replacement/repair of nonconforming products or parts, according to the delivery terms of the first delivery. All work performed under warranty by the Seller shall be subject to observance of the payment conditions by the Buyer.

9. PRICES

The prices indicated in the Seller's price lists are not binding; therefore, the Seller reserves the right to modify them until the time of delivery of the products. All prices are exclusive of VAT and any other tax charges.

10. PAYMENTS

All payments shall be made, within the terms and in the manner indicated by the Seller, to its headquarters in Monteveglio - Valsamoggia (Bologna) or to the appointed person authorised in writing by the Seller. In case of delay in payment, the defaulting buyer will be obliged to pay the Seller interests on late payment from the date of expiry of the contractual period until settlement, to the extent provided for in Legislative Decree 231/2002, apart from any compensation for any further damages incurred. Failure to comply with the payment terms by the Buyer will give the Seller the right to terminate the corresponding supply contract with immediate effect and to suspend the delivery of all products ordered without the need for any communication, with the consequent right of the Seller to demand the immediate payment of the entire credit as well as to claim compensation for the damages incurred. In case of non-fulfilment and/or worsening of the patrimonial conditions of the Buyer to a degree that may jeopardise the collection of the credit by the Seller, as well as in the event of prolonged delay in payments and/or high total debt exposure (also due to previous uncollected sales), the Seller reserves the right to apply the provisions of art. 1460 and 1461 CC, undertake appropriate precautionary actions and resort to any other form of self-protection permitted; it is further agreed that in such cases the Seller may suspend any and all supplies.

11. LIEN AGREEMENT

The products sold are subject to a lien agreement; therefore, the Seller will retain possession of the goods sold until their price is paid in full. The Buyer, therefore, undertakes to inform third parties of the existence and effectiveness of this Lien Agreement, as well as to safeguard the Seller's rights deriving from the same.

12. SAFEGUARDING – DISPUTES AND JURISDICTION

The invalidity or unenforceability of any of the clauses contained in these general conditions of sale shall not affect, or detract from the validity and enforceability of the other provisions; the Seller and the Buyer undertake to replace any clauses declared ineffective and/or null, or impracticable, with other provisions having similar effects. For any dispute or contestation relating to the interpretation, validity and execution of the order or, in any case, concerning the contracts to which these general conditions of sale apply shall be governed by the Italian Law. The Forum of Bologna shall have exclusive jurisdiction.

Product safety and European Directives

PRODUCT SAFETY AND EUROPEAN DIRECTIVES

Beghelli products are manufactured according to the state-of-the-art standards concerning safety and quality and will not affect, even when used under foreseeable overload conditions, the safety of persons, pets and property, on condition that they are correctly installed and used according to their intended purpose in the recommended environmental conditions and subject to proper maintenance by qualified personnel.

To the extent applicable, the products shall be manufactured in accordance with the requirements of Community Directives 2014/35/EU, 2014/30/EU, 2014/53/EU, 2014/30/EU, 2009/125/CE, 2001/65/CE.

The CE marking affixed to the product and/or packaging and/or any warnings of use accompanying the product attest to the conformity of the product with the aforementioned Directives. Beghelli has its own Technical Archive, available to the competent authorities for possible inspections, containing documentation

demonstrating that the product has been examined to assess its compliance.

Products that do not fall within the scope of the above-mentioned EC Directives comply with the quality standards laid down by the regulations in force and by Directive 2001/95/CE ("General Product Safety Directive"), transposed by Legislative Decree No. 172/2004.

The data contained in this catalogue may be subject to change without notice.

The indications, dimensions, drawings and photos of the products and components are given for informational purposes only and may be modified without prior notice, as they do not constitute pre-contractual information. All products intended to be connected to the mains shall be installed in compliance with the installation standards in force in the country of use, observing the information contained in the Catalogue and/or the relevant instructions supplied with the product itself.

Environmental protection

WEEE DIRECTIVE 2012/19/EU

The quantities of waste from electrical and electronic equipment (WEEE) are rapidly increasing; most of the light sources are included in this category.

The main aim of the directive is to prevent WEEE from being discarded to landfills or incinerators at the end of their life, thereby causing further serious environmental impact. Directive 2012/19/EU, therefore, sought to induce a control mechanism which provides for a controlled end-of-life management of the device by giving priority to its reuse or recycling. In addition, the legislative mechanism promotes design and production concepts that make it easier to dispose of the products in terms of both their disassembly and their materials.

All supply chain participants are invited to make their own contribution, some with regard to the economic aspects, some in terms of activity, so that the spirit of the directive is respected (and the environment is protected).

In Italy, the Directive has been transposed by Legislative Decree No. 49 of 14 March 2014.

THESE ARE THE MAIN OBLIGATIONS FORESEEN

The manufacturer (understood in a broad sense and, therefore, essentially as the person who affixes one's own brand on the goods and who imports them from third countries) is responsible for the costs of disposing of their products at the end of their life.

The consumer is required to guarantee an intelligent end-of-life management of the product by sending it to a specially equipped site, a point of sale or by observing the instructions provided by the manufacturer.

Beghelli, always sensitive to environmental issues, is one of the founding members of the ECOLIGHT consortium.

Choosing products from companies that have joined voluntary consortia for the recovery and recycling of goods is the responsible and ecologically correct choice to protect the environment and our future.

Products falling under the scope of the WEEE Directive are identified by this symbol.



ROHS DIRECTIVE 2011/65/UE

In order to facilitate the recovery and recycling of electrical equipment and to prevent hazardous substances from accumulating into the environment, the European Community has enacted the ROHS Directive. Essentially, this Directive states that:

Without prejudice to Annex 3, the placing on the market of new electrical and electronic equipment falling within the categories identified in Annex 1 containing lead, mercury, cadmium, hexavalent chromium, polybrominated biphenyls (PBB) or polybrominated diphenyl ether (PBDE) in excess of the value indicated in Annex 2, shall be prohibited.

In Italy, the Directive has been transposed by Legislative Decree No. 27 of 4 March 2014.

ECOLIGHT



Concessionario
Marchio IMQ



Partner **DIALUX**

Associato:



Assil



The technical data and images in this catalogue are subject to continuous development and may change without notice. To check the latest technical update of the luminaires, please refer to the electronic catalogue on www.beghelli.com.

Digital catalogues of the various product ranges are also available on the website and can also be requested in hard copy from:

BEGHELLI S.p.A. - Commercial Division - Via Mozzeghine, 13/15 Valsamoggia Loc. Monteveglio - 40053 BO

Freephone Number
800-626626

© Copyright 2024

Beghelli

BEGHELLI S.p.A. Via Mozzeghine 13/15 - 40053 Valsamoggia loc. Monteveglio
Bologna - Italy - Tel. +39 051 9660411 - info@beghelli.it - www.beghelli.com