

emergency

twenty-one



REVERSOS

Beghelli

# Let's start embracing the Earth again

Since 1982, we have been focusing on the interaction between technology and safety, a concept that has evolved up to now, and which for us translates into offering people the opportunity to enjoy a healthy and peaceful working and living environment.

LIGHT, the core of our business, now integrates more than ever those elements of well-being, safety and respect for the environment, which are the values and mission of our company.

We work directly with industrial and commercial entities in 9 different countries, and we distribute products in other 100 countries, safeguarding the human rights and equal opportunities of our collaborators.

Our passion for innovation, research and services translates into a technological offer that is ever closer to people's needs, while safeguarding the planet. Products such as the Salvalavita, the LED emergency luminaires and high energy-saving lighting are just a few examples.

We strongly believe that the only possible future is through respect for the environment. This is why we have a certified environmental management system.

This is why "ArchiEco", an architectural emergency range made of technopolymers of organic origin. This is why Titanium dioxide batteries, with a service life of up to 10 years, more than double that of conventional batteries.

This is why intelligent luminaires, with energy savings of up to 30% compared to standard LED luminaires.

This is why "SanificaAria", a technology capable of fighting Covid-19 as well as other flu viruses and bacteria, integrated, through a worldwide patent, even into a range of hybrid luminaires for lighting and emergency lighting.

In the years to come we will all have to think differently and act urgently to build a more sustainable future.

We will continue to strive to come up with innovations that help protect the safety of people and the environment in which we live and future generations will live.

## *The Beghelli SavePlanet project*



825.119.000

# emergency

professional  
twenty-one





## Subject index

<b>Systems and luminaires</b> .....	p.002
Control units for self-contained luminaires .....	p.098
Centralised battery systems and control units .....	p.108
Emergency power supply units .....	p.132
Emergency luminaires .....	p.012
Emergency luminaires for wiring systems .....	p.054
Atex emergency luminaires .....	p.062
SanificaAria hybrid luminaires .....	p.068
Architectural Archieco luminaires .....	p.076
Safety signage .....	p.086
Emergency conversion kit .....	p.092
Inibit remote control .....	p.106
<b>Exclusive proposals</b> .....	p.004
Beghelli NuBe cloud .....	p.006
B.Connect .....	p.008
SanificaAria system .....	p.004
Archieco range .....	p.004
Titanium battery .....	p.005
DRM autoripara .....	p.109
Infinity mode .....	p.005
Modulo Orma .....	p.005
<b>Control system guide</b> .....	p.010
<b>Key to symbols</b> .....	p.134
<b>Analytical index</b> .....	p.135
<b>Spare batteries</b> .....	p.140
<b>General terms and conditions of sale</b> .....	p.142

# Luminaire selection guide

✓ Recommended

FAMILY LUMINAIRES EMERGENCY	PAGE	VERSION											MOUNTING						
		Std	AutoTest	Centralised self-testing		CentralTest			Centralised battery			SanificaAria	Orma laser	Archieco	INDOOR	OUTDOOR	RECESSED	503	
		TR	AT	AT-OPT	AT-CBL	LG	LGFM	DALI	LG230	LG24	HT230								
LOGICA	012					✓	✓		✓	✓	✓					✓	✓	✓	
INFINITA INFINITA X5	016				✓	✓	✓	✓	✓	✓	✓	✓				✓	✓	✓	
FORMULA 65	024	✓	✓	✓		✓	✓	✓	✓	✓	✓	✓				✓	✓	✓	
PRATICA	028	✓	✓										✓			✓	✓	✓	
TICINQUE TICINQUE TUTTOLED	032	✓	✓													✓	✓		
UP LED	036	✓		✓		✓	✓	✓								✓	✓		
COMPLETA	038	✓		✓		✓	✓	✓								✓	✓	✓	
STILE IN	042	✓											✓			✓		✓	
METRICA	044					✓	✓	✓	✓	✓	✓					✓	✓	✓	
LUNGALARGA LUCE	046			✓		✓	✓	✓	✓	✓	✓					✓		✓	
MULTI LENS	050	✓		✓		✓	✓	✓	✓	✓	✓					✓		✓	
LUMAX 65	052		✓			✓	✓		✓	✓	✓					✓	✓		
TUTTI FRUTTI, FRUTTOLUCE, LINEA 500	054	✓														✓			✓
BRAIN CLASSIC	060	✓														✓			✓
ACCIAIO	062					✓	✓	✓	✓	✓	✓					✓	✓		
LUNGALARGALUCE EXTREME	064			✓		✓	✓	✓	✓	✓	✓					✓	✓		
NU.DA	076	✓			✓	✓	✓	✓								✓	✓		
DESIGN	078	✓														✓	✓		✓
DOT	080	✓		✓		✓	✓	✓	✓	✓	✓		✓	✓	✓	✓	✓	✓	
ZERO	082	✓		✓		✓	✓	✓	✓	✓	✓					✓	✓		
DESIGN FLAG	084	✓		✓		✓	✓	✓	✓	✓	✓					✓	✓		
IRONFLAG	086	✓		✓		✓	✓	✓	✓	✓	✓		✓			✓	✓		
UP LED BANDIERA IP65	090	✓														✓	✓		
EXIT	088	✓		✓		✓	✓	✓	✓	✓	✓					✓	✓		
INVERTER PLUG&LIGHT	092	✓														✓	✓		
INVERTER LED	094					✓	✓									✓	✓		

## Emergency





# Table of Contents







## SYSTEMS

TR	AT	AT - OPT (OPTICOM)	AT - CBL (CABLECOM)
STANDARD self-contained luminaires with only local diagnostics on battery (Battery Control System)	AUTOTEST self-contained luminaires with full local diagnostics (battery, light source, circuit)	AUTOTEST self-contained luminaires with programmable flow and autonomy (min 1h - max 8hrs) and testing from the dedicated APP. Management from the APP of the system LOGBook. LG - LGFM - DALI expansion modules are available to connect luminaires to the related CENTRALTEST systems.	AUTOTEST self-contained luminaires with programmable flow and autonomy (min 1h - max 8hrs) and testing with dip switch or from the dedicated APP. By integrating the Cablecom Control Unit, without additional wiring, the CENTRALTEST centralised diagnostics control is implemented, including remotely with NuBe CLOUD.
P. 010	P. 010	P. 010	P. 010
STANDARD	AUTOTEST	CENTRALISED SELF-TESTING	

## SUPERVISOR CONTROL UNITS FOR SELF-CONTAINED LUMINAIRES AND NuBe CLOUD

 P. 006	 Cablecom Connect CBL P. 098	 Logica Connect LG, LGFM P. 100	 Logica SD LGFM LGFM, SD P. 104
--	---	---	--



## EMERGENCY

 Logica IP65 LG, LGFM, LG230, LG24, HT230 P. 012	 Infinita X5 IP65 AT-CBL, LG, LGFM, DALI, LG230, LG24, HT230 P. 016	 Formula 65 IP65 TR, AT, AT-OPT, LG, LGFM, DALI, LG230, LG24, HT230 P. 024
 Completa IP66 - IP40 TR, AT-OPT, LG, LGFM, DALI P. 038	 Stile In IP40 TR P. 042	 Metrica IP65 LG, LGFM, DALI, LG230, LG24, HT230 P. 044

## EMERGENCY LUMINAIRES FOR WIRING SYSTEMS

 Tutti Frutti Fruttoluce Linea 500 IP40 TR P. 054	 Placca Brain Classic Emergenza IP20 TR P. 060
--	---



## SanificaARIA - HYBRID LUMINAIRES WITH INTEGRATED AIR SANITIZER

 Stile In SanificaAria IP20 TR P. 068	 Pratica SanificaAria IP20 TR, AT P. 070	 Formula 65 SanificaAria IP20 TR, AT P. 072
--	---	--

## archienco - ARCHITECTURAL LUMINAIRES

 Nu.da IP42 TR, AT-CBL, LG, LGFM, DALI P. 076	 Design IP40 TR P. 078	 Dot ORMA Laser Module IP65 TR, AT-OPT, LG, LGFM, LG24, LG230, DALI, HT230 P. 080
--	---	--

## EXIT SIGNE

 Ironflag IP40 ORMA Laser Module TR, AT-OPT, LG, LGFM, DALI, LG230, LG24, HT230 P. 086	 Exit IP40 TR, AT-OPT, LG, LGFM, DALI, LG230, LG24, HT230 P. 088	 UpLED Bandiera IP65 TR, AT-OPT, LG, LGFM, DALI P. 090
---	---	---

## LG (LOGICA)

AUTOTEST self-contained luminaires with centralised diagnostics and control with LG Control Unit. Even remotely with NuBe CLOUD.



P. 010

## LGFM

Self-contained luminaires with centralised RADIO diagnostics and control with LGFM Control Unit. Even remotely with NuBe CLOUD.



P. 010

## DALI

Self-contained luminaires with centralised DALI diagnostics and control by integrating the optional DALI module.

P. 010

## LG230

Luminaires powered by centralised 216VDC batteries



P. 010

## LG24

Luminaires powered by centralised 24VDC batteries



P. 010

## HT230

Luminaires powered from the mains, the emergency power supply units and the LG230 system.

P. 010

CENTRALTEST

CENTRALISED BATTERY

## CENTRALISED BATTERY AND NuBe CLOUD SYSTEMS

**Logica 230**  
IP40  
IP20  
LG230  
P. 108

**Logica 24**  
Logica 24 Dynamic  
Dynamic luminaires  
IP40  
IP54  
LG24  
P. 120

**Emergency power supply units**  
IP21  
HT230  
P. 132

**Pratica IP65  
Pratica IP42**  
NEW  
IP65 - IP42  
TR, AT  
P. 028

**Ticinque  
Ticinque TuttoLED**  
IP65 - IP42  
TR, AT  
P. 032

**UpLED**  
IP65  
TR, AT-OPT,  
LG, LGFM, DALI  
WARRANTY 10 YEARS  
P. 036

**Lungalargaluce**  
ceiling/recessed  
IP42  
AT-OPT, LG230, LG24,  
HT230, LG, LGFM, DALI  
WARRANTY 10 YEARS  
P. 046

**Multi Lens**  
IP42  
TR, AT-OPT  
LG, LGFM, DALI  
WARRANTY 10 YEARS  
P. 050

**Lumax 65**  
IP65  
AT, LG, LGFM, LG230  
LG24, HT230  
WARRANTY 10 YEARS  
P. 052

## Ex - ATEX EMERGENCY

**Acciaio emergenza**  
IP66  
Ex  
LG, LGFM, LG230, HT230  
P. 062

**Lungalargaluce  
Extreme**  
IP65  
Ex  
AT, AT-OPT, LG, LGFM, DALI,  
LG230, LG24, HT230  
WARRANTY 10 YEARS  
P. 064

**Infinita SanificaAria**  
NEW  
IP20  
SANE  
AT-CBL, LG, LGFM, DALI  
P. 074

**Zero**  
NEW  
IP40  
TR, AT-OPT, LG, LGFM, LG24,  
LG230, DALI, HT230  
WARRANTY 10 YEARS  
P. 082

**Design Flag**  
ORMA Laser Module  
NEW  
IP40  
TR, AT-OPT, LG, LGFM, DALI  
LG230, LG24, HT230  
WARRANTY 10 YEARS  
P. 084

## EMERGENCY CONVERSION KIT

**LED Inverter  
Plug&Light**  
IP65 - IP40  
TR  
P. 092

**LED Inverter**  
IP65 - IP20  
LG, LGFM  
WARRANTY 10 YEARS  
P. 094

# Exclusive Beghelli proposals

emergency



## BEGHELLI NUBE CLOUD, THE RIGHT PLACE FOR YOUR SYSTEMS

**NuBe** is the **Cloud** platform to **access and manage all Beghelli systems**. Available to all Beghelli system installers and users, it allows you to manage and control **both lighting and emergency lighting**, both for self-contained luminaires and for centralised battery luminaires. Among the varied offered services, **predictive maintenance** can be activated, which can anticipate maintenance works on the system to prevent malfunctions.



## B.CONNECT THE GATEWAY TO CENTRALISED SYSTEMS

Single App to manage all control systems of Beghelli self-contained luminaires.

**It allows direct access to the luminaire, to the control unit or to the Beghelli NuBe Cloud platform.** The connection to Beghelli control units is secured, password-protected. The control unit can be easily programmed by reading the unique QR code that can be found on all compatible control units, which recognises the control system (CBL, LG, LGFM) to immediately manage each individual device.

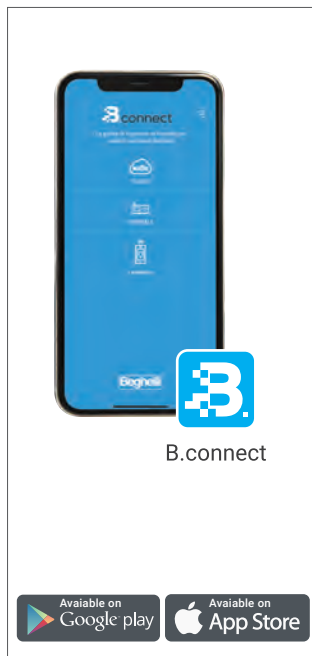

## INTEGRATED AIR SANITIZER IN EMERGENCY LUMINAIRES

Hybrid emergency luminaires with integrated air sanitizer. Thanks to the exclusive **uvOxy® technology** with a closed-chamber UV-C ray flow cell and no ozone emissions, the system eliminates any risk during operation and allows a **continuous sanitisation of rooms in the presence of people**.

Numerous tests, carried out in accredited laboratories, are available online and they certify a **sanitising efficacy of over 99% against Coronavirus and bacteria** far more aggressive than COVID-19.



## PAINTABLE ENVIRONMENTALLY - FRIENDLY DESIGN EMERGENCY LUMINAIRE

The new emergency range for the world of lighting designers.

An innovative concept that makes it possible to **make installed luminaires "disappear" thanks to a surface treatment that allows them to be painted**, even with normal wall paints. In addition, the ArchiEco range maintains a **reduced environmental impact** thanks to the use of completely renewable materials, recycled or biodegradable and compostable raw materials such as PHA, a polymer of organic origin.

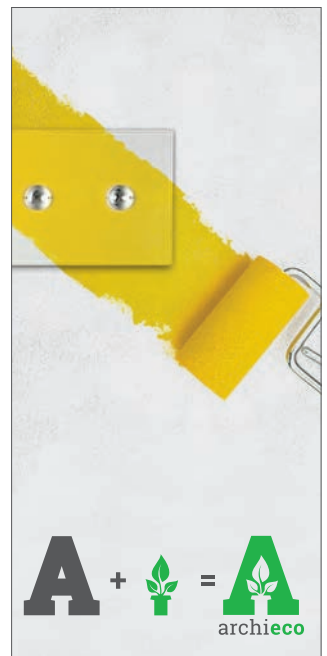



**BATTERY WITH TOP PERFORMANCE GUARANTEED FOR 10 YEARS**

Beghelli uses **Titanium Dioxide (LTO) batteries**, with a maximum efficiency even in extreme environmental and operating conditions. The use of Titanium Dioxide technology in emergency luminaires ensures a unique performance in terms of durability and reliability, first and foremost the **high recharging speed that allows achieving 80% of the autonomy after just 2hrs of recharging**. Emergency luminaires incorporating this technology are covered by a **10-year guarantee**.



**DOUBLE SAFETY FOR 230V CENTRALISED POWER SUPPLY**

DRM Autoripara can be integrated into centrally-powered emergency luminaires (LG230). **In the event of a disaster interrupting the centralised power supply lines, the DRM module takes over from the built-in Titanium battery of the device**. In addition, the **10-year lifespan** of the integrated Titanium battery aligns the luminaires with the testing times of the centralised batteries, thus synchronising maintenance throughout the system.



**INFINITE AUTONOMY, SO AS NOT TO NEVER REMAIN IN THE DARK**

The Infinity Mode can be enabled in all **Cablecom (CBL)** luminaires, either in AutoTest or CentralTest version. Thanks to the CableCom communication BUS, which allows the same cables to be used both for power supply and for data transmission, in the event of a blackout, **when the rated autonomy is over, the CBL Bus will supply the electricity needed to keep the luminaire switched on over an infinite autonomy** (at a reduced flux, power supplied from the CableCom CBL BUS line).



**MODULO ORMA, THE SIGNAGE OF THE FUTURE**

Virtual light pictogram to indicate the nearest escape route on the ground. The system consists of a **laser micro-projector** that emits a bright and prominent arrow-shaped asymmetrical conical beam. The Modulo Orma can be integrated into some of the latest generation of emergency or signage products, providing great flexibility. In fact, to position the light signal on the ground in the correct direction, simply rotate the body of the device.



DEVICE WARRANTY

FAST CHARGING

LONG LIFESPAN, UP TO 7,000 CHARGING CYCLES

MAXIMUM CELL SAFETY IN THE EVENT OF A SHORT CIRCUIT

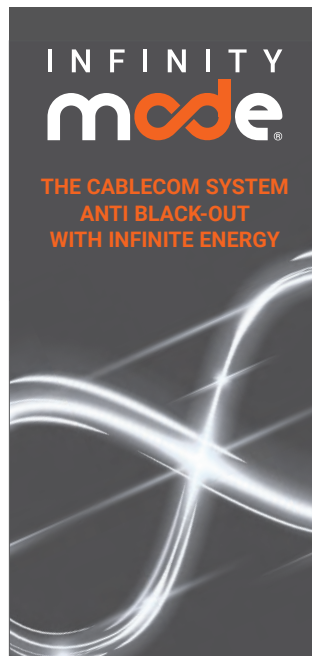

THE CABLECOM SYSTEM  
ANTI BLACK-OUT  
WITH INFINITE ENERGY



005 emergency



# NuBe - the Cloud to manage, control

emergency



## BEGHELLI NUBE CLOUD, THE RIGHT PLACE FOR YOUR SYSTEMS

NuBe is the **Cloud platform to access and manage all Beghelli systems**. Available to all Beghelli system installers and users, it allows you to manage and control **both lighting and emergency lighting**, both for self-contained luminaires and for centralised battery luminaires. Available free of charge in the Basic version or in the Professional version, which further extends the platform's many possibilities, such as **predictive maintenance**. This can anticipate the user's maintenance operations to prevent malfunctions.

### YOUR SYSTEM DATA ARE SAFE AND ALWAYS AVAILABLE



Beghelli devices securely connect to the NuBe platform via end-to-end encryption, which guarantees high security standards.

After login using credentials, an installer will be able to navigate on the platform, with the most up-to-date security, confidentiality and data integrity protocols. Availability of information on the installed systems is guaranteed, and access is possible from any device, from a mobile workstation or from one's own office, with real-time evidence of occurring malfunctions or that still need to be managed. Customers will also be able to access their system, with a less technical and more simplified display of information, adapted to their needs.

Even in the event of a black-out, battery-powered Beghelli control units continue to manage the system, carrying out their work locally. Operation is guaranteed even in the absence of connectivity, the control units autonomously collect data from the system, and they publish local data on the NuBe as soon as the internet connection is restored.

# and archive your systems

## NUBE PRO ADVANCED FEATURES

The NuBe PRO version further extends the features of the portal. There is no longer any limit to the number of control units that can be connected, and therefore the number of luminaires, which can also be from different control systems, both for emergency lighting and lighting (CBL+LG+LGFM+SD). Upgrading to the NuBe PRO version offers access to advanced services such as the insertion of emergency luminaires on photos or room plans, unlimited LogBook history and predictive maintenance capable of anticipating malfunctions, foreseeing the maintenance interventions needed for a correct operation of the system.

NuBe	MAX. NUMBER OF LUMINAIRES PER SYSTEM	* MULTI-SYSTEM MANAGEMENT	SYSTEM AND MAX. NO. OF CONTROL UNITS PER SYSTEM	SYSTEM LOGBOOK HISTORY	PREDICTIVE MAINTENANCE	ROOM PHOTO MANAGEMENT	PLANIMETRY MANAGEMENT	SPARE PART MANAGEMENT	NOTIFICATION MANAGEMENT
NuBe	256		8 x CBL Cablecom alternatively 2 x LG Compact alternatively 1 x LGFM Compact	12 MONTHS					BASIC
NuBe PRO	NO LIMITS	✓	No limit on the no. of CBL Cablecom LG Compact LGFM Compact LGFM SD Logica	NO LIMITS	✓	✓	✓	✓	ADVANCED

\* Option valid both for CB - LG - LGFM emergency control systems and for SD lighting systems



### OVERVIEW

System status with a dynamic live graph, signalling of any faults and access to the latest reports.

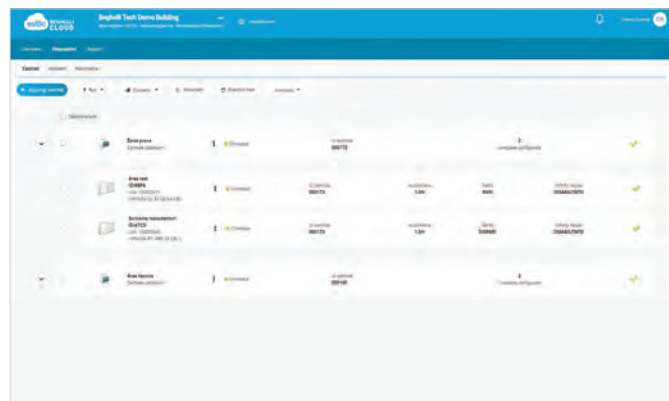

### DEVICES

Tree view of devices (control units and emergency luminaires) with a description of their current status.

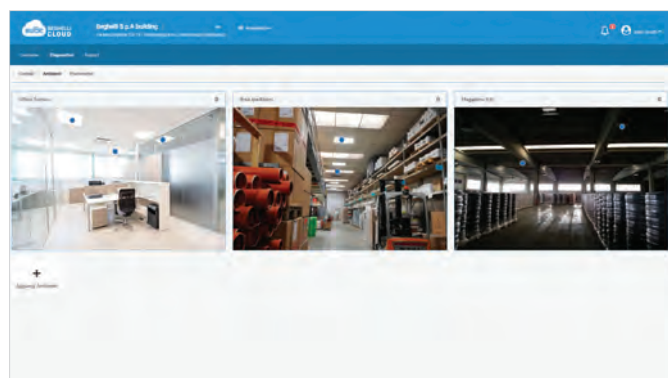

### ENVIRONMENTS

Positioning of luminaires on existing room photos (by drag and drop onto the photo in the desired position).



### PLANIMETRY

Positioning of devices on floor plans (by drag and drop onto the photo in the desired position).



# A single APP to manage all your systems

emergency

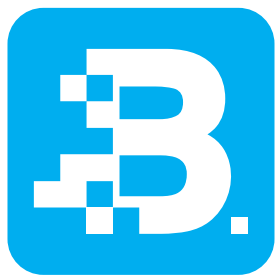

## B.connect

Single App to manage all control systems of Beghelli self-contained luminaires. **It allows direct access to the luminaire, to the control unit or to the Beghelli NuBe Cloud platform.** The connection with Beghelli control units is secured, password-protected, and it can be made by reading the QR code found on all compatible control units.

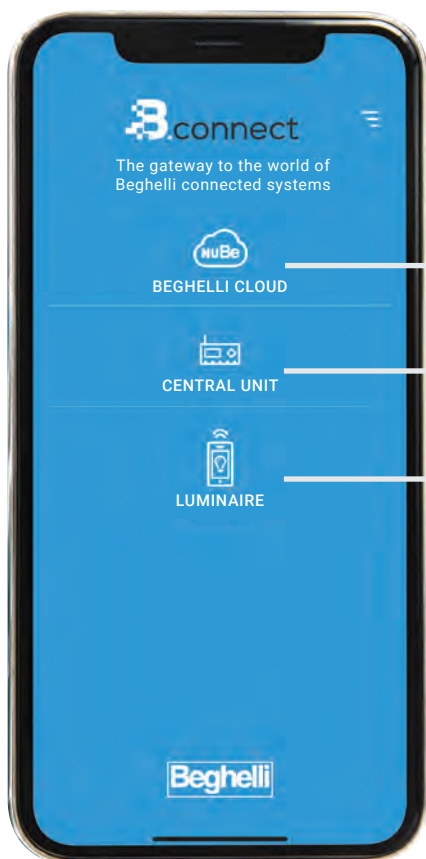

### ACCESS TO THE SYSTEM THROUGH THE BEGHELLI CLOUD

The APP allows direct access to the NuBe platform. All programming, remote control and system logbook view functions become available immediately.

NuBe stores all configurations of all systems and makes them always available on your smartphone.



### ACCESS TO THE SYSTEM THROUGH DIRECT COMMUNICATION WITH THE CONTROL UNIT

B.connect is designed for a direct reading of the QR code of the control unit, which will detect the identification of the device and will also recognise the type of control system (CBL, LG, LGFM). After logging in, the main control and management functions of the entire system will already be available. The system uses local WiFi technology that does not require an internet connection.

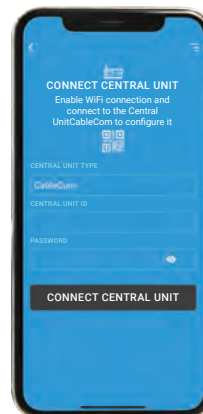

### DIRECT ACCESS TO THE EQUIPMENT THROUGH OPTICAL COMMUNICATION

In this mode, it is possible to directly communicate with the luminaires via the smartphone flash. A patented communication technology that allows light impulses to be transmitted to luminaires that have an intelligent light sensor. The commands that can be set are for programming lamp parameters and conducting functional tests as well as the management of the sanitisation system integrated in the hybrid luminaires of the SanificaAria series.

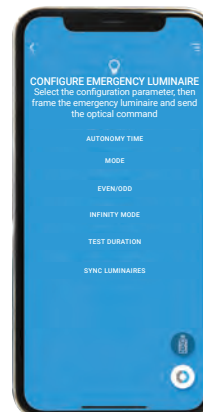

# Systems, both remotely and locally

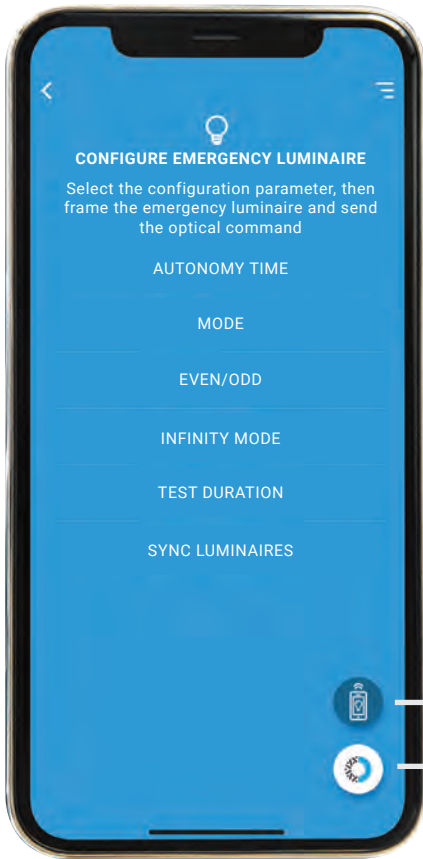

## LAMP TEST

B.connect can enable all functional and autonomy tests required by current emergency lighting regulations. The commands are transmitted directly from the smartphone to each individual luminaire equipped with an intelligent light sensor.

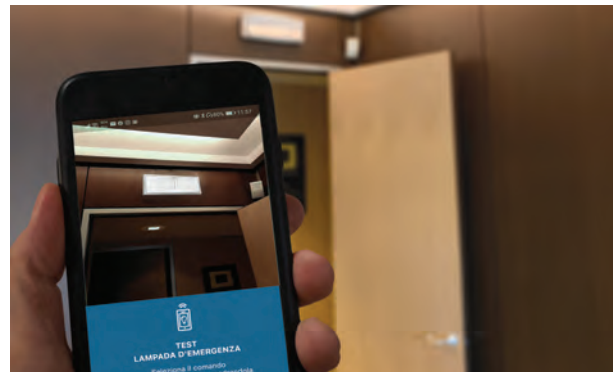
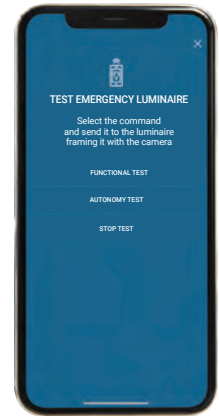

Optical communications between the smartphone flash and the intelligent light sensor integrated in compatible emergency luminaires



## AIR SANITISATION

The speed-adjustable luminaires of the SanificaAria series are provided with an intelligent light sensor that can receive light commands transmitted from the B.Connect App via the smartphone flash. This mode allows you to enable or disable the sanitising process, to set the speed of the fans that introduce air into the uvOxy® sanitising cell and to manage the sanitising times according to the environment and the requirements.



# Guide to control systems

emergency

## FROM LOCAL DIAGNOSTICS TO SELF-DIAGNOSIS WITH CENTRALISED CONTROL

Beghelli emergency luminaires always comply with EN 50171, EN 50172, EN 62040-1-1, EN 62040-2, and are available in different control modes. **TR** means luminaires in standard version with local battery control, **AT** are luminaires with local diagnostics of all luminaire functions; in the **AT-OPT** (AutoTest Opticom) and **AT-CBL** (AutoTest Cablecom) versions, modules (to be ordered separately) can be integrated into the luminaire for connection to **LG** (Logica), **LGFM** (Logica radio FM) and **DALI** centralised systems. Luminaires are also available in Centratest mode, to be used in conjunction with the **CBL** (Cablecom), **LG**, **LGFM**, **LG24** (Logica 24V) and **LG230** (Logica 230V) control units.

SYSTEM	SELF-DIAGNOSTICS	CENTRALISED POWER SUPPLY	CENTRALISED CONTROL	MAX. NUMBER OF LUMINAIRES	BUS	RADIO	POWER SUPPLY VOLTAGE	APP LOCAL	CLOUD		POSSIBILITIES FOR EXPANSION	CONTROL UNIT Order Code
									NUBE	NUBE PRO		
<b>TR</b>							230VAC					-
<b>AT</b>	✓						230VAC					-
<b>AT-OPT</b>	✓						230VAC	✓			<b>LG, LGFM, DALI</b>	-
<b>AT-CBL</b>	✓		✓	32/Infinite*			230VAC	✓	✓		<b>LG, LGFM, DALI</b>	20151
<b>LG</b>	✓		✓	Up to 128/3968**	✓		230VAC	✓	✓			12100C
<b>LGFM</b>	✓		✓	256 (12128C) 996 (21102)		✓	230VAC	✓	✓			12128C 21102
<b>DALI</b>	✓		✓	Up to 64	✓		230VAC	✓	✓			12100C
<b>LG230</b>	✓	✓	✓	3072			230VAC/216VDC			✓		See p. 108
<b>LG24</b>	✓	✓	✓	256			24VDC			✓		See p. 120
<b>HT230</b>		✓					230VAC/216VDC					-

\* Each system connected to the NuBe Cloud can manage an infinite number of control units and, therefore, of luminaires. In particular, with the CBL control units, large-scale systems can be implemented with ease  
 \*\* By integrating the Supervisor Control Unit Order Code 12131C, up to 3968 devices can be connected (128 luminaires x 31 LG Logica control units)

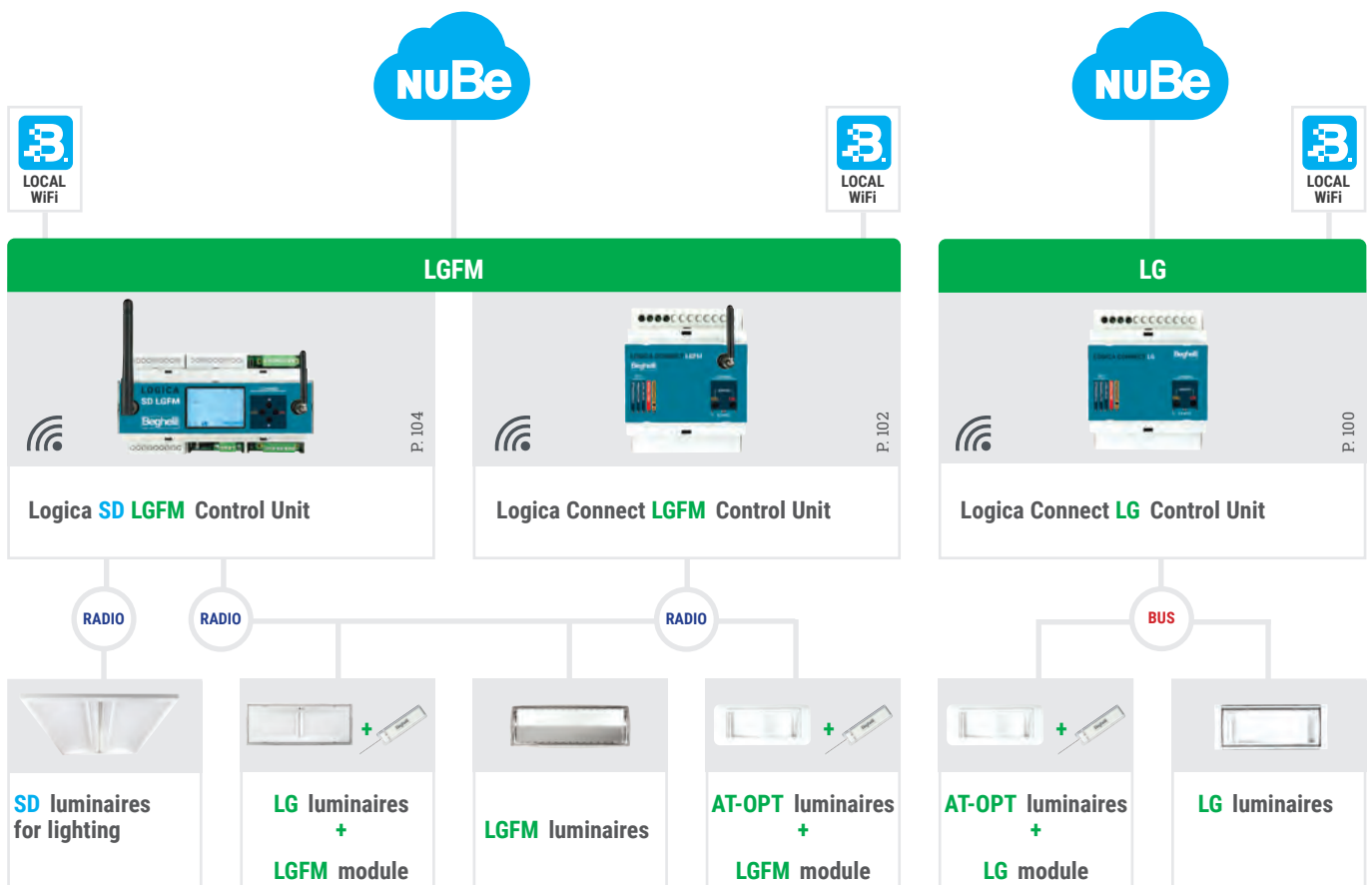

## CENTRALTEST, SELF-CONTAINED LUMINAIRES

**CBL** (Cablecom) is the easiest way to centralise the control and diagnosis of emergency systems, thanks to its innovative data transmission system that directly uses the emergency power lines without adding a dedicated BUS line. **LG** (Logica) is an advanced management system for the entire emergency system, requiring a dedicated BUS line, but offering best-in-class possibilities. If maximum performance is required, but it is not possible to insert a dedicated BUS line, **LGFM** (Logica Radio FM) allows the management of the entire emergency system via radio, without additional wiring.

## CENTRALTEST, CENTRALISED BATTERY LUMINAIRES

When the need arises for a centralised battery control system, **LG230** (Logica 230V) makes it possible to create even large systems that are perfectly manageable thanks to the wide range of accessory emergency power supply units that allow expansion and splitting. For smaller systems, **LG24** (Logica 24V) is ideal. It uses 24VDC to power the devices, guaranteeing extreme safety in all fields of application, thanks to the low operating voltage of the dedicated power lines. The systems are complementary and can be integrated into the same overall system.

## SINGLE INTERFACE FOR CENTRALISED SYSTEMS

All Beghelli systems use the **B.connect APP** for the local programming of main parameters.

From the same APP, you can connect to the **NuBe Cloud Portal**, where luminaire management and system programming is more advanced and can also be done remotely.

NuBe is not only a WEB portal for the control and management of Beghelli systems, but it also allows cloud storage of system data.

The centralised battery systems, equipped with a touch screen and WEB connection, can be connected to NuBe even without the **B.connect APP**.

**NUBe PRO** ALLOWS THE AGGREGATION OF SEVERAL CONTROL UNITS, EVEN FROM DIFFERENT SYSTEMS. IT OPERATES AS A SINGLE SUPERVISOR CONTROL UNIT THAT CAN MANAGE AN INFINITE NUMBER OF CONTROL UNITS AND THEREFORE LUMINAIRES, INCLUDING LIGHTING.

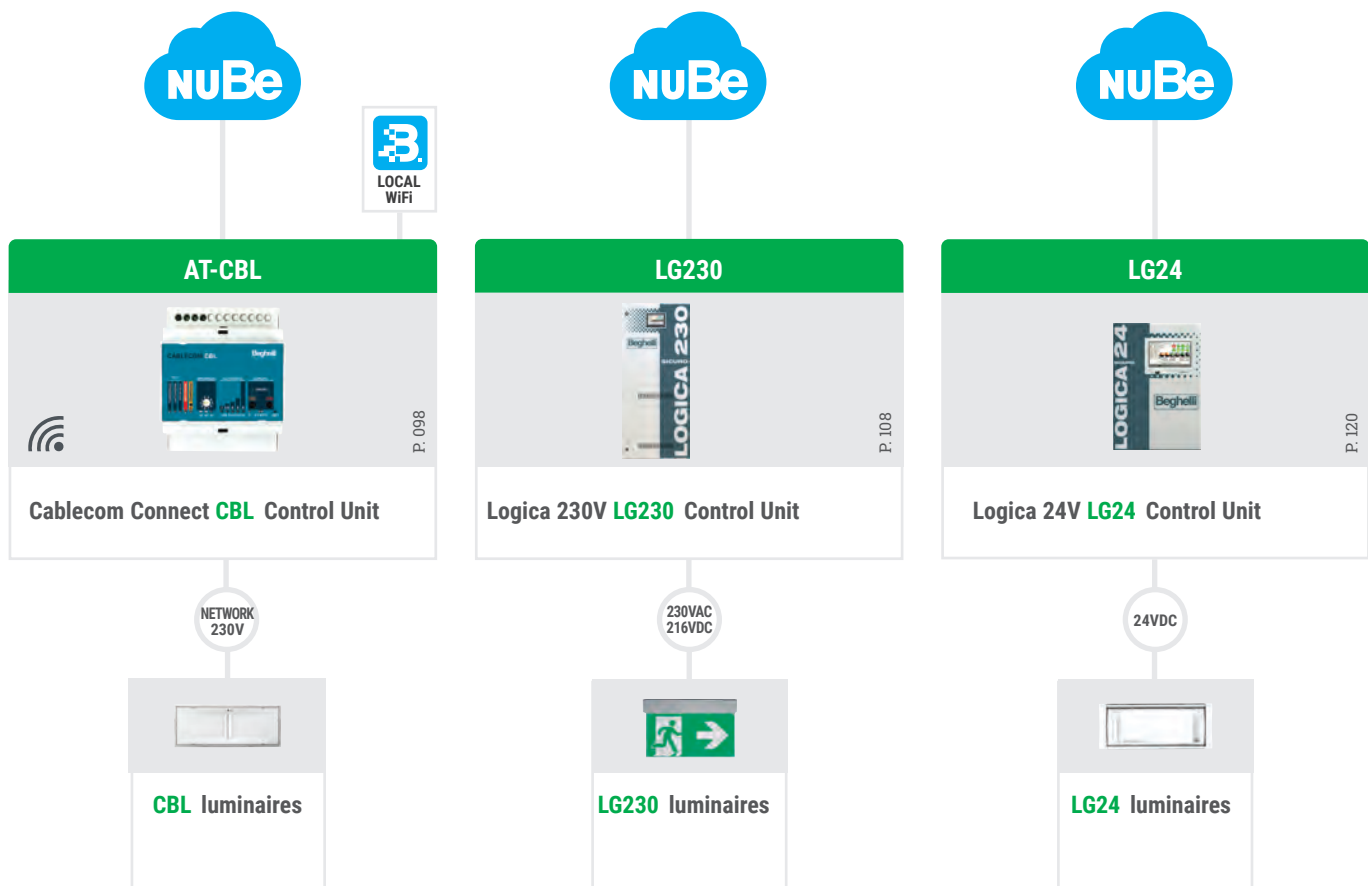



IP65

IK07

850°



Batt. LTO

+45°C  
-20°C

Batt. NiMH

+40°C  
0°C

Batt. Pb

+40°C  
0°C



Luminous flux up to **2,000 lm**, and adjustable autonomy.

Fast-charging **Titanium battery**, with 10 years of service life and for extreme working temperatures.



Great flexibility thanks to multiple versions and accessories for all installation requirements. Pictograms supplied.



**Quick-fit bracket** with level bubble to speed up correct positioning, mounting and maintenance time.

## Applications

Industry, Services, Hospitals, Schools, Hotels, Restaurants

## Characteristics

**Power supply\*** 230VAC ± 10%, 50÷60Hz

**Mounting** Wall, ceiling, recessed, false ceiling

**Recharging time** 12h with LTO battery

**Housing** Polycarbonate, white RAL 9003

**Optics** Symmetrical, anti-glare metallic polycarbonate

**Screen** Clear polycarbonate

**Compliance** EN 60598-1, EN 60598-2-2, EN 60598-2-22, UNI EN 1838, UNI 11222, EN 62034

\* LG230, LG24, HT systems consider the parameters of the control unit used

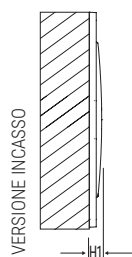

Version	Dimensions mm				Distance of visibility (DV)
	L	B	H	H1	
Standard	406	147	63	-	20m
Recessed	440	170	-	10	20m

## Performance according to EN 1838

Height (m)	Centre distance (m) ESCAPE ROUTES		Illuminated surface area (m) LARGE AREAS	
	Wall	Ceiling	Wall	Ceiling
2.5	11	-	6x9	-
3	-	19	-	10x16
7	-	28	-	12x26

Lighting >1lx at floor level along the centre line without reflections Emax/Emin <40

Lighting >0.5lx at floor level without reflections Emax/Emin <40

Performance with reference to luminaire Order Code 19410 1100 lm

Maintenance coefficient 0.8



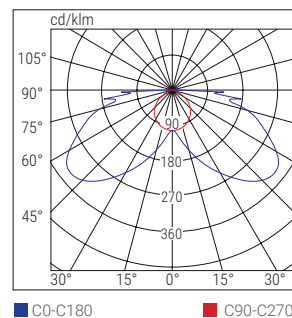



## LOGICA











	Order Code	W eq.	Description	Version	Autonomy h	Battery	FLUX SE lm	Batt. AUTORIPARA SUPPLIED Flux SE lm	FLUX SA lm		Input power		Weight Kg	Packaging Single/ Multi pack	Conform.
									DC	AC	DC	AC			
LG	12182	8	LOG LED LG 8W SE 2/4/6H	SE	2/4/6	Pb 6V 4Ah	750/450/350		-		4W	2.2	1/6		CENTRALTEST
	12185	8	LOG LED LG 8W SA/PS 2/4/6H	SA/SE/PS	2/4/6	NiMh 7.2V 2.5Ah	750/450/350		400		8W	2.2	1/6		
	12183	11	LOG LED LG 11W SE 1.5/3/4H	SE	1.5/3/4	Pb 6V 4Ah	900/550/450		-		4W	2.2	1/6		
	12186	11	LOG LED LG 11W SA/PS 1.5/3/4H	SA/SE/PS	1.5/3/4	NiMh 7.2V 2.5Ah	900/550/450		500		10W	2.2	1/6		
	12184	24	LOG LED LG 24W SE 1/2/3H	SE	1/2/3	Pb 6V 4Ah	1100/750/550		-		6W	2.2	1/6		
	12187	24	LOG LED LG 24W SA/PS 1/2/3H	SA/SE/PS	1/2/3	NiMh 7.2V 2.5Ah	1100/750/550		600		14W	2.2	1/6		
	19410	36	LOGICA LED LTO LGAR SE 1100LM	SE	1/1.5/3*	LTO 9.6V 1.2Ah	➔	2000/1500/800			7W	2.2	1/6		
	19411	36	LOGICA LED LTO LGAR SA 1100LM	SA/SE/PS	1/1.5/3*	LTO 9.6V 1.2Ah	➔	2000/1500/800	1000		13W	2.2	1/6		
LGM	12182FM	8	LOG LED LGM 8W SE 2/4/6H	SE	2/4/6	Pb 6V 4Ah	750/450/350		-		5W	2.2	1/6		CENTRALISED BATTERY
	12185FM	8	LOG LED LGM 8W SA/PS 2/4/6H	SA/SE/PS	2/4/6	NiMh 7.2V 2.5Ah	750/450/350		400		9W	2.2	1/6		
	12183FM	11	LOG LED LGM 11W SE 1.5/3/4H	SE	1.5/3/4	Pb 6V 4Ah	900/550/450		-		5W	2.2	1/6		
	12186FM	11	LOG LED LGM 11W SA/PS 1.5/3/4H	SA/SE/PS	1.5/3/4	NiMh 7.2V 2.5Ah	900/550/450		500		11W	2.2	1/6		
	12184FM	24	LOG LED LGM 24W SE 1/2/3H	SE	1/2/3	Pb 6V 4Ah	1100/750/550		-		7W	2.2	1/6		
	12187FM	24	LOG LED LGM 24W SA/PS 1/2/3H	SA/SE/PS	1/2/3	NiMh 7.2V 2.5Ah	1100/750/550		600		15W	2.2	1/6		
LG230	31140	8	LOGICA LED 8W LG230						400	4.1W	8.5VA	1.4	1/6		CENTRALISED BATTERY
	31141	11	LOGICA LED 11W LG230 LS-UV						500	6.4W	8.1VA	1.8	1/6		
	31099	24	LOGICA LED 24W LG230 LS-UV						900	10.4W	12VA	1.8	1/6		
	31120	36	LOGICA LED 36W LG230 LS-UV						1400	15W	15.9VA	1.8	1/6		
LG24	32096	8	LOGICA LED 8W LGS24				400		400	3.8W	-	1.8	1/6		CENTRALISED BATTERY
	32089	36	LOGICA LED 36W LGS24 LS-UV				400		1400	4.3W	15.4VA	1.8	1/6		
HT230	17403	8	LOGICA LED 8W HT						400	4.4W	8.9VA	1.4	1/6		CENTRALISED BATTERY
	17404	11	LOGICA LED 11W HT						550	6.1W	6.4VA	1.8	1/6		
	17405	24	LOGICA LED 24W HT						900	10.2W	10.4VA	1.8	1/6		
	17406	36	LOGICA LED 36W HT						1400	14.3W	14.5VA	1.8	1/6		

\* The indicated flux and autonomy refer to the luminaire set in HIGH FLUX mode - with the LONG OPERATING TIME setting, the autonomy doubles and the flux is reduced.

## ACCESSORIES - included

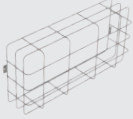
	<p><b>AR LTO 9.6V 1.2Ah BATTERY SYSTEM</b> Compatible with Order Code <b>19410 - 19411</b></p> <p>Order Code <b>RA04</b> - LTO 9.6V 1.2Ah</p>		<p><b>RH SCREEN</b> - SA version only Screen printing on opal polycarbonate</p> <p>Order Code <b>12175</b></p>
	<p><b>CABLE CONDUIT GLAND</b></p>		<p><b>LH SCREEN</b> - SA version only Screen printing on opal polycarbonate</p> <p>Order Code <b>12176</b></p>
	<p><b>QUICK WALL MOUNTING BRACKET IP65</b></p> <p>Order Code <b>12199</b></p>		<p><b>DOWN SCREEN</b> - SA version only Screen printing on opal polycarbonate</p> <p>Order Code <b>12177</b></p>

## ACCESSORIES - to be ordered separately

	<p><b>RECESSED FRAME BOX</b></p> <p>Order Code <b>12179</b></p>		<p><b>UP SCREEN</b> Screen printing on opal polycarbonate</p> <p>Order Code <b>12178</b></p>
	<p><b>FALSE CEILING BRACKET</b> Recess hole 414X150 mm</p> <p>Order Code <b>12180</b></p>		<p><b>RH SCREEN</b> Screen printing on opal polycarbonate</p> <p>Order Code <b>12175</b></p>
	<p><b>PROTECTIVE GRILLE</b> Dimensions 440x215x99 mm</p> <p>Order Code <b>3912</b></p>		<p><b>LH SCREEN</b> Screen printing on opal polycarbonate</p> <p>Order Code <b>12176</b></p>
	<p><b>LG INIBIT REMOTE CONTROL</b> RM for LG versions only</p> <p>Order Code <b>12101</b></p>		<p><b>DOWN SCREEN</b> Screen printing on opal polycarbonate</p> <p>Order Code <b>12177</b></p>

LG





# Infinita

emergency



Batt. LTO



Luminous flux up to **1700lm** and **infinite autonomy** (reduced flux) with the **Infinity mode**.

Fast-charging **Titanium battery**, with 10 years of service life and for extreme working temperatures.



Optimum performance for both wall and ceiling mounting with installation distances of up to 34m.



Numerous pre-drilled inlets and connection accessories.

## Applications

Industry, services

## Characteristics

**Power supply\*** 230VAC ± 10%, 50-60Hz

**Mounting** Wall, ceiling, recessed, false ceiling, wall/ceiling edge mounting, suspended, suspended on rods

**Recharging time** 12h

**Housing** Polycarbonate, white RAL 9003

**Optics** PMMA, Total Internal Reflection

**Screen** Clear polycarbonate

**Compliance** EN 60598-1, EN 60598-2-2, EN 60598-2-22, UNI EN 1838, UNI 11222, EN 62034

\* LG230, LG24, HT systems consider the parameters of the control unit used

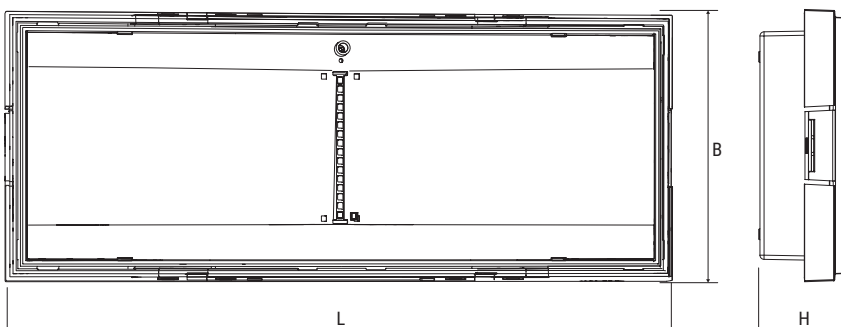

Dimensions mm			Distance of visibility (DV)
L	B	H	
325	130	45	25m

## Performance according to EN 1838

Height (m)	Centre distance (m) ESCAPE ROUTES		Illuminated surface area (m) LARGE AREAS	
	Wall	Ceiling	Wall	Ceiling
2.5	14	-	8x9	-
3	-	20	-	10x16
7	-	20	-	15x15
Lighting >1lx at floor level along the centre line without reflections Emax/Emin <40			Lighting >0.5lx at floor level without reflections Emax/Emin <40	
Performance with reference to luminaire Order Code 19460 1000 lm			Maintenance coefficient 0.8	

## INFINITA

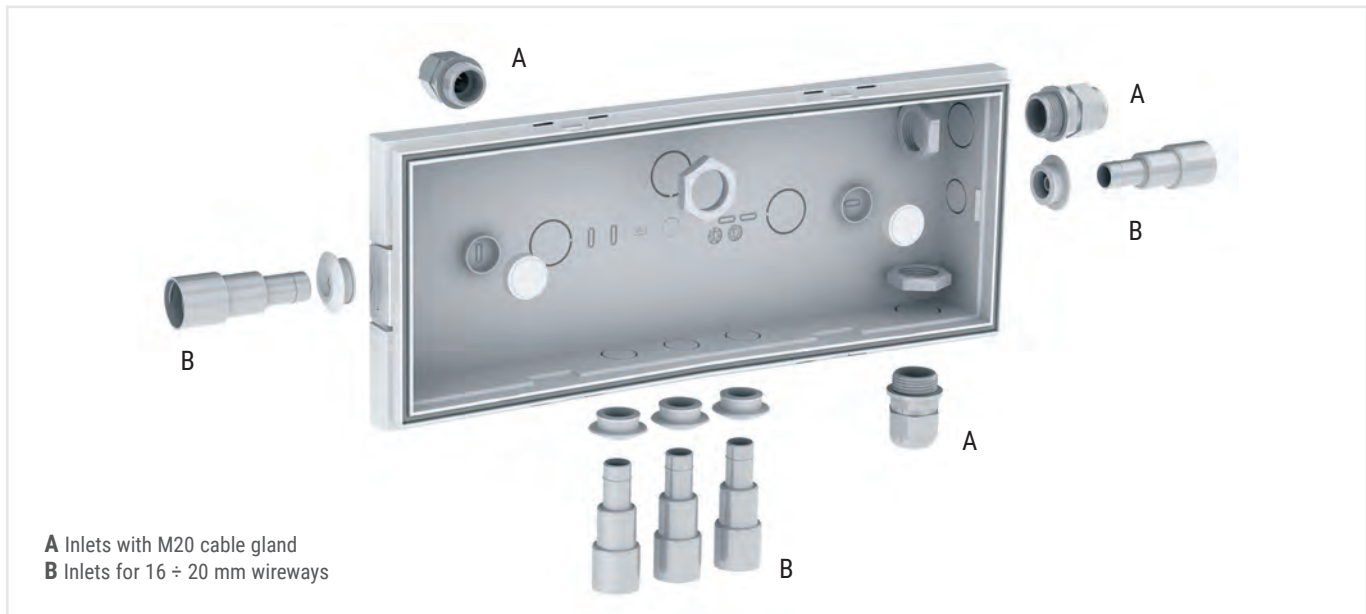
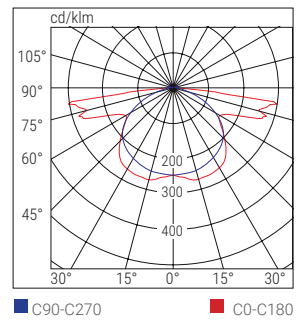



	Order Code	W eq.	Description	Version	Autonomy h	Battery	FLUX SE lm	Batt. AUTORIPARA SUPPLIED Flux SE lm	FLUX SA lm		Input power		Weight Kg	Packaging Single/ Multi pack	Conform.	
									DC	AC	DC	AC				
AT-CBL	19450	11	INFINITA RTI IP65 SE CBL LTO L	SE	1/1.5/ 2/3/8	4.8V 0.5Ah LTO	250/170/130/90/40	-			1W	0.6	1/6	CENTRALISED SELF-TESTING		
	19451	24	INFINITA RTI IP65 SE CBL LTO XL	SE	1/1.5/2/3/8	4.8V 1.2Ah LTO	500/340/260/180/70	-		2.6W	0.6	1/6				
	19452	11	INFINITA RTI IP65 SA CBL LTO L	SA/SE	1/1.5/2/3/8	4.8V 0.5Ah LTO	250/170/130/90/40	-	90	1.8W	0.6	1/6				
	19453	24	INFINITA RTI IP65 SA CBL LTO XL	SA/SE	1/1.5/2/3/8	4.8V 1.2Ah LTO	500/340/260/180/70	-	250	4.8W	0.6	1/6				
	19454	24*	INFINITA RTI SE CBL LTO XL 700lm	SE	1/1.5/2/3/8	4.8V 1.2Ah LTO	700/500/400/250/100	-		2.6W	0.6	1/6				
	19455	24*	INFINITA RTI SA CBL LTO XL 700lm	SA/SE	1/1.5/2/3/8	4.8V 1.2Ah LTO	700/500/400/250/100	-	250	4.8W	0.6	1/6				
	19460	36	INFINITA GL RTI SA/SE CBL LTO	SA/SE	1/1.5/2/3/8	2x4.8V 1.2Ah LTO	1000/680/525/370/145	-	250	4.8W	0.6	1/6				
LG	19470	36	INFINITA ULTIMATE RTI SA/SE LTO	SA/SE/PS	1/1.5/3*	9.6V 1.2Ah LTO		1700/1150/620	850	13W	0.6	1/6	CENTRALISED TEST			
			<b>LGFM</b>	Standalone luminaires with Centralised Radio Diagnostics integrating the Module Order Code 15037												
				<b>DALI</b>	Standalone luminaires with Dali Centralised Diagnostics integrating the Module Order Code 15038											
LG230	31170	11	INFINITA RTI LGS230 SA/SE L						500	4.5W	8.6VA	0.6	1/6	CENTRALISED BATTERY		
	31171	24	INFINITA RTI LGS230 SA/SE XL						1500	15.1W	16.3VA	0.6	1/6			
LG24	32110	11	INFINITA RTI LGS24 SE L						500	3.9W	-	0.6	1/6	CENTRALISED BATTERY		
	32111	24	INFINITA RTI LGS24 SA/SE XL						1500	4.3W	16.1VA	0.6	1/6			
HT230	31174	11	INFINITA RTI HT L						500	4.5W	9VA	0.6	1	CENTRALISED BATTERY		
	31175	24	INFINITA RTI HT XL						1500	15.1W	16.1VA	0.6	1			

\* The indicated flux and autonomy refer to the luminaire set in HIGH FLUX mode - with the LONG OPERATING TIME setting, the autonomy doubles and the flux is reduced.











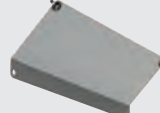

# Infinita

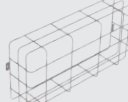
emergency

## ACCESSORIES - included

	<p><b>AR LTO 9.6V 1.2Ah BATTERY SYSTEM</b> Compatible with Order Code <b>19470</b></p> <p>Order Code <b>RA04</b></p>		<p><b>CONDUIT ADAPTER 16/20 mm WHITE</b> Mounting with a Ø16 or Ø20 mm conduit</p>
	<p><b>CABLE GLAND M20 WITH VENT</b></p>		<p><b>5-POLE FEED-THROUGH WIRING</b> HT230 versions only</p> <p>Order Code <b>20155</b></p>
	<p><b>CABLE GLAND MEMBRANE M16 IP65</b></p>		<p><b>LH/RH/DOWN/UP STICKERS</b> (included for SA versions only)</p> <p>Order Code <b>4682</b></p>

## ACCESSORIES - to be ordered separately

	<p><b>EDGE MOUNTING SCREEN 25M</b></p> <p>Order Code <b>4681</b></p>		<p><b>45° BRACKET</b></p> <p>Order Code <b>4685</b></p>
	<p><b>RECESSED LED BOX</b></p> <p>Order Code <b>4683</b></p>		<p><b>SUSPENDED MOUNTING RODS</b> 250 - 500 - 1000 mm Order Code <b>4315</b> (250 mm) - <b>4316</b> (500 mm) <b>4317</b> (1000 mm)</p>
	<p><b>PLASTERBOARD RECESSED MOUNTING BRACKET</b></p> <p>Order Code <b>4687</b></p>		<p><b>PROTECTIVE GRILLE</b> 440x215x99 mm</p> <p>Order Code <b>3912</b></p>
	<p><b>EDGE MOUNTING FIXING BRACKET</b></p> <p>Order Code <b>4686</b></p>		<p><b>SUSPENDED MOUNTING HOOKS</b></p> <p>Order Code <b>3723</b></p>
	<p><b>5-POLE FEED-THROUGH WIRING</b> For all versions except LG</p> <p>Order Code <b>20155</b></p>		<p><b>LGFM MODULE</b> LG versions only</p> <p>Order Code <b>15037</b></p> <p><b>LGFM</b></p>
	<p><b>7-POLE FEED-THROUGH WIRING</b> LG versions only</p> <p>Order Code <b>20156</b></p>		<p><b>DALI MODULE</b> LG versions only</p> <p>Order Code <b>15038</b></p> <p><b>DALI</b></p>
	<p><b>LG INIBIT REMOTE CONTROL</b> RM for LG versions only</p> <p>Order Code <b>12101</b></p> <p><b>LG</b></p>		





# Infinita X5

emergency



- Luminous flux up to **1500lm** and infinite autonomy (reduced flux) with the **Infinity mode**. Fast-charging **Titanium battery**, with 10 years of service life and for extreme working temperatures.
- Optimum performance for ceiling mounting, either at **7m** or **12m**, with installation distances of up to 34m.
- Optical system with 5 interchangeable lenses to adapt the area of intervention to the need for both anti-panic areas and escape routes.
- Numerous pre-drilled inlets and connection accessories.

## Applications

Industry, services, high-risk areas

## Characteristics

**Power supply\*** 230VAC  $\pm$  10%, 50÷60Hz

**Mounting** Wall, ceiling, recessed, false ceiling, suspended, suspended with rods

**Recharging time** 12h

**Housing** Polycarbonate, white RAL 9003

**Optics** Clear polycarbonate lenses

**Screen** Clear polycarbonate

**Compliance** EN 60598-1, EN 60598-2-2, EN 60598-2-22, UNI EN 1838, UNI 11222, EN 62034

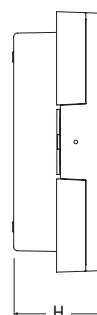
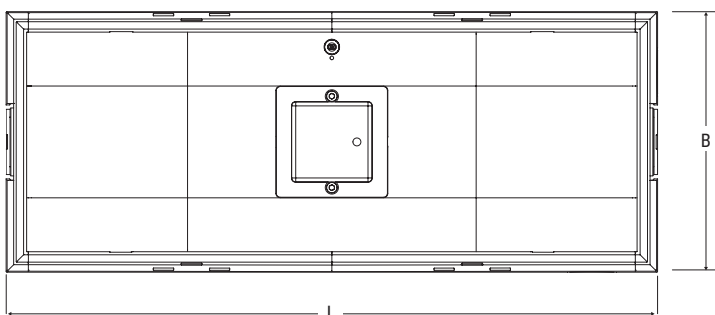

\* LG230, LG24, HT systems consider the parameters of the control unit used



Dimensions mm		
L	B	H
325	130 152	45

020

## Reference standard UNI EN 1838

Lens	Height (m) 	Centre distance (m) ESCAPE ROUTES 		Illuminated surface area (m) LARGE AREAS 	
		Wall	Ceiling	Wall	Ceiling
Lungaluce 3m	3	-	11	-	-
Lungaluce 7m	7	-	28	-	-
Largaluce 3m	3	-	-	-	7X7
Largaluce 7m	7	-	-	-	20x20
High risk	7	-	-	-	Ø3m - 30lx

Lighting >1lx at floor level along the centre line without reflections Emax/Emin <40

Lighting >0.5lx at floor level without reflections Emax/Emin <40

Performance with reference to luminaire Order Code 19461 900lm

Maintenance coefficient 0.8

HIGH RISK

87%

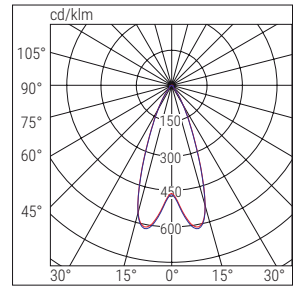

### LUNGALUCE 3m 85%

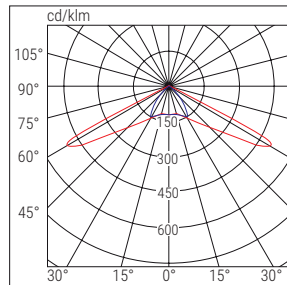

■ C0-C180 ■ C90-C270

### LUNGALUCE 7m 85%

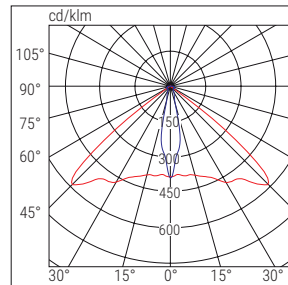

■ C0-C180 ■ C90-C270

### LARGALUCE 3m 90%

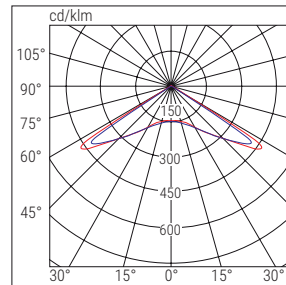

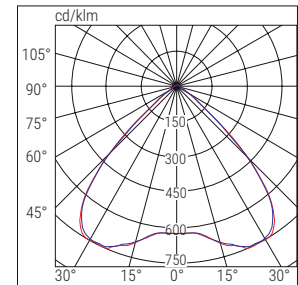

■ C0-C180 ■ C90-C270

### LARGALUCE 7m 87%



■ C0-C180 ■ C90-C270

	Order Code	W eq.	Description	Version	Autonomy h	Battery	FLUX SE lm	Batt. AUTORIPARA SUPPLIED Flux SE lm	FLUX SA lm	Input power		Weight Kg	Packaging Single/ Multi pack	Conform.	
										DC	AC				
AT-CBL	19461	24GL	INFINITA GL 5X SA/SE CBL LTO	SA/SE	1/1.5/2/3/8	2x4.8V 1.2Ah LTO	900/600/470/330/130		250		4.8W	0.6	1/6		
	LG	19471	36	INFINITA ULTIMATE 5X SA/SE LTO	SA/SE/PS	1/1.5/3*	2x9.6V 1.2Ah LTO		1500/1000/550	700		13W	0.6	1/6	
		<b>LGFM</b>	Standalone luminaires with Centralised Radio Diagnostics integrating the Module Order Code 15037												
	<b>DALI</b>	Standalone luminaires with Dali Centralised Diagnostics integrating the Module Order Code 15038													
LG230	31172	24	INFINITA 5X LGS230 SA/SE XL						1100	11.4W	12.4VA	0.6	1/6		
LG24	32112	24	INFINITA 5X LGS24 SA/SE XL				500		1100	4.3W	11.4VA	0.6	1/6		
HT230	31176	24	INFINITA 5X HT XL				-		1100	10.5W	10.8VA	0.6	1/6		

\* The indicated flux and autonomy refer to the luminaire set in HIGH FLUX mode - with the LONG OPERATING TIME setting, the autonomy doubles and the flux is reduced.









NEXT >









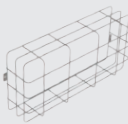

# Infinita X5

emergency

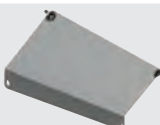
## ACCESSORIES - included

	<p><b>AR LTO 9.6V 1.2Ah BATTERY SYSTEM</b> Compatible with Order Code <b>19471</b></p> <p>Order Code <b>RA04</b></p>		<p><b>HIGH RISK LENS</b></p>
	<p><b>CABLE GLAND MEMBRANE M16 IP65</b></p>		<p><b>LUNGALUCE LENS 3m</b></p>
	<p><b>CONDUIT ADAPTER 16/20 mm WHITE</b> Mounting with a Ø16 or Ø20 mm conduit</p>		<p><b>LUNGALUCE LENS 7m</b></p>
	<p><b>5-POLE FEED-THROUGH WIRING</b> HT230 versions only</p> <p>Order Code <b>20155</b></p>		<p><b>LARGALUCE LENS 3m</b> Fitted as standard</p>
			<p><b>LARGALUCE LENS 7m</b></p>

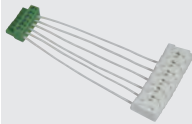
## ACCESSORIES - to be ordered separately

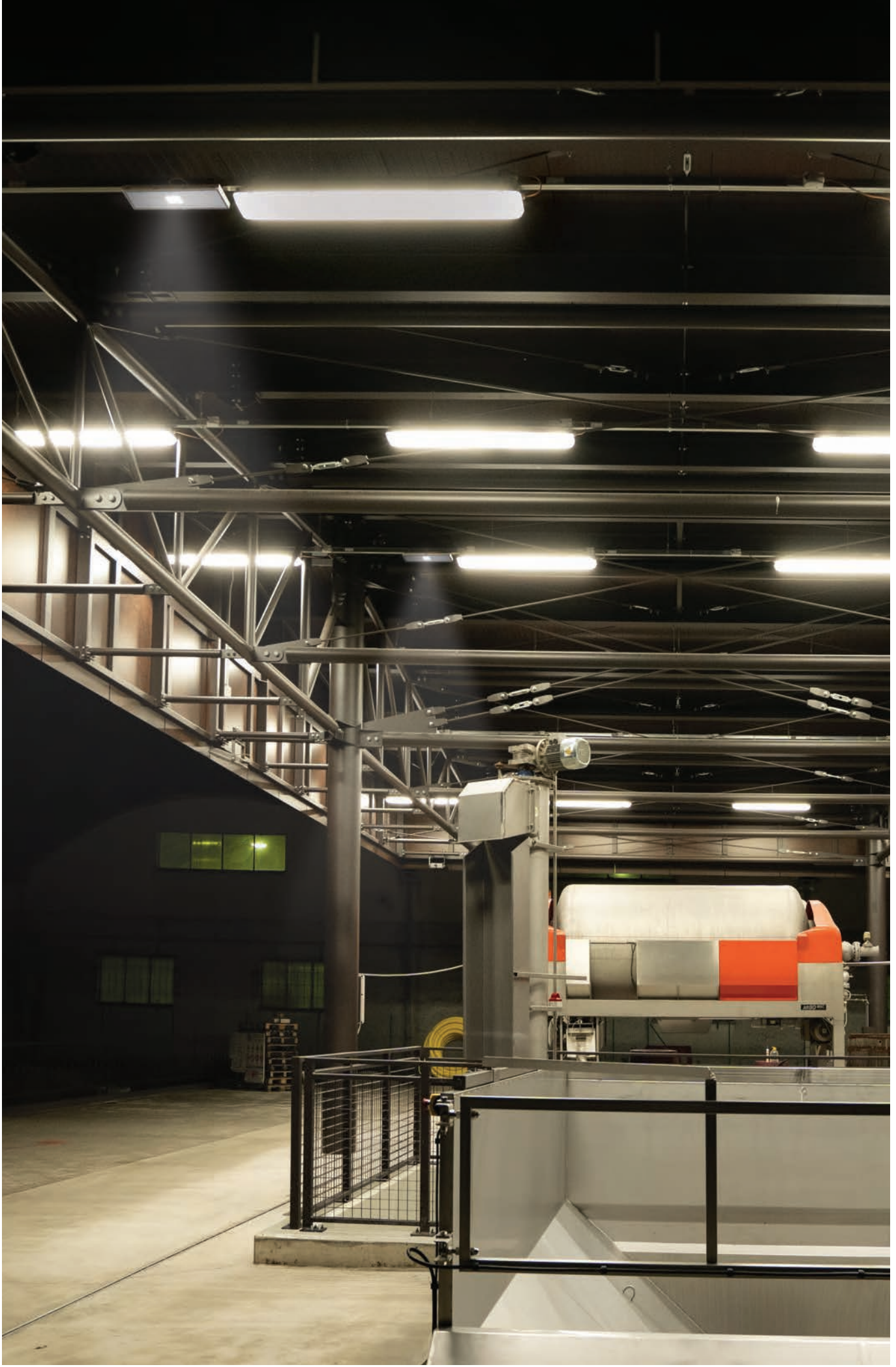

	<p><b>RECESSED BOX</b></p> <p>Order Code <b>4683</b></p>		<p><b>PROTECTIVE GRILLE</b> 440 x 215 x 99 mm</p> <p>Order Code <b>3912</b></p>
	<p><b>PLASTERBOARD RECESSED MOUNTING BRACKET</b></p> <p>Order Code <b>4687</b></p>		<p><b>SUSPENDED MOUNTING RODS</b> 250 - 500 - 1000 mm Order Code <b>4315</b> (250 mm) - <b>4316</b> (500 mm) - <b>4317</b> (1000 mm)</p>
	<p><b>45° BRACKET</b></p> <p>Order Code <b>4685</b></p>		<p><b>SUSPENDED MOUNTING HOOKS</b></p> <p>Order Code <b>3723</b></p>
	<p><b>5-POLE FEED-THROUGH WIRING</b> For all versions except LG</p> <p>Order Code <b>20155</b></p>		<p><b>LGFM MODULE</b> LG versions only</p> <p>Order Code <b>15037</b></p> <p><b>LGFM</b></p>
	<p><b>7-POLE FEED-THROUGH WIRING</b> LG versions only</p> <p>Order Code <b>20156</b></p>		<p><b>DALI MODULE</b> LG versions only</p> <p>Order Code <b>15038</b></p> <p><b>DALI</b></p>
	<p><b>LG INIBIT REMOTE CONTROL</b> RM for LG versions only</p> <p>Order Code <b>12101</b></p> <p><b>LG</b></p>		



# Formula 65

emergency



-  Adjustable autonomy and possibility of an additional battery to double the flux and safety (Autoripara battery).
-  Great flexibility thanks to multiple versions and accessories for all installation requirements.
-  Housing with numerous pre-drilled inlets and direct fixing on junction box.

## Applications

Industry, services

## Characteristics

**Power supply\*** 230VAC±10%, 50÷60Hz

**Mounting** Wall, ceiling, recessed, false ceiling

### Recharging time

12h with LTO and LiFe batteries

**Housing** Polycarbonate, white RAL 9003

**Optics** Symmetrical, white

**Screen** Clear polycarbonate

**Compliance** EN 60598-1, EN 60598-2-2, EN 60598-2-22, UNI EN 1838, UNI 11222, EN62034

\* LG230, LG24, HT systems consider the parameters of the control unit used

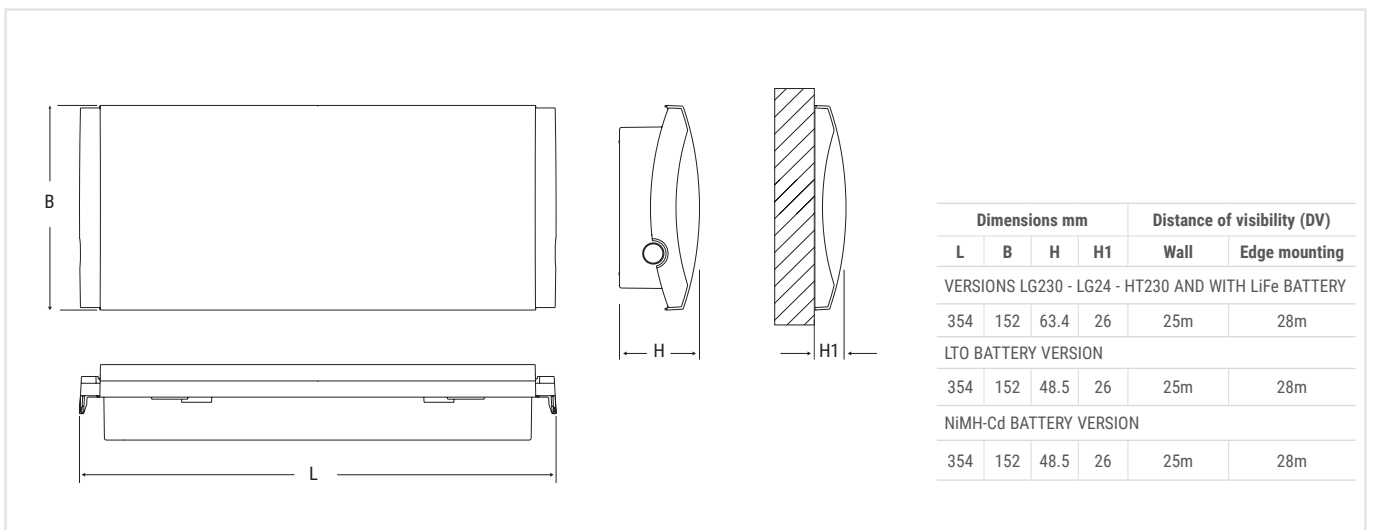

## Performance according to EN 1838

Height (m)	Centre distance (m) ESCAPE ROUTES		Illuminated surface area (m) LARGE AREAS	
	Wall	Ceiling	Wall	Ceiling
2.5	11	-	8x12	-
3	-	18	-	10x16
7	-	25	-	14x20

Lighting >1lx at floor level along the centre line without reflections Emax/Emin <40

Lighting >0.5lx at floor level without reflections Emax/Emin <40

Performance with reference to luminaire **Order Code 19430** 1100 lm

Maintenance coefficient 0.8

## FORMULA 65

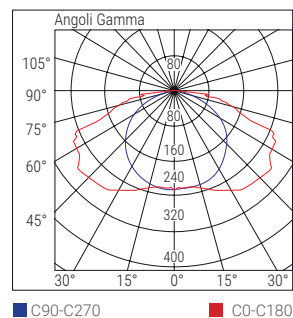

	Order Code	W eq.	Description	Version	Autonomy h	Battery	FLUX SE lm	AUTORIPARA Batt. OPTIONAL Flux SE lm	Input power		Weight Kg	Packaging Single/ Multi pack	Conform.
									DC	AC			
TR	19200N	6	F65 LED 6W IP65 SE 1/3 LIFE	SE	1/3	LiFe 3,2V 0,5Ah	150/70	-		1,1W	0,4	1/6	STANDARD
	19202N	8	F65 LED 8W IP65 SE 1/3 LIFE	SE	1/3	LiFe 3,2V 0,5Ah	200/80	-		1,1W	0,4	1/6	
	19204N	8	F65 LED 8W IP65 SA 1/3 LIFE	SA/SE	1/3	LiFe 3,2V 0,5Ah	200/80	-	160	2,5W	0,4	1/6	
	19206N	11	F65 LED 11W IP65 SE 1/3 LIFE	SE	1/3	LiFe 3,2V 1,5Ah	450/160	-		1,1W	0,6	1/6	
	19208N	11	F65 LED 11W IP65 SA 1/3 LIFE	SA/SE	1/3	LiFe 3,2V 1,5Ah	450/160	-	160	2,5W	0,6	1/6	
	19210N	24	F65 LED 24W IP65 SE 1/3 LIFE	SE	1/3	LiFe 3,2V 3Ah	700/240	-		1,1W	0,8	1/6	
	19212N	24	F65 LED 24W IP65 SA 1/3 LIFE	SA/SE	1/3	LiFe 3,2V 3Ah	700/240	-	160	2,5W	0,8	1/6	
	19430	36	F65 LED LI-FE SE	SE	1	LiFe 9.6V 1.5Ah	1500	-		1,1W	0,8	1/6	
19431	36	F65 LED LI-FE SA	SA/SE	1	LiFe 9.6V 1.5Ah	1500	-	300	3,8W	0,8	1/6		
AT	R0818	8	F65LED 8W IP65 AT AR SE123h RM	SE	1/2/3	NiCd 3.6V 0.75Ah	135/95/78	250/175/125		1.5W	0.4	1/12	AUTOTEST
	R1124	11	F65LED11W IP65 AT AR SE123h RM	SE	1/2/3	NiCd 3.6V 0.75Ah	180/125/90	315/220/160		1.5W	0.4	1/12	
	R1124SA	11	F65LED11W IP65 AT AR SA123h RM	SA/SE	1/2/3	NiCd 3.6V 0.75Ah	180/125/90	315/220/160	250	4.5W	0.6	1/12	
	R2436	24	F65LED24W IP65 AT AR SE123h RM	SE	1/2/3	NiMH 3.6V 1.2Ah	315/220/160	550/385/275		1.5W	0.6	1/12	
	R2436SA	24	F65LED24W IP65 AT AR SA123h RM	SA/SE	1/2/3	NiMH 3.6V 1.2Ah	315/220/160	550/385/275	280	5.0W	0.6	1/12	
	19432	36	F65 LED LI-FE AT AR SE	SE	1/1.5/3*	LiFe 9.6V 1.5Ah	1200/830/450	2200/1650/900		7W	0.8	1/6	
	19433	36	F65 LED LI-FE AT AR SA	SA/SE/PS	1/1.5/3*	LiFe 9.6V 1.5Ah	1200/830/450	2200/1650/900	1000	13W	0.8	1/6	
AT-OPT	19290	8	F65LED 8W IP65 AT OPT SE8LTO	SE	1/1.5/2/3/8	LTO 4.8V 1.2Ah	250/170/130/85/35	-		7.5W	0.5	1/6	CENTRALISED SELF-TESTING
	19291	11	F65LED 11W IP65 AT OPT SE8LTO	SE	1/1.5/2/3/8	LTO 4.8V 1.2Ah	315/210/160/110/45	-		7.5W	0.5	1/6	
	19292	24	F65LED 24W IP65 AT OPT SE8LTO	SE	1/1.5/2/3/8	2xLTO 4.8V 1.2Ah	550/370/280/190/80	-		7.5W	0.6	1/6	
	19293	24GL	F65LED 24GL IP65 AT OPT SE8LTO	SE	1/1.5/2/3/8	2xLTO 4.8V 1.2Ah	800/540/410/280/115	-		7.5W	0.6	1/6	
	19294	11	F65LED 11W IP65 AT OPT SA8LTO	SA/SE/PS	1/1.5/2/3/8	LTO 4.8V 1.2Ah	315/210/160/110/45	-	130	7.5W	0.5	1/6	
	19295	24	F65LED 24W IP65 AT OPT SA8LTO	SA/SE/PS	1/1.5/2/3/8	2xLTO 4.8V 1.2Ah	550/370/280/190/80	-	150	7.5W	0.6	1/6	
	19296	24GL	F65LED 24GL IP65 AT OPT SA8LTO	SA/SE/PS	1/1.5/2/3/8	2xLTO 4.8V 1.2Ah	800/540/410/280/115	-	200	7.5W	0.6	1/6	
LG	Standalone luminaires with Centralised Diagnostics integrating the Module Order No. 15036												
LGFM	Standalone luminaires with Centralised Radio Diagnostics integrating the Module Order Code 15037												
DALI	Standalone luminaires with Dali Centralised Diagnostics integrating the Module Order Code 15038												

\* The indicated autonomy doubles with the Autoripara battery, if the luminaire is set to LONG OPERATING TIME



# Formula 65

emergency

	Order Code	W eq.	Description	Version	Autonomy h	Battery	FLUX SE lm	Batt. AUTORIPARA OPTIONAL Flux SE lm	FLUX SA lm	Input power DC	AC	Weight Kg	Packaging Single/Multi pack		
LG	19434	36	F65 LED LI-FE LG AR SE	SE	1/1.5/3*	LiFe 9.6V 1.5Ah	1200/830/450	2200/1650/900				7W	0.8	1/6	CENTRALTEST
	19435	36	F65 LED LI-FE LG AR SA	SA/SE/PS	1/1.5/3*	LiFe 9.6V 1.5Ah	1200/830/450	2200/1650/900	1000		13W	0.8	1/6		
	<b>LGFM</b>	Standalone luminaires with Centralised Radio Diagnostics integrating the Module Order Code 15037													
	<b>DALI</b>	Standalone luminaires with Dali Centralised Diagnostics integrating the Module Order Code 15038													
LG230	31124	8	F65 LED 8W LG230						400	4.1W	8.5VA	0.6	1/6	CENTRALISED BATTERY	
	31125	11	F65 LED 11W LG230 LS-UV						600	6.4W	8.1VA	0.6	1/6		
	31150	24	F65 LED 24W LG230 LS-UV						1000	10.4W	12VA	0.6	1/6		
	31122	36	F65 LED 36W LG230 LS-UV						1600	15W	15.9VA	0.6	1/6		
LG24	32094	8	F65 LED 8W LGS24						400	3.8W		0.6	1/6	CENTRALISED BATTERY	
	32091	36	LED 36W LGS24 LS-UV						1600	4.3W	15.2VA	0.6	1/6		
HT230	17435	8	F65 LED 8W HT IP65						400	4.4W	8.9VA	0.6	1/6	CENTRALISED BATTERY	
	17436	11	F65 LED 11W HT IP65						600	6.1W	6.4VA	0.6	1/6		
	17437	24	F65 LED 24W HT IP65						1000	10.2W	10.4VA	0.6	1/6		
	17438	36	F65 LED 36W HT IP65						1600	14.3W	14.5VA	0.6	1/6		

\* The indicated autonomy doubles with the Autoripara battery, if the luminaire is set to LONG OPERATING TIME

## ACCESSORIES - included

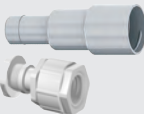

**CONDUIT ADAPTER 16/20 mm WHITE**  
Mounting with a Ø16 or Ø20 mm conduit

**CABLE CONDUIT GLAND M20**



**LH/RH/DOWN STICKERS**  
SA versions only

Order Code **19044**



**RECESSED BOX + FRAMES**  
For recessed mounting

Order Code **19040** (Versions with LTO, NiMh, NiCd battery)

## ACCESSORIES - to be ordered separately



**AR - AUTORIPARA BATTERY**  
Compatible with Order Code **R0818 - R1124 - R1124SA R2436 - R2436SA**  
Order Code **RA01** - NiMh 3.6V 1.2Ah



**EDGE MOUNTING WALL BRACKET**

Order Code **19045**



**AR - AUTORIPARA BATTERY**  
Compatible with Order Code **19432 - 19433 - 19434 19435**  
Order Code **RA06** - LIFE 9.6V 1.5Ah



**PROTECTIVE GRILLE**  
Dimensions 440x215x99 mm

Order Code **3912**



**RECESSED BOX + FRAMES**  
For recessed mounting

Order Code **19048** (Versions LG230, LG24, HT230 and LiFe battery)



**LG - LGFM - DALI MODULE**

**LG** - Order Code **15036** (with LTO battery only)  
**LGFM** - Order Code **15037** (with LiFe and LTO battery only)  
**DALI** - Order Code **15038** (with LiFe and LTO battery only)



**EX FALSE CEILING BRACKET**  
Recessed mounting hole: 370 x 130 mm

Order Code **19041** (Vers. with LTO, NiMh, NiCd battery)  
Order Code **19049** (Vers. LG230, LG24, HT230 and LiFe battery)



**LG INIBIT REMOTE CONTROL**  
RM only for LG versions and Codes 19432 - 19433

Order Code **12101**

**LG**



**EDGE MOUNTED SCREENS**  
Screen printing on clear polycarbonate

Order Code **19042** (LH/RH)  
Order Code **19043** (DOWN)



**RM INIBIT REMOTE CONTROL**  
RM only for Codes R0818 - R1124 - R1124SA R2436 - R2436SA

Order Code **2730**

**RM**



# Pratica IP65

emergency



IP65 luminaire particularly resistant to mechanical stress and weathering.



Innovative lens with RTI technology to increase mounting spacing and standardise pictogram illumination.



Housing equipped with many pre-drilled inlets, and accessories for  $\varnothing 16$  and  $\varnothing 20$ mm pipe inlets such as the PG16/20 adapter and the IP Plug membranes supplied.

## Applications

Industry, outdoors, services

## Characteristics

**Power supply** 230VAC  $\pm 10\%$ , 50÷60Hz

**Mounting** Recessed, wall, ceiling, edge mounting, suspended, electrified track

**Recharging time** 12h

**Housing** Polycarbonate, white RAL 9003

**Optics** PMMA lens with RTI technology (Total Internal Reflection)

**Housing** Polycarbonate, white RAL 9003

**Compliance** EN 60598-1, EN 60598-2-2, EN 60598-2-22, UNI EN 1838, UNI 11222, EN 62034.

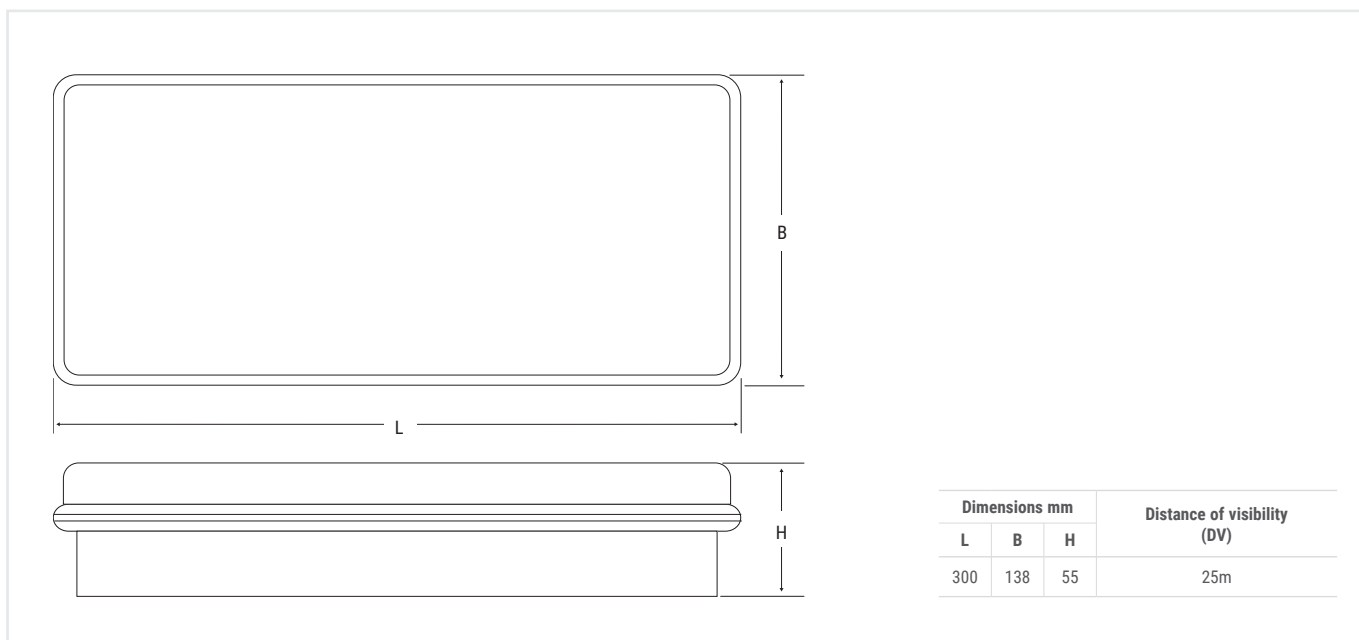

Dimensions mm			Distance of visibility (DV)
L	B	H	
300	138	55	25m

028



## Performance according to EN 1838

Height (m)	Centre distance (m) ESCAPE ROUTES		Illuminated surface area (m) LARGE AREAS	
	Wall	Ceiling	Wall	Ceiling
2.5	8	-	4x6	-
3	-	9	-	6x7

Lighting >1lx at floor level along the centre line without reflections Emax/Emin <40

Lighting >0.5lx at floor level without reflections Emax/Emin <40

Performance with reference to luminaire **Order Code 250SE** 250 lm Maintenance coefficient 0.8

## PRATICA IP65

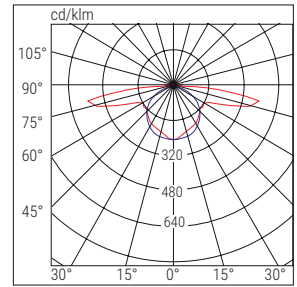

■ C90-C270

■ C0-C180

	Order Code	W eq.	Description	Version	Autonomy h	Battery	FLUX SE lm	FLUX SA lm	Input power		Weight Kg	Packaging Single/ Multi pack
									DC	AC		
TR	250SE	18	PRATICA 300LM 1.5/3h IP65 SETR	SE	1.5/3	LiFe 3.2V 1.5 Ah	300/160			1.2 W	1	1/12
	250SA	18	PRATICA 300LM 1.5/3h IP65 SATR	SA/SE	1.5/3	LiFe 3.2V 1.5 Ah	300/160	200		2.5 W	0.8	1/12
	500SE	24	PRATICA 500LM 1.5/3h IP65 SETR	SE	1.5/3	LiFe 3.2V 3Ah	500/250			1.2 W	1.1	1/12
	500SA	24	PRATICA 500LM 1.5/3h IP65 SATR	SA/SE	1.5/3	LiFe 3.2V 3Ah	500/250	200		2.5 W	0.9	1/12
AT	250ATSE	18	PRATICA 300LM 1.5/3h IP65 SEAT	SE	1.5/3	LiFe 3.2V 1.5 Ah	300/160			2.6 W	1	1/12
	250ATSA	18	PRATICA 300LM 1.5/3h IP65 SAAT	SA/SE	1.5/3	LiFe 3.2V 1.5 Ah	300/160	200		4.8 W	0.8	1/12
	500ATSE	24	PRATICA 500LM 1.5/3h IP65 SEAT	SE	1.5/3	LiFe 3.2V 3 Ah	500/250			2.6 W	1.1	1/12
	500ATSA	24	PRATICA 500LM 1.5/3h IP65 SAAT	SA/SE	1.5/3	LiFe 3.2V 3 Ah	500/250	200		4.8 W	0.9	1/12

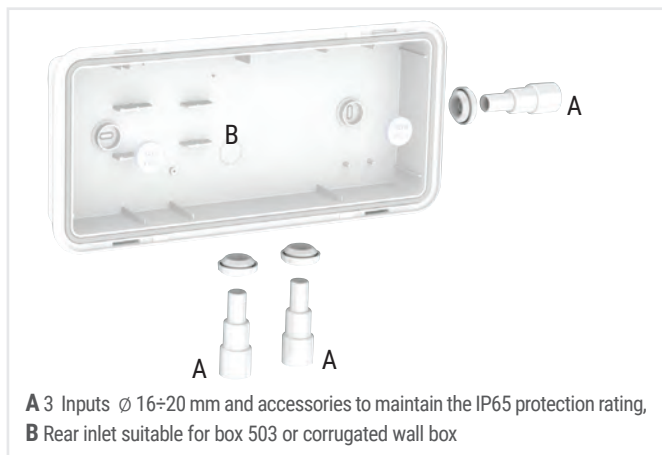

## ACCESSORIES - included

	<b>CONDUIT ADAPTER 16/20 mm WHITE</b> <b>2 CABLE GLAND MEMBRANES IP65</b> Mounting with a $\varnothing 16$ or $\varnothing 20$ mm conduit
	<b>LH/RH/DOWN/UP STICKERS</b> SA versions only  Order Code <b>4117</b>

## ACCESSORIES - to be ordered separately

	<b>SUSPENDED MOUNTING HOOKS</b>  Order Code <b>3723</b>
	<b>RECESSED BOX</b>  Order Code <b>2742</b>
	<b>PROTECTIVE GRILLE</b> Dimensions 440x215x99 mm  Order Code <b>3912</b>
	<b>RM MODULE</b> RM  Order Code <b>15048</b>
	<b>FALSE CEILING BRACKET</b>  Order Code <b>2751</b>
	<b>SCREENS</b> Order Code <b>4124</b> (LH/RH) Order Code <b>4125</b> (DOWN) Order Code <b>4126</b> (UP)
	<b>RM INHIBIT REMOTE CONTROL</b> For RM versions  Order Code <b>2730</b>
	<b>LH/RH/DOWN/UP STICKERS</b>  Order Code <b>4117</b>

# Pratica IP42

emergency



IP42
IK07
850°
□
Batt. LiFe
+40°C  
0°C



Luminaire suitable for both emergency lighting and signage, thanks to the pictograms provided. Housing built to withstand outdoor use, equipped with LiFe battery and a 5-year warranty.



Unique luminaire with SE and SA function, with adjustable autonomy from 1 to 3hrs.



Large spaces inside the product facilitate wiring and maintenance. The housing is equipped with 3 x ø16 pre-drilled inlets and can be installed over a 503 box. Recessed box supplied.

## Applications

Services, commercial activities, shops, restaurants, offices

## Characteristics

**Power supply** 230VAC ± 10%, 50÷60Hz

**Mounting** Wall, ceiling, recessed, suspended, electrified track

**Recharging time** 12h with LiFe battery

**Housing** Polycarbonate, white RAL 9003

**Screen** Clear polycarbonate

**Compliance** EN 60598-1, EN 60598-2-2, EN 60598-2-22, UNI EN 1838, UNI 11222, EN 62034

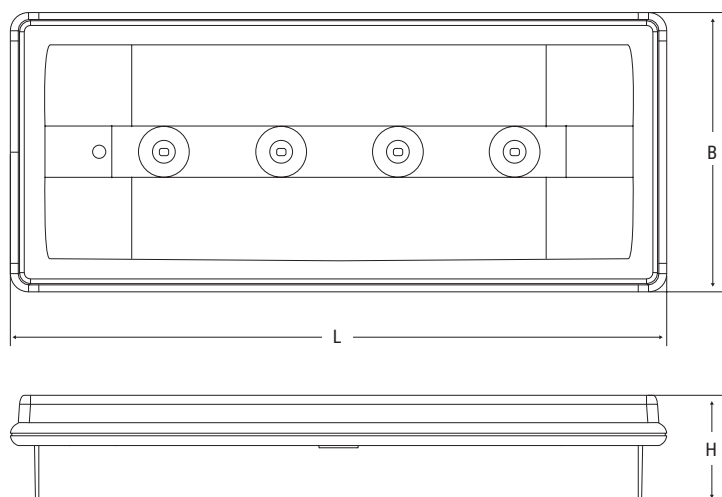

Dimensions mm			Distance of visibility (DV)
L	B	H	
280	119	46	21m

## Performance according to EN 1838

Height (m)	Centre distance (m) ESCAPE ROUTES		Illuminated surface area (m) LARGE AREAS	
	Wall	Ceiling	Wall	Ceiling
2.5	5	-	3x3	-
3	-	8	-	6x6
Lighting >1lx at floor level along the centre line without reflections Emax/Emin <40			Lighting >0.5lx at floor level without reflections Emax/Emin <40	
Performance with reference to luminaire <b>Order Code 4400</b> 100 lm			Maintenance coefficient 0.8	

## PRATICA IP42

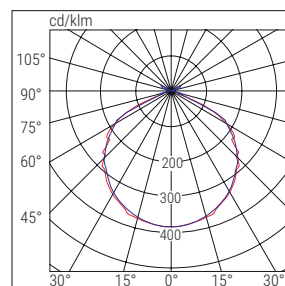

■ C0-C180 ■ C90-C270

	Order Code	W eq.	Description	Version	Autonomy h	Battery	FLUX SE lm	FLUX SA lm	Input power		Weight Kg	Packaging Single/Multi pack
									DC	AC		
TR	4400	11	PRATICA 200LM 1/1.5/3h IP42 SATR	SA/SE	1/1.5/3	LiFe 3.2V 0.5Ah	200/160/100	100	1.4 W	0.25	1/12	STANDARD
	4401	18	PRATICA 300LM 1.5/3h IP42 SATR	SA/SE	1.5/3	LiFe 3.2V 1.5Ah	300/160	200	2.5 W	0.3	1/12	
	4402	24	PRATICA 500LM 1.5/3h IP42 SATR	SA/SE	1.5/3	LiFe 3.2V 3Ah	500/250	200	2.5 W	0.35	1/12	
AT	4403	11	PRATICA 200LM 1/1.5/3h IP42 SAAT	SA/SE	1/1.5/3	LiFe 3.2V 0.5Ah	200/160/100	100	1.4 W	0.25	1/12	AUTOTEST
	4404	18	PRATICA 300LM 1.5/3h IP42 SAAT	SA/SE	1.5/3	LiFe 3.2V 1.5Ah	300/160	200	4.8 W	0.3	1/12	
	4405	24	PRATICA 500LM 1.5/3h IP42 SAAT	SA/SE	1.5/3	LiFe 3.2V 3Ah	500/250	200	4.8 W	0.35	1/12	

## ACCESSORIES - included

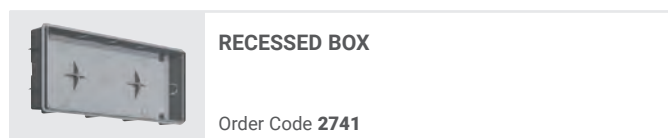
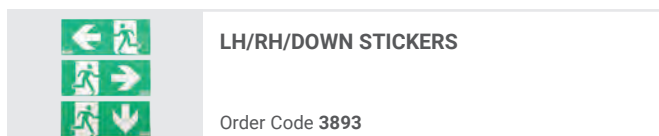

## ACCESSORIES - to be ordered separately

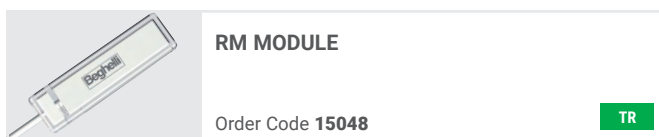
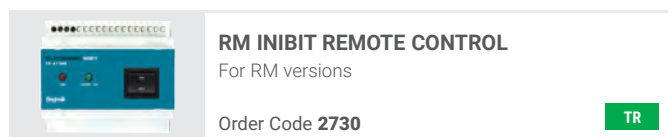
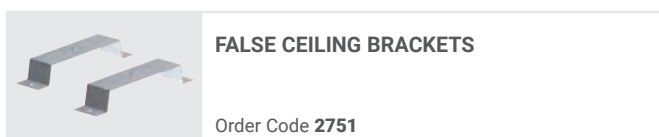
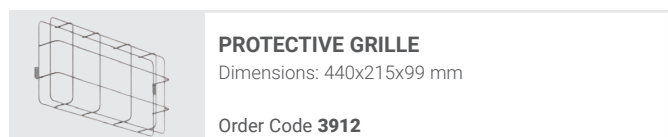
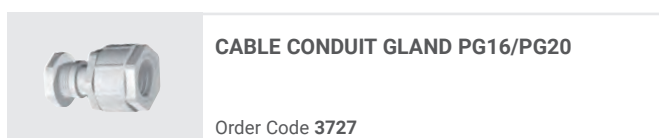
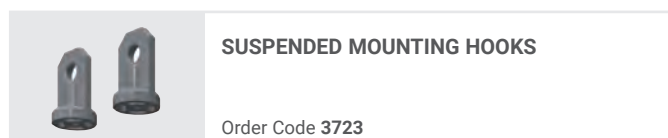

# Ticinque

emergency



IP65

IP42

IK07

850°



Batt. LiFe

+40°C  
0°C



High autonomy luminaire, up to 8hrs. In the Granluce version, the flux is up to 1,250 lm, with a set autonomy of 1h. Also suitable for special applications where high luminous fluxes are required (10lx with an autonomy of 90 min).



Available in both IP42 and IP65 protection ratings; with pictograms installed, the distance of visibility is 28m.



Easy installation thanks to the PG16/20 quick connector and the supplied IP Plug membranes. Quick connection on all 4 sides while maintaining the IP65 protection rating, even on an electrified track.

## Applications

Industry, services, shopping centres

## Characteristics

**Power supply** 230VAC  $\pm$  10%, 50÷60Hz

**Mounting** Wall, ceiling

**Recharging time** 12h

**Housing** Polycarbonate, white RAL 9003

**Optics** Symmetrical, white

**Screen** Clear polycarbonate

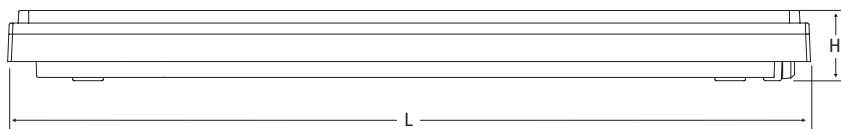
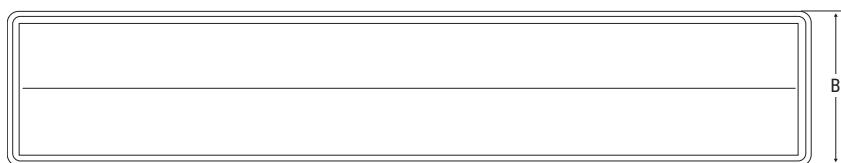

**Compliance** EN 60598-1, EN 60598-2-22, UNI EN 1838, UNI 11222, EN 62034



Dimensions mm			Distance of visibility (DV)
L	B	H	
549	147	43	28m

032

## Performance according to EN 1838

Height (m) 	Centre distance (m) ESCAPE ROUTES 		Illuminated surface area (m) LARGE AREAS 	
	Wall	Ceiling	Wall	Ceiling
2.5	8	-	8x8	-
3	-	16	-	11x11
7	-	22	-	14x14
Lighting >1lx at floor level along the centre line without reflections Emax/Emin <40			Lighting >0.5lx at floor level without reflections Emax/Emin <40	
Performance with reference to luminaire <b>Order Code 8590</b> 800 lm			Maintenance coefficient 0.8	

## TICINQUE

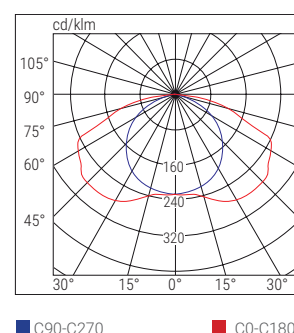

■ C90-C270

■ C0-C180

	Order Code	W eq.	Description	Version	Autonomy h	Battery	FLUX SE lm	FLUX SA lm	Input power		Weight Kg	Packaging Single/ Multi pack	Notes
									DC	AC			
TR	8584	18	TICINQUE IP42 LED 18WSE8P	SE	8	LiFe 9.6V 1.5 Ah	260			2W	1.8	1/6	IP42
	8585	18	TICINQUE IP42 LED 18WSA8P	SA/SE	8	LiFe 9.6V 1.5 Ah	260	180		4W	1.8	1/6	IP42
	8586	18	TICINQUE IP65 LED 18WSE8P	SE	8	LiFe 9.6V 1.5 Ah	260			2W	1.8	1/6	IP65
	8587	18	TICINQUE IP65 LED 18WSA8P	SA/SE	8	LiFe 9.6V 1.5 Ah	260	180		4W	1.8	1/6	IP65
	8590	24	GRANLUCE T5LED IP65 SE2h	SE	2	LiFe 9.6V 1.5 Ah	800			5W	2	1/6	IP65
	8591	24	GRANLUCE T5LED IP65 SA2h	SA/SE	2	LiFe 9.6V 1.5 Ah	800	180		8W	2	1/6	IP65
	8597	24	GRANLUCE T5LED IP65 SE1h	SE	1	LiFe 9.6V 1.5 Ah	1500			5W	2	1/6	IP65
	8598	24	GRANLUCE T5LED IP65 SA1h	SA/SE	1	LiFe 9.6V 1.5 Ah	1500	180		8W	2	1/6	IP65
AT	8592	24	GRANLUCE T5LED AT IP65 SE123h	SE	1/2/3	LiFe 9.6V 1.5 Ah	1250/800/550			5W	2	1/6	IP65
	8593	24	GRANLUCE T5LED AT IP65 SA123h	SA/SE	1/2/3	LiFe 9.6V 1.5 Ah	1250/800/550	400		15W	2	1/6	IP65

## ACCESSORIES - included

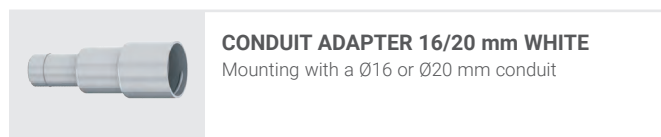
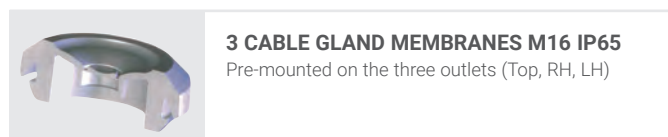

## ACCESSORIES - to be ordered separately

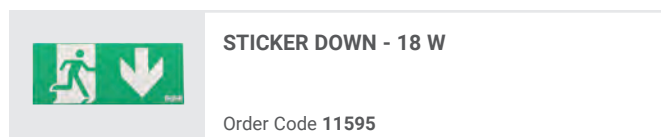
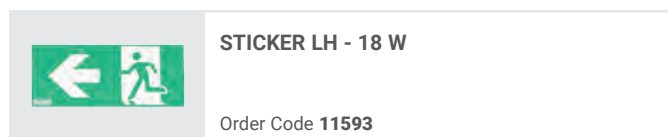
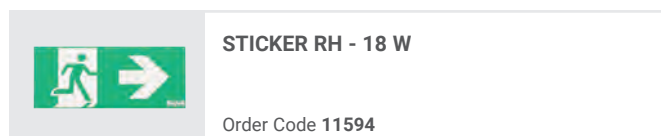
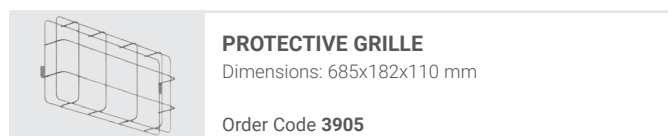



# Ticinque TuttoLED

emergency



IP65

IP42

IK07

850°



Batt. LiFe

+40°C  
0°C



Autonomy up to 5hrs, luminous flux up to 400lm.



Available in both IP42 and IP65 protection ratings; with pictograms installed, the distance of visibility is 28m.



Equipped with PG16/20 quick connector and IP Plug membranes for quick connections on all 4 sides.

## Applications

Industry, services

## Characteristics

**Power supply** 230VAC  $\pm$  10%, 50÷60Hz

**Mounting** Wall, ceiling

**Recharging time** 12h

**Housing** Polycarbonate, grey RAL 7035

**Optics** Symmetrical, white

**Screen** Clear polycarbonate

**Compliance** EN 60598-1, EN 60598-2-22, UNI EN 1838, UNI 11222, EN 62034

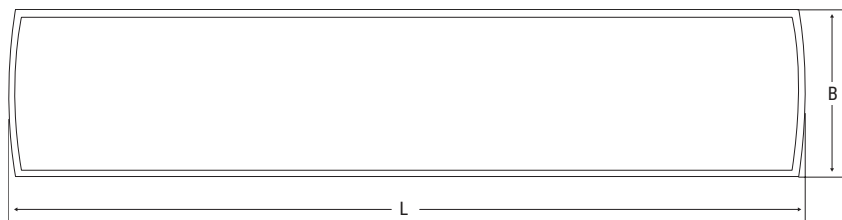

Dimensions mm			Distance of visibility (DV)
L	B	H	
610	128	54	28m

034

## Performance according to EN 1838

Height (m)	Centre distance (m) ESCAPE ROUTES		Illuminated surface area (m) LARGE AREAS	
	Wall	Ceiling	Wall	Ceiling
2.5	7	-	6x6	-
3	-	12	-	9x9
Lighting >1lx at floor level along the centre line without reflections Emax/Emin <40			Lighting >0.5lx at floor level without reflections Emax/Emin <40	
Performance with reference to luminaire <b>Order Code 8595</b> 400 lm			Maintenance coefficient 0.8	

## TICINQUE TUTTOLED

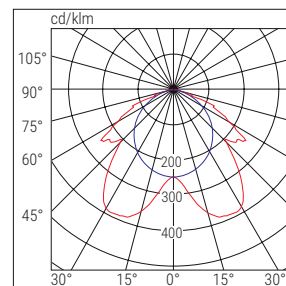

■ C90-C270

■ C0-C180

	Order Code	W eq.	Description	Version	Autonomy h	Battery	FLUX SE lm	FLUX SA lm	Input power		Weight Kg	Packaging Single/Multi pack	Notes
									DC	AC			
TR	8594	18	TICINQUETUTTOLED IP42 18SE5P	SE	5	LiFe 9.6V 1.5Ah	400	-	5W	1.8	1/6	IP42	STANDARD
	8596	18	TICINQUETUTTOLED IP65 18SA5P	SA/SE	5	LiFe 9.6V 1.5Ah	400	220	8W	2.0	1/6	IP65	
	8595	18	TICINQUETUTTOLED IP65 18SE5P	SE	5	LiFe 9.6V 1.5Ah	400	-	5W	2.0	1/6	IP65	

## ACCESSORIES - included

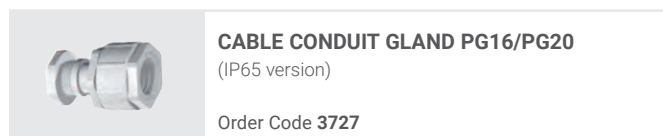
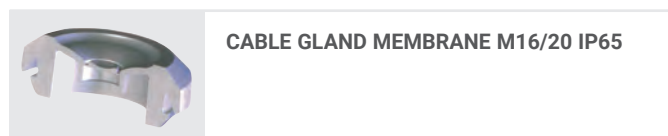

## ACCESSORIES - to be ordered separately

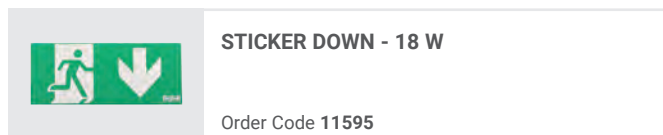
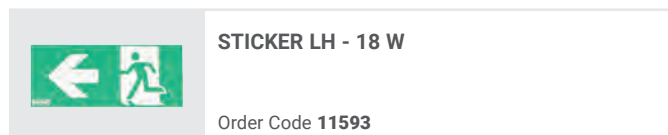
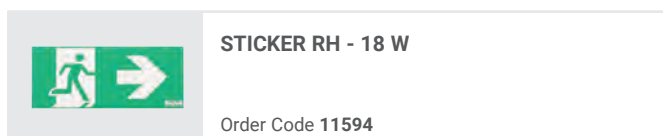
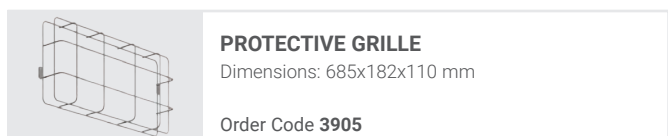



# UP LED

emergency



 Compact design with only 2 cm thickness. Luminous flux up to 450 lm. Version with a fast-charging Titanium Battery (LTO), with 10 years of service life and for extreme working temperatures.

 Adjustable autonomy from 1.5 to 8hrs. All accessories are available for special mounting, such as the three-phase track kit.

 Optical system with 4 transparent lenses to maximise illumination. The 824 version installs opal lenses for a more diffuse illumination.

## Applications

Industry, services, hospitals, schools, residential

## Characteristics

### Power supply

**UP LED:** 230Vac ± 10%, 50÷60Hz

**UP LED 824:** 230Vac ± 10%, 50÷60Hz, 120Vac ± 10%, 50÷60Hz

**Mounting** Wall, ceiling, three-phase track

**Recharging time** 12hrs with LTO battery

**Housing** Polycarbonate, white RAL 9003

**Optics** Clear polycarbonate lenses

**Screen** Clear polycarbonate

**Compliance** EN 60598-1, EN 60598-2-22, UNI EN 1838, UNI 11222, EN 62034

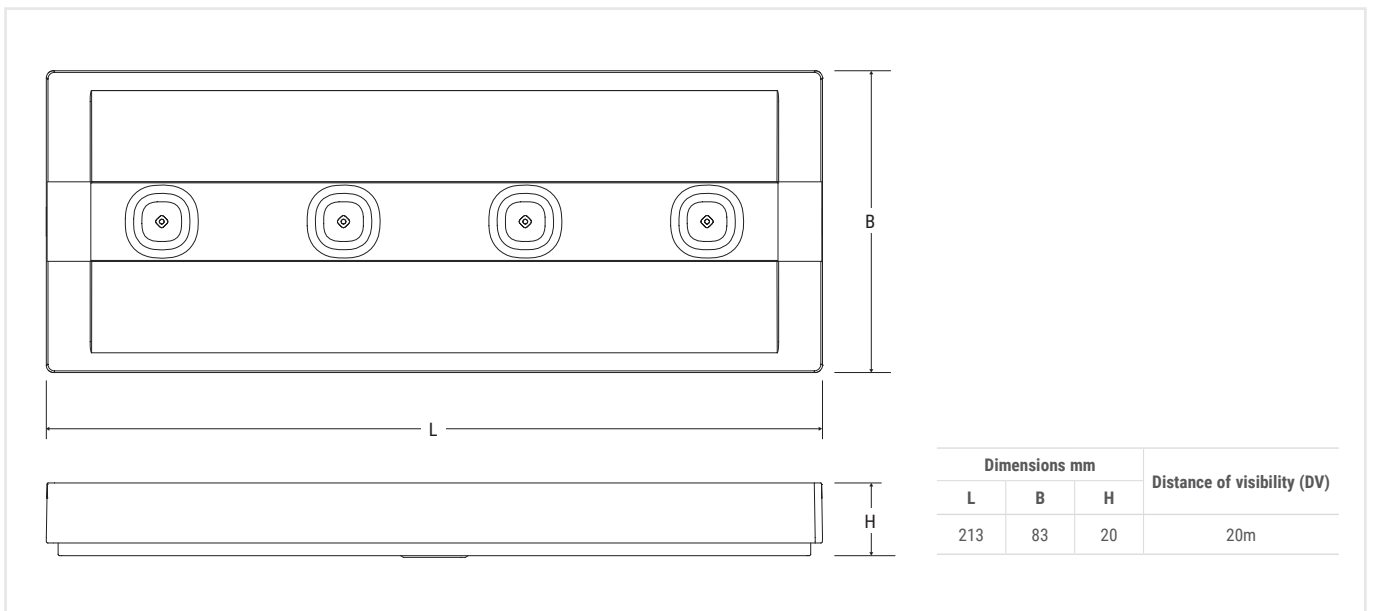

Dimensions mm			Distance of visibility (DV)
L	B	H	
213	83	20	20m

## Performance according to EN 1838

Height (m)	Centre distance (m) ESCAPE ROUTES		Illuminated surface area (m) LARGE AREAS	
	Wall	Ceiling	Wall	Ceiling
2.5	8	-	5x6	-
3	-	15	-	14x14
Lighting >1lx at floor level along the centre line without reflections Emax/Emin <40			Lighting >0.5lx at floor level without reflections Emax/Emin <40	
Performance with reference to luminaire Order Code 4304 450 lm			Maintenance coefficient 0.8	

## UP LED

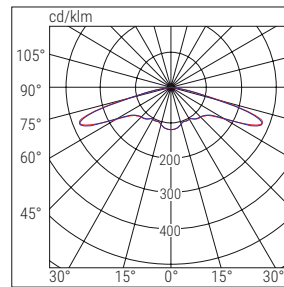

■ C90-C270

## UP LED 824

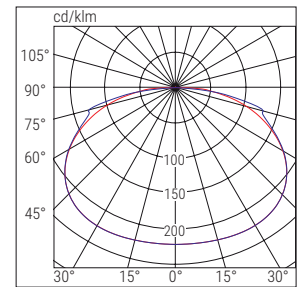

■ C0-C180

■ C0-C180

■ C90-C270

	Order Code	W eq.	Description	Version	Autonomy h	Battery	FLUX SE lm	FLUX SA lm	Input power		Weight Kg	Packaging Single/Multi pack
									DC	AC		
TR	4300	6-8	UP LED 6-8W SE 1/2/3N IP65 RM	SE	1/2/3	NiCd 3.6V 0.75 Ah	240/140/95	-	0.8W	0.25	12	STANDARD
	4301	11-24	UP LED 11-24W SE 1/2/3h IP65 RM	SE	1/2/3	NiMh 3.6V 1.2 Ah	340/195/130	-	0.8W	0.25	12	
	4302	24-36	UP LED 24-36W SE 1/2/3h IP65 RM	SE	1/2/3	NiMh 3.6V 1.5 Ah	450/240/170	-	1.2W	0.27	12	
	4303	11-24	UP LED 11-24W SA 1/2/3h IP65 RM	SA/SE	1/2/3	NiMh 3.6V 1.2 Ah	340/195/130	180	3.0W	0.25	12	
	4304	24-36	UP LED 24-36W SA 1/2/3h IP65 RM	SA/SE	1/2/3	NiMh 3.6V 1.5 Ah	450/240/170	240	3.5W	0.27	12	
	824S	24	UP LED 824S SE 100L 120° RM	SE	2	NiCd 3.6V 0.75Ah	100	-	0.8W	0.25	1/12	
	824M	24	UP LED 824M SE 150L 90° RM	SE	1.5	NiCd 3.6V 0.75Ah	150	-	0.8W	0.25	1/12	
	824L	24	UP LED 824L SE 250L 90° RM	SE	1.5	NiMH 3.6V 1.2A	250	-	0.8W	0.25	1/12	
	824MSA	24	UP LED 824M SA 150L 90° RM	SA/SE	1.5	NiCd 3.6V 0.75Ah	150	100	2.0W	0.25	1/12	
824LSA	24	UP LED 824L SA 250L 90° RM	SA/SE	1.5	NiMH 3.6V 1.2A	250	100	2.0W	0.25	1/12		
AT - OPT	4370	11-24	UPLD 1124W IP65 AT OPT SE8LTO	SE	1/1.5/2/3/8	LTO 4.8V 0.5Ah	250/170/130/85/35	-	7.5W	0.3	1/12	CENTRALISED SELF-TESTING
	4371	24-36	UPLD 2436W IP65 AT OPT SE8LTO	SE	1/1.5/2/3/8	LTO 4.8V 1Ah	450/305/230/155/65	-	7.5W	0.3	1/12	
	4372	11-24	UPLD 1124W IP65 AT OPT SA8LTO	SA/SE	1/1.5/2/3/8	LTO 4.8V 0.5Ah	250/170/130/85/35	110	7.5W	0.3	1/12	
	4373	24-36	UPLD 2436W IP65 AT OPT SA8LTO	SA/SE	1/1.5/2/3/8	LTO 4.8V 1Ah	450/305/230/155/65	200	7.5W	0.3	1/12	
	LG	Standalone luminaires with Centralised Diagnostics integrating the Module Order No. 15036										
	LGFM	Standalone luminaires with Centralised Radio Diagnostics integrating the Module Order Code 15037										
	DALI	Standalone luminaires with Dali Centralised Diagnostics integrating the Module Order Code 15038										

## ACCESSORIES - to be ordered separately



**LH/RH/DOWN/UP SCREENS**  
Label on opal polycarbonate

Order Code **4326**



**IP65 ACCESSORY KIT**  
Cable gland, 2 plugs, perimeter seal  
Only required for IP65 rating in 824 versions

Order Code **4318**



**EDGE MOUNTED SCREEN**

Order Code **4325**

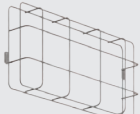

**PROTECTIVE GRILLE**  
Dimensions: 305x110x100 mm

Order Code **3903**



**LG - LGFM - DALI MODULE** (AT-OPT version only)

**LG** - Order Code **15036**

**LGFM** - Order Code **15037**

**DALI** - Order Code **15038**

LG
LGFM
DALI



**THREE-PHASE TRACK KIT**

Order Code **4319**



**RM INHIBIT REMOTE CONTROL**  
For TR versions

Order Code **2730**

RM

## ACCESSORIES - included



**IP65 ACCESSORY KIT**  
Cable gland, 2 plugs, perimeter seal  
Excluding version 824

Order Code **4318**

# Completa

emergency



With enclosure    With enclosure

IP40    IK07    IP66    IK09    850°

Batt. LTO    Batt. NiMH    Batt. NiCd

+45°C / -20°C    +40°C / 0°C    +40°C / 0°C



Adjustable autonomy from 1 to 8 hrs. Version with a fast-charging Titanium Battery (LTO) for extreme working temperatures. **IK09** rating with optional IP66 enclosure, with **a mechanical resistance up to 5 times greater than that of a standard luminaire.**



The extensive range of accessories allows one luminaire to be used for recessed, ceiling, edge mounting and plasterboard applications. IP66 IK09 enclosure for harsh environments.



Recessed mounting with separated body of the diffuser/reflector unit, which remains integrated with the electronics and can be quickly installed in the recessed box provided.

## Applications

Industry, services

## Characteristics

### Power supply

230Vac ± 10%, 50÷60Hz

**Mounting:** Wall, ceiling, recessed, false ceiling, edge mounting and wall signage

**Recharging time** 12hrs with LTO battery

**Housing** Polycarbonate, white RAL 9003

**Optics** Symmetrical, white

**Screen** Clear polycarbonate

**Compliance** EN 60598-1, EN 60598-2-2, EN 60598-2-22, UNI EN 1838, UNI 11222, EN 62034

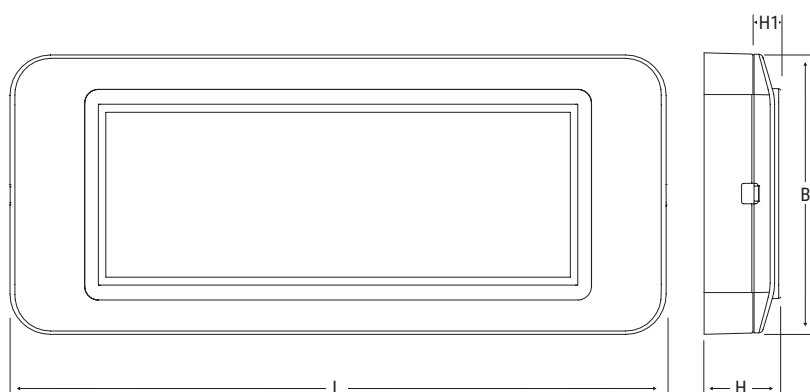

Dimensions mm				Distance of visibility (DV)	
L	B	H	H1	Wall	Edge mounting
CEILING					
294	126	34	-	15m	20m
RECESSED					
292	124	35	12	15m	20m
IP65 ENCLOSURE					
317	149	46	-	15m	20m



## Performance according to EN 1838

Height (m)	Centre distance (m) ESCAPE ROUTES		Illuminated surface area (m) LARGE AREAS	
	Wall	Ceiling	Wall	Ceiling
2.5	6	-	4x6	-
3	-	11	-	8x8
Lighting >1lx at floor level along the centre line without reflections Emax/Emin <40			Lighting >0.5lx at floor level without reflections Emax/Emin <40	
Performance with reference to luminaire <b>Order Code 4108</b> 225 lm			Maintenance coefficient 0.8	

## COMPLETA

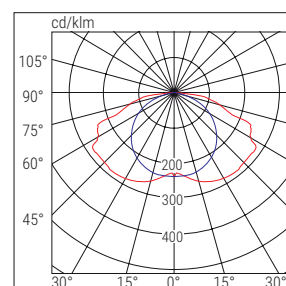

■ C90-C270

■ C0-C180

	Order Code	W eq.	Description	Version	Autonomy h	Battery	FLUX SE lm	FLUX SA lm	Input power		Weight Kg	Packaging Single/Multi pack	Conform.
									DC	AC			
TR	4101N	6	COMPLETA LED 6W SE 1/3 LIFE	SE	1/3	LiFe 3,2V 0,5Ah	150/70	-	1.1W	0.5	1/6	STANDARD	
	4102N	8	COMPLETA LED 8W SE 1/3 LIFE	SE	1/3	LiFe 3,2V 0,5Ah	200/80	-	1.1W	0.5	1/6	STANDARD	
	4103N	11	COMPLETA LED 11W SE 1/3 LIFE	SE	1/3	LiFe 3,2V 1,5Ah	500/180	-	1.1W	0.6	1/6	STANDARD	
	4105N	11	COMPLETA LED 11W SA 1/3 LIFE	SA/SE	1/3	LiFe 3,2V 1,5Ah	500/180	160	2,5W	0.6	1/6	STANDARD	
	4108N	24	COMPLETA LED 24W SE 1/3 LIFE	SE	1/3	LiFe 3,2V 1,5Ah	700/240	-	1.1W	0.6	1/6	STANDARD	
	4110N	24	COMPLETA LED 24W SA 1/3 LIFE	SA/SE	1/3	LiFe 3,2V 1,5Ah	700/240	160	2,5W	0.6	1/6	STANDARD	
AT - OPT	4200	8-11	CPLED 811W IP40 AT OPT SE 8LT	SE	1/1.5/2/3/8	LTO 4.8V 0.5Ah	150/100/75/55/25	-	7.5W	0.5	1/6	CENTRALISED SELF-TESTING	
	4201	11-24	CPLED 1124W IP40 AT OPT SE 8LT	SE	1/1.5/2/3/8	LTO 4.8V 0.5Ah	250/170/130/85/35	-	7.5W	0.5	1/6	CENTRALISED SELF-TESTING	
	4202	24-36	CPLED 2436W IP40 AT OPT SE 8LT	SE	1/1.5/2/3/8	2xLTO 4.8V 0.5Ah	450/305/230/156/65	-	7.5W	0.5	1/6	CENTRALISED SELF-TESTING	
	4203	11-24	CPLED 1124W IP40 AT OPT SA 8LT	SA/SE	1/1.5/2/3/8	LTO 4.8V 0.5Ah	250/170/130/85/35	110	7.5W	0.5	1/6	CENTRALISED SELF-TESTING	
	4204	24-36	CPLED 2436W IP40 AT OPT SA 8LT	SA/SE	1/1.5/2/3/8	2xLTO 4.8V 0.5Ah	450/305/230/156/65	200	7.5W	0.5	1/6	CENTRALISED SELF-TESTING	
	LG	Standalone luminaires with Centralised Diagnostics integrating the Module Order No. 15036											
	LGFM	Standalone luminaires with Centralised Radio Diagnostics integrating the Module Order Code 15037											
	DALI	Standalone luminaires with Dali Centralised Diagnostics integrating the Module Order Code 15038											

# Completa

emergency

## ACCESSORIES - included



**LH/RH/DOWN STICKERS**

Order Code **4278**



**RECESSED BOX**

Order Code **3733**

## ACCESSORIES - to be ordered separately



**IP66 - IK09 ENCLOSURE KIT**

To achieve a mechanical resistance up to 5 times greater than that of standard luminaires (IK07)

Order Code **4112**



**DOWN EDGE MOUNTED SCREEN**

Screen printing on clear polycarbonate

Order Code **4268**

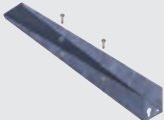

**WALL BRACKET X EDGE MOUNTING**

Order Code **4265**



**LH/RH EDGE MOUNTED SCREENS**

Screen printing on clear polycarbonate

Order Code **4267**



**FALSE CEILING BRACKET**

Order Code **4266**



**LH/RH/DOWN SCREENS**

Screen printing on opal polycarbonate

Order Code **4269**



**LG - LGFM - DALI MODULE (AT-OPT version only)**

**LG** - Order Code **15036**

**LGFM** - Order Code **15037**

**DALI** - Order Code **15038**

**LG** **LGFM** **DALI**

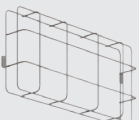

**PROTECTIVE GRILLE**

Dimensions: 440x215x98,7 mm

Order Code **3912**



# Stile In

emergency



Luminaire designed for recessed mounting, with an autonomy of up to more than 8 hrs.



The extensive range of accessories allows one luminaire to be used for recessed, edge mounting and plasterboard applications.



For recessed mounting, a box is provided; for ceiling mounting, the housing is pre-fitted with several pre-drilled inlets to allow the entry of wire ways from all directions.

## Applications

Services, commercial activities, shops, restaurants, offices

## Characteristics

**Power supply** 230VAC  $\pm$  10%, 50÷60Hz

**Mounting** Wall, ceiling, recessed, false ceiling, edge mounting

**Recharging time** 12h with LiFe battery

**Housing** Polycarbonate, white RAL 9003

**Optics** symmetrical, polycarbonate, white

**Screen** Clear polycarbonate

**Compliance** EN 60598-1, EN 60598-2-2, EN 60598-2-22, UNI EN 1838, UNI 11222, EN 62034

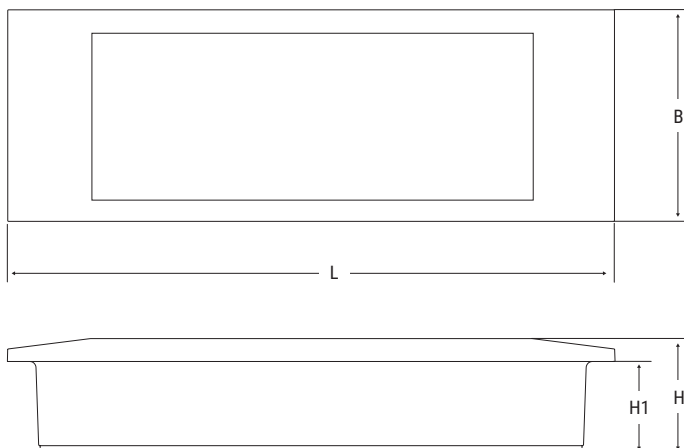

Dimensions mm				Distance of visibility (DV)	
L	B	H	H1	screen	edge mounting
292	102	55.5	44.5	15m	20m

## Performance according to EN 1838

Height (m)	Centre distance (m) ESCAPE ROUTES		Illuminated surface area (m) LARGE AREAS	
	Wall	Ceiling	Wall	Ceiling
2.5	5	-	3x3	-
3	-	7	-	5x5
Lighting >1lx at floor level along the centre line without reflections Emax/Emin <40			Lighting >0.5lx at floor level without reflections Emax/Emin <40	
Performance with reference to luminaire Order Code 1499L 130 lm			Maintenance coefficient 0.8	

### STILE IN 1499, 1499-24

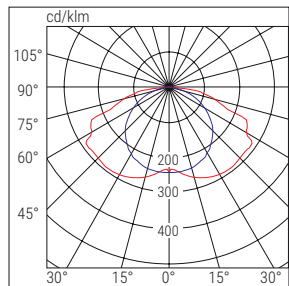

■ C90-C270 ■ C0-C180

### STILE IN 1499L

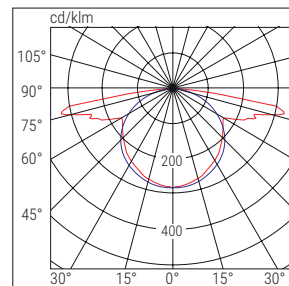

■ C90-C270 ■ C0-C180

	Order Code	W eq.	Description	Version	Autonomy h	Battery	FLUX SE lm	FLUX SA lm	Input power		Weight Kg	Packaging Single/Multi pack	Conform.
									DC	AC			
TR	1499	8	STILE IN LED 11 SE 8P	SE	8	Pb 4V 3Ah	130	-	2W		0.7	12	STANDARD
	1499/24	8	STILE IN LED 24 SE 6P	SE	6	Pb 4V 3Ah	200	-	2W		0.8	12	
	1499L	11	STILE IN LED 11 SE8 LI-FE	SE	8	LiFe 3.2V 3Ah	130	-	2W		0.4	12	

## ACCESSORIES - included

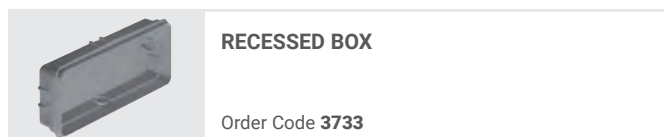

## ACCESSORIES - to be ordered separately

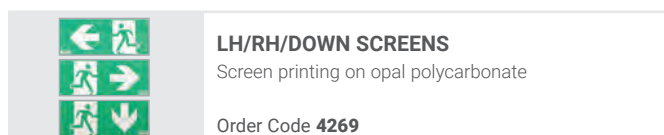
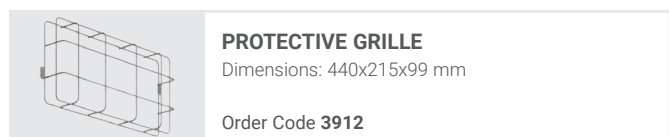
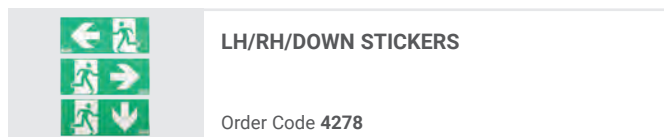
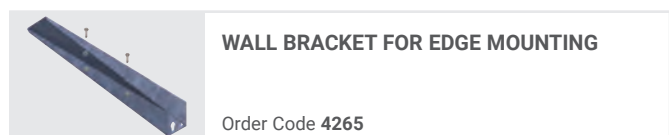
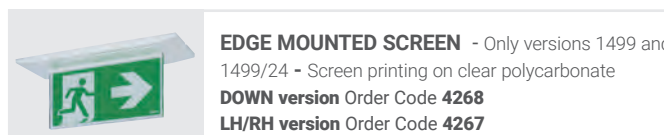



# Metrica

emergency



IP65

IK07

850°



Batt. LTO

+45°C  
-20°C



Luminous flux up to 1600lm and adjustable autonomy, with a fast-charging Titanium battery, with 10 years of service life and for extreme working temperatures.



Optics designed to direct the light beam towards the ground. An additional beam-controlled lens designed for escape routes is fitted as standard. When removing the lens, the beam width is ideal for overhead mounting.

## Applications

Services, also for applications in design environments

## Characteristics

**Power supply\*** 230VAC ± 10%, 50÷60Hz

**Mounting** Wall, recessed

**Recharging time** 12h

**Housing** Polycarbonate, white RAL 9003

**Optics** Anti-glare aluminium

**Screen** Clear polycarbonate

**Compliance** EN 60598-1, EN 60598-2-2, EN 60598-2-22, UNI EN 1838, UNI 11222, EN 62034

\* LG230, LG24, HT systems consider the parameters of the control unit used

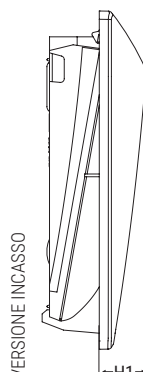
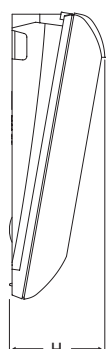
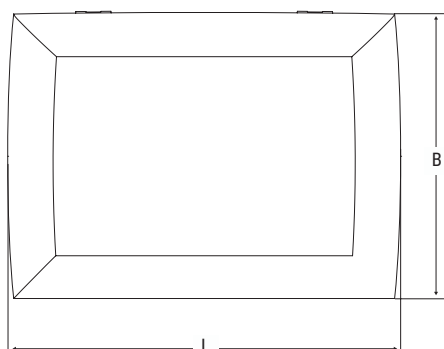

Version	Dimensions mm			
	L	B	H	H1
L	213	155	62	-
XL	355	180	58	-
L - recessed mounting kit	240	184	-	25
XL - recessed mounting kit	388	213	-	30

## Reference standard UNI EN 1838

Lens	Height (m)	Centre distance (m) ESCAPE ROUTES		Illuminated surface area (m) LARGE AREAS	
		Wall	Ceiling	Wall	Ceiling
Present	2.5	16	-	-	-
Removed	2.5	-	-	7x10	-

Lighting >1lx at floor level along the centre line without reflections Emax/Emin <40

Lighting >0.5lx at floor level without reflections Emax/Emin <40

Performance with reference to luminaire Order Code 19421 800lm - Maintenance coefficient 0.8

## METRICA WITH LENS

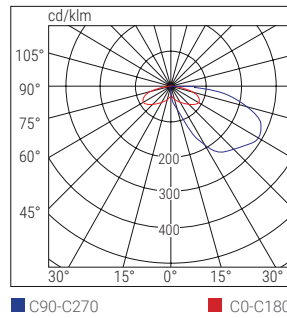

## METRICA WITHOUT LENS

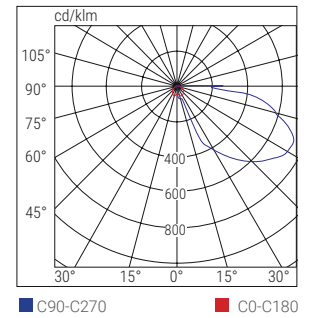

	Order Code	W eq.	Description	Version	Autonomy h	Battery	FLUX SE lm	Batt. AUTORIPARA SUPPLIED Flux SE lm	FLUX SA lm	Input power		Weight Kg	Packaging Single/ Multi pack
										DC	AC		
LG	19420	11	METRICA LED LGAR/ SA/PS LTO L	SA/SE/PS	1/1.5/3*	LTO 9.6V 0.5Ah	260	600/400/200	250	6.8W	8.6VA	0.8	1/12
	19421	36	METRICA LED LGAR/ SA/PS LTO XL	SA/SE/PS	1/1.5/3*	LTO 9.6V 1.2Ah	530	1600/1100/550	800	11.3W	12.6VA	1	1/12
	LGFM	Standalone luminaires with Centralised Radio Diagnostics integrating the Module Order Code 15037											
	DALI	Standalone luminaires with Dali Centralised Diagnostics integrating the Module Order Code 15038											
LG230	31121	11	METRICA LED LGS230 L						550	6.8W	8.6VA	0.7	1/12
	31123	36	METRICA LED LGS230 XL						1100	11.3W	12.6VA	0.8	1/6
LG24	32090	11	METRICA LED LGS24 L				260		550	3W	6.8VA	0.7	1/12
	32093	36	METRICA LED LGS24 XL				530		1100	4.3W	11.1VA	0.8	1/6
HT230	17423	11	METRICA LED HT L						550	6.3W	6.8VA	0.7	1/12
	17424	36	METRICA LED HT XL						1100	11W	11.1VA	0.8	1/6

\* The indicated flux and autonomy refer to the luminaire set in HIGH FLUX mode - with the LONG OPERATING TIME setting, the autonomy doubles and the flux is reduced.

## ACCESSORIES - included



**AR LTO 9.6V 1.2Ah BATTERY SYSTEM**  
Compatible with Order Code 19421

Order Code **RA04**



**CABLE CONDUIT GLAND PG16/PG20**  
Removable for overhead mounting

Order Code **3727**



**AR LTO 9.6V 0.5Ah BATTERY SYSTEM**  
Compatible with Order Code 19420

Order Code **RA05**



**LH/RH/DOWN STICKERS**  
XL version only

Order Code **12941**

## ACCESSORIES - to be ordered separately



**RECESSED MOUNTING KIT**

Order Code **12942** (Version L )  
Order Code **12943** (Version XL )



**LGFM - DALI MODULE (LG version only)**

**LGFM** - Order Code **15037**  
**DALI** - Order Code **15038**

**LGFM** **DALI**



**LG INIBIT REMOTE CONTROL**  
RM for LG versions only

Order Code **12101**

**LG**

# Lungalargaluce

emergency



IP41

IK07

850°

Batt. LTO  
+45°C  
-20°C



Reduced aesthetic impact for a multi-purpose ceiling-mounted luminaire just 3 cm thick.



A single luminaire for evacuation routes up to more than 17m and for panic areas up to 130sqm. Ceiling mounting, but also wall mounting, thanks to the specific Diffusaluce lens. Adjustable autonomy from 1 to 8 hrs.



Three lenses supplied with different light beams. Optional asymmetrical accent lens for illuminating fire fighting and protective equipment.



Quick installation without any recessed holes.

## Applications

Industry, services, warehouses, schools, hospitals, shops, shopping centres, offices

## Characteristics

**Power supply\*** 230VAC ± 10%, 50÷60Hz

**Mounting** Ceiling

**Recharging time** 12h

**Housing** Polycarbonate, white RAL 9010

**Optics** Highly transparent PMMA lenses

**Compliance** EN 60598-1, EN 60598-2-22, UNI EN 1838, UNI 11222, EN 62034

\* LG230, LG24, HT systems consider the parameters of the control unit used

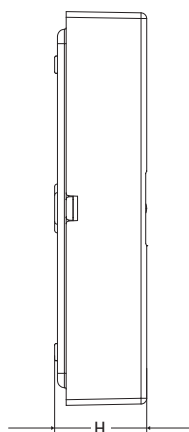
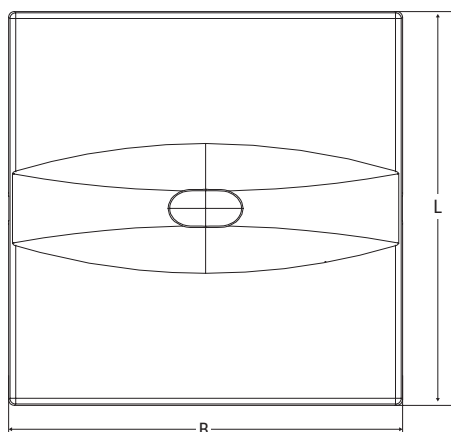

Dimensions mm

L	B	H
137	137	32

046

# Reference standard UNI EN 1838

Lens	Height (m)	Centre distance (m) ESCAPE ROUTES		Illuminated surface area (m) LARGE AREAS	
		Wall	Ceiling	Wall	Ceiling
Lungaluce	3	-	20	-	-
Largaluce	3	-	-	-	12x12

Lighting >1lx at floor level along the centre line without reflections Emax/Emin <40

Lighting >0.5lx at floor level without reflections Emax/Emin <40

Performance with reference to luminaire Order Code 19329 450lm Maintenance coefficient 0.8



## LUNGALUCE 87%

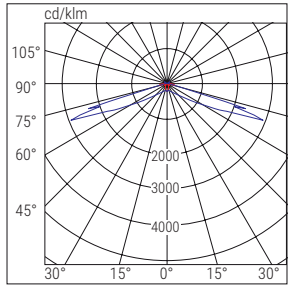

■ C90-C270 ■ C0-C180

## LARGALUCE 95%

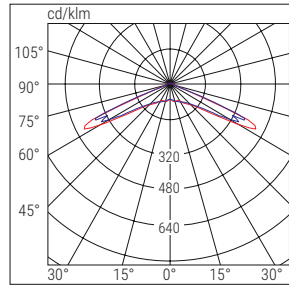

■ C90-C270 ■ C0-C180

## DIFFUSALUCE 85%

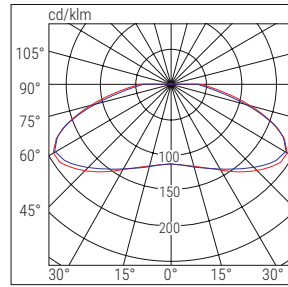

■ C90-C270 ■ C0-C180

	Order Code	W eq.	Description	Version	Autonomy h	Battery	FLUX SE lm	FLUX SA lm	Input power		Weight Kg	Packaging Single/ Multi pack	Conform.
									DC	AC			
AT - OPT	19328	24	L.LARG DWCL AT OPT 24W SA LTO	SA/SE	1/1.5/2/3/8	LTO 7.2V 0.5AH	250/200/150/80/50	220		5W		1/6	CENTRALISED SELF-TESTING
	19329	24GL	L.LARG DWCL AT OPT GL SA LTO	SA/SE	1/1.5/2/3/8	2x LTO 7.2V 0.5AH	450/330/250/160/170	220		5W		1/6	
	<b>LG</b>	Standalone luminaires with Centralised Diagnostics integrating the Module Order No. 15036											
	<b>LGFM</b>	Standalone luminaires with Centralised Radio Diagnostics integrating the Module Order Code 15037											
	<b>DALI</b>	Standalone luminaires with Dali Centralised Diagnostics integrating the Module Order Code 15038											
LG230	17876	24	LLARGA DWCL LGS230					380	4.1W	8.3VA		1/6	CENTRALISED BATTERY
LG24	17877	24	LLARGA DWCL LGS24 LS-UV				380	380	3.8W			1/6	
HT230	19320	24	L.LARG DWCL HT 24W					380	4.8W	9.6VA		1/6	

\* The fluxes shown refer to the luminaire without lens. To identify the actual flux of the product, please consider the yield percentage indicated in the lens photometry in addition to the value shown in the table.

## ACCESSORIES - included

	<b>LUNGALUCE LENS</b>
	<b>LARGALUCE LENS</b>
	<b>DIFFUSALUCE LENS</b>

## ACCESSORIES - to be ordered separately

	<b>LG - LGFM - DALI MODULE</b> (AT-OPT version only) <b>LG</b> - Order Code <b>15036</b> <b>LGFM</b> - Order Code <b>15037</b> <b>DALI</b> - Order Code <b>15038</b>
	<b>LARGALUCE LENS 7m</b>  Order Code <b>F95819</b>
	<b>LARGALUCE LENS 12m</b> - Order Code <b>F95808</b>
	<b>LUNGALUCE LENS 12m</b> - Order Code <b>F95807</b>
	<b>ASIMMETRICA* LENS</b> - Order Code <b>F95815</b>

Lens photometry and fluxes are available in the electronic catalogue on begelli.com.

# Lungalargaluce-recessed mounting

emergency



 Recessed luminaire with multi-purpose beam and very low aesthetic impact.

 A single luminaire for escape routes up to more than 17m and for panic areas up to 130sqm. Adjustable autonomy from 1 to 8 hrs.

 Two lenses supplied. Optional asymmetrical accent lens for illuminating fire fighting and protective equipment.

 Extremely quick mounting thanks to steel springs that allow orientation even after installation. Recessed hole  $\varnothing$  80±100mm.

## Applications

Services, offices, cinemas, hotels, museums, schools, shops, shopping centres, design rooms

## Characteristics

**Power supply\*** 230VAC  $\pm$  10%, 50÷60Hz

**Mounting** False ceiling, recessed

**Recharging time** 12h

**Housing** Polycarbonate, white RAL 9010

**Optics** Highly transparent PMMA lenses

**Compliance** EN 60598-1, EN 60598-2-2, EN 60598-2-22, UNI EN 1838, UNI 11222, EN 62034

\* LG230, LG24, HT systems consider the parameters of the control unit used

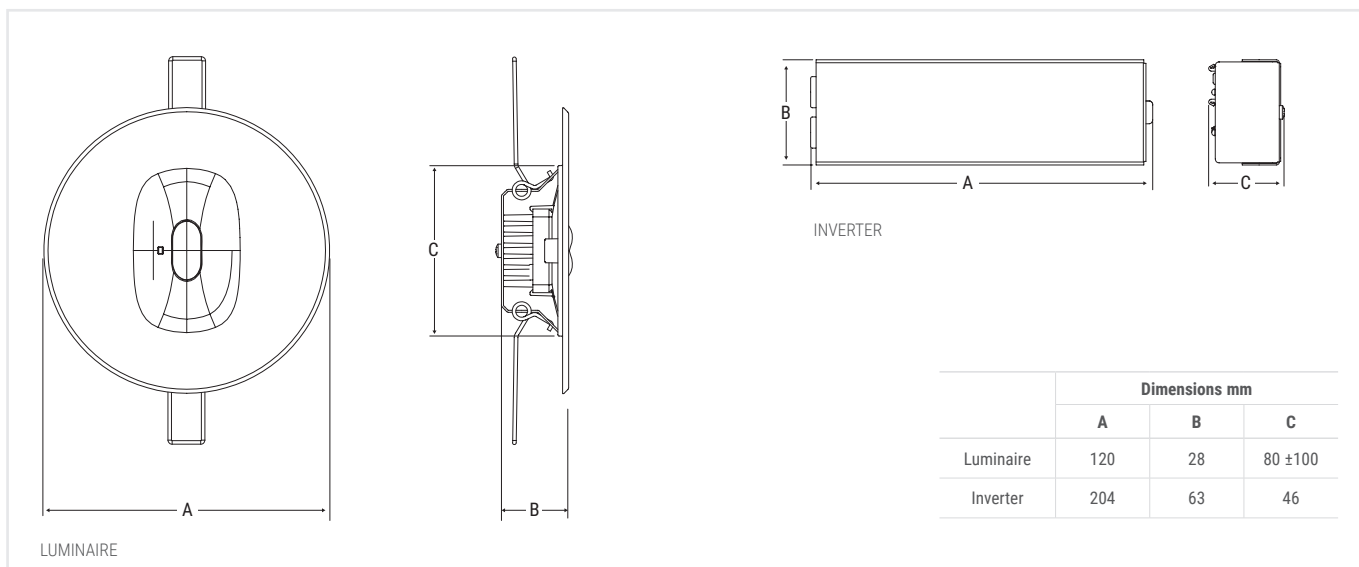



# Reference standard UNI EN 1838

Lens	Height (m)	Centre distance (m) ESCAPE ROUTES		Illuminated surface area (m) LARGE AREAS	
		Wall	Ceiling	Wall	Ceiling
Lungaluce	3	-	20	-	-
Largaluce	3	-	-	-	12x12
Lighting >1lx at floor level along the centre line without reflections Emax/Emin <40				Lighting >0.5lx at floor level without reflections Emax/Emin <40	
Performance with reference to luminaire Order Code 19339 450lm				Maintenance coefficient 0.8	

## LUNGALUCE

87%

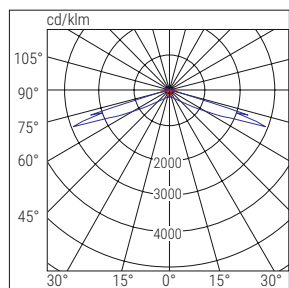

■ C90-C270    ■ C0-C180

## LARGALUCE

95%

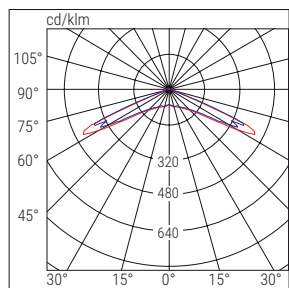

■ C90-C270    ■ C0-C180



	Order Code	W eq.	Description	Version	Autonomy h	Battery	FLUX SE lm	FLUX SA lm	Input power		Weight Kg	Packaging Single/ Multi pack	Conform.
									DC	AC			
AT - OPT	19338	24	LLARG DWRC AT/OPT 24W SA LTO	SA/SE	1/1.5/2/3/8	LTO 7.2V 0.5AH	250/200/150/80/50	220	5W		1/6		CENTRALISED SELF-TESTING
	19339	24GL	LLARG DWRC AT/OPT 24W GL SA LTO	SA/SE	1/1.5/2/3/8	2x LTO 7.2V 0.5AH	450/330/250/160/70	220	5W		1/6		
	LG	Standalone luminaires with Centralised Diagnostics integrating the Module Order No. 15036											
	LGFM	Standalone luminaires with Centralised Radio Diagnostics integrating the Module Order Code 15037											
	DALI	Standalone luminaires with Dali Centralised Diagnostics integrating the Module Order Code 15038											
LG230	17878	24	L.LARGA DWRC LGS230					380	4.1W	8.3VA		1/6	CENTRALISED BATTERY
LG24	17879	24	L.LARGA DWRC LGS24 LS-UV				380	380	3.8W			1/6	
HT230	19330	24	L.LARG DWRC HT 24W					380	4.8W	9.6VA		1/6	

\* The fluxes shown refer to the luminaire without lens. To identify the actual flux of the product, please consider the yield percentage indicated in the lens photometry in addition to the value shown in the table.

## ACCESSORIES - included



## ACCESSORIES - to be ordered separately

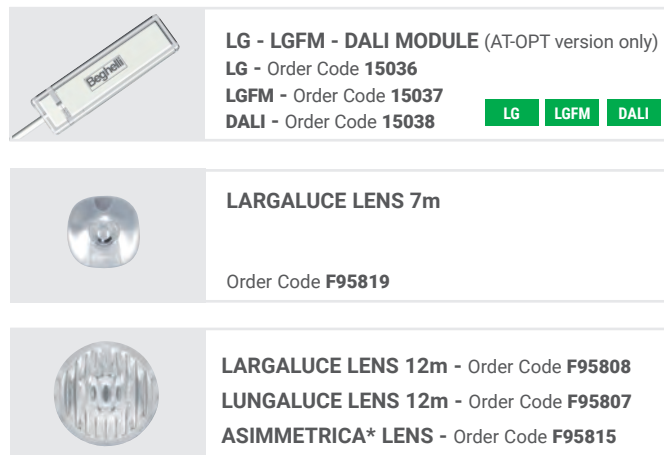



Lens photometry and fluxes are available in the electronic catalogue on begelli.com.

# Multi Lens

emergency



 Minimal aesthetic impact and high performance with a 10-year warranty.

 A single luminaire for escape routes up to 12m and for panic areas up to 90sqm. Adjustable autonomy from 1 to 8 hrs.

 Three interchangeable lenses supplied for mounting from 3 to 7m high, with different light beams.

 Springs for quick fastening to false ceilings.  
Recessed hole  $\varnothing$ 60 mm.

## Applications

Services, offices, cinemas, hotels, schools, shops, shopping centres, showrooms

## Characteristics

**Power supply** 230VAC  $\pm$  10%, 50÷60Hz

**Mounting** Recessed

**Recharging time** 12h

**Housing** Polycarbonate

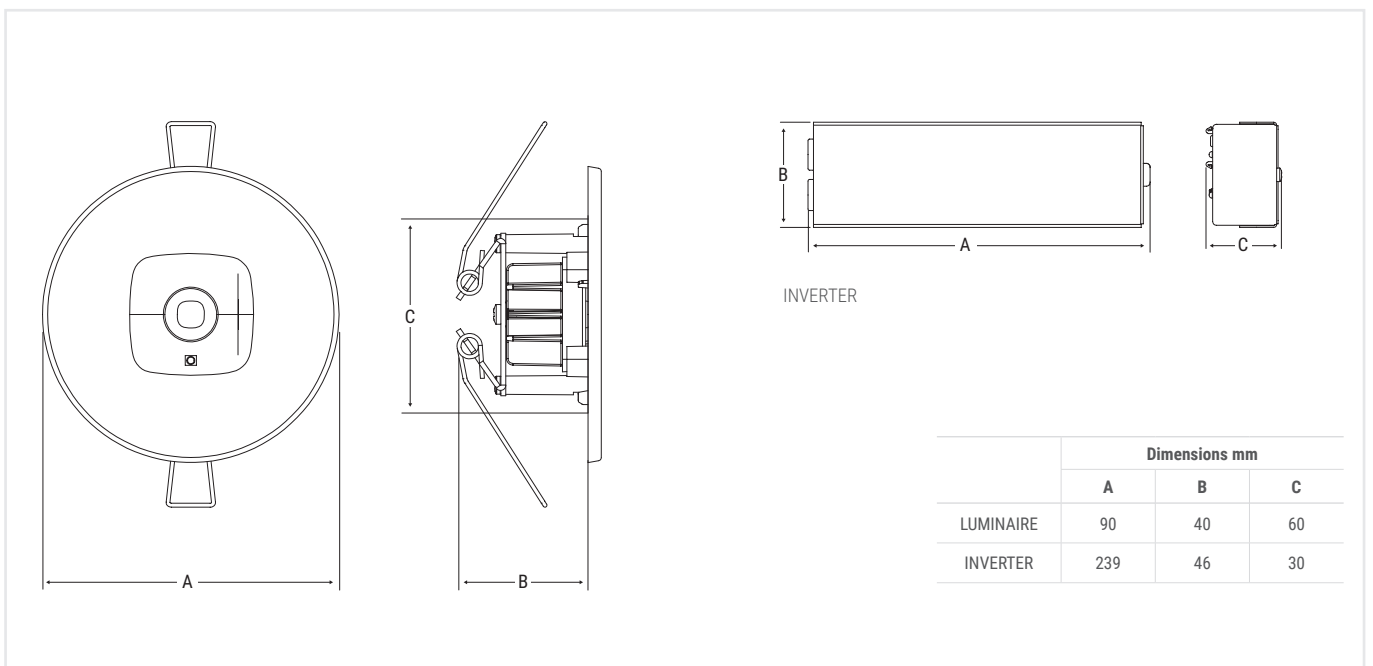

**Optics** Highly transparent PMMA lenses

**Compliance** EN 60598-1, EN 60598-2-2, EN 60598-2-22, UNI EN 1838, UNI 11222, EN 62034



050

# Reference standard UNI EN 1838

Lens	Height (m) 	Centre distance (m) ESCAPE ROUTES 		Illuminated surface area (m) LARGE AREAS 		
		Wall	Ceiling	Wall	Ceiling	
Lungaluce	3	-	17	-	-	
Largaluce	3	-	-	-	12x12	
Altaluce	7	-	15	-	-	
			Lighting >1lx at floor level along the centre line without reflections Emax/Emin <40		Lighting >0.5lx at floor level without reflections Emax/Emin <40	
Performance with reference to luminaire Order Code 4334 450lm				Maintenance coefficient 0.8		

## LUNGALUCE

87%

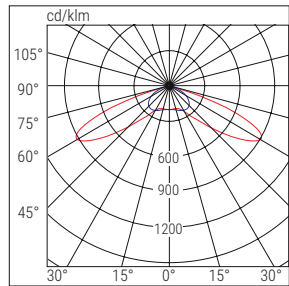

■ C90-C270 ■ C0-C180

## LARGALUCE

92%

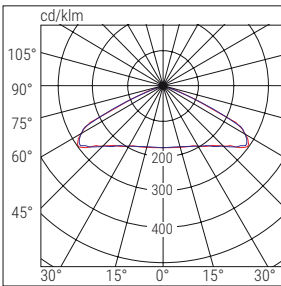

■ C90-C270 ■ C0-C180

## ALTALUCE

85%

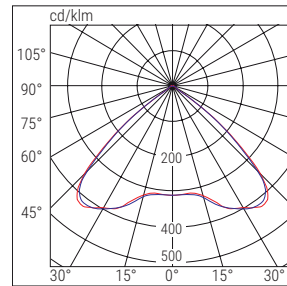

■ C90-C270 ■ C0-C180

	Order Code	W eq.	Description	Version	Autonomy h	Battery	FLUX SE lm	FLUX SA lm	Input power		Weight Kg	Packaging Single/ Multi pack
									DC	AC		
TR	4330	24	MULTI LENS 60MM SE 1h RM	SE	1	LiFe 3.2V 1.5Ah	250			1W	0.4	1/6
	4331	11	MULTI LENS 60MM SE 3h RM	SE	3	LiFe 3.2V 1.5Ah	90			1.5W	0.4	1/6
	4334	24GL	MULTI LENS GL 60MM SA 1/2/3h RM	SA/SE	1/2/3	LiFe 3.2V 1.5Ah	450/250/150	220		3W	0.4	1/6
	4335	24GL	MULTI LENS GL 60MM SA 2/3/6h RM	SA/SE	2/3/6	LiFe 3.2V 3Ah	450/300/150	220		3W	0.4	1/6
AT - OPT	4390	24	MULTI LENS AT OPT SE 8LTO	SE	1/1.5/2/3/8	LTO 7.2V 0.5AH	250/200/150/80/50			3.5W	0.4	1/6
	4391	24	MULTI LENS AT OPT SA 8LTO	SA/SE	1/1.5/2/3/8	LTO 7.2V 0.5AH	250/200/150/80/50	220		5W	0.4	1/6
	4393	24GL	MULTI LENS GL AT OPT SA 8LTO	SA/SE	1/1.5/2/3/8	2xLTO 7.2V 0.5AH	450/330/250/160/170	220		5W	0.4	1/6
	LG	Standalone luminaires with Centralised Diagnostics integrating the Module Order No. 15036										
LGFM	Standalone luminaires with Centralised Radio Diagnostics integrating the Module Order Code 15037											
DALI	Standalone luminaires with Dali Centralised Diagnostics integrating the Module Order Code 15038											

## ACCESSORIES - included

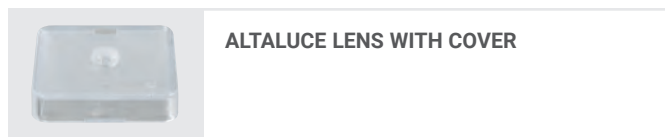
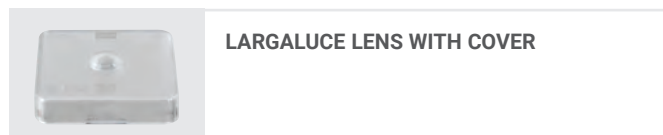
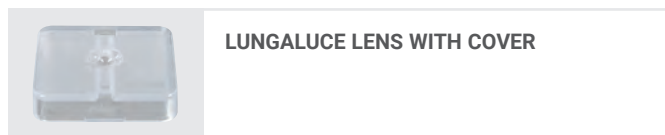

## ACCESSORIES - to be ordered separately

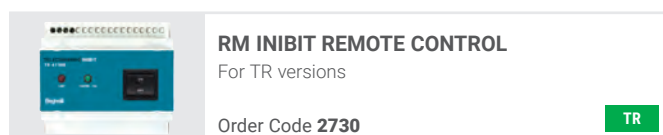
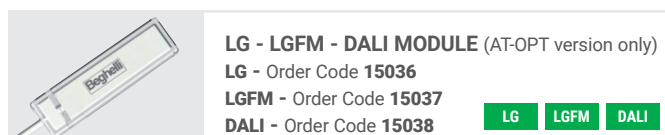

# Lumax 65

emergency



Titanium battery for fast charging and a long luminaire lifespan. High luminous flux with diffuse emission



Lighting and emergency lighting integrated with multiple control systems, both self-contained and centralised



Available version with microwave motion sensor for automatic lighting activation

## Applications

Indoor, outdoor, services, residential buildings, stairwell lighting, corridors, shops, hotels, restaurants

## Characteristics

**Power supply\*** 230VAC  $\pm$  10%, 50÷60Hz

**Mounting** Wall, ceiling

**Recharging time** 12h

**Housing** Polycarbonate, grey RAL 9006

**Screen** Opal polycarbonate

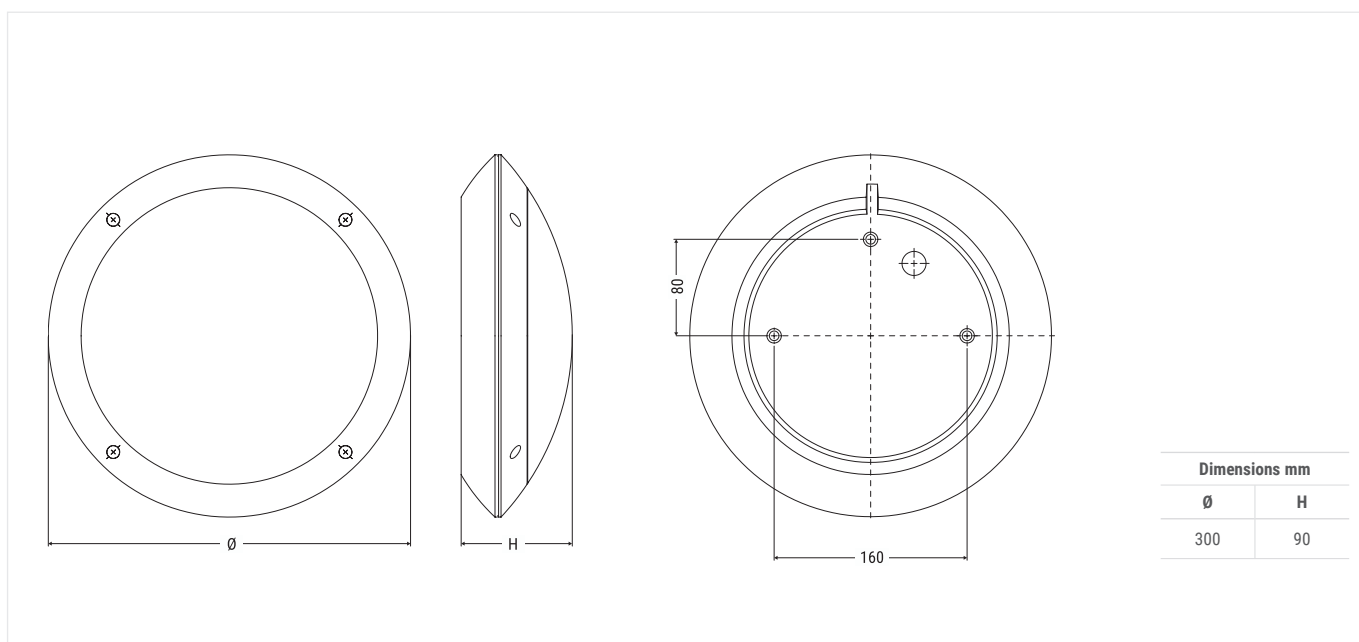

**Compliance** EN 60598-1, EN 60598-2-22, UNI EN 1838, UNI 11222, EN 62034

\* LG230, LG24, HT systems consider the parameters of the control unit used



052

## Performance according to EN 1838

Height (m) 	Centre distance (m) ESCAPE ROUTES 		Illuminated surface area (m) LARGE AREAS 	
	Wall	Ceiling	Wall	Ceiling
2.5	6	-	6x6	-
3	-	10	-	6x6
Lighting >1lx at floor level along the centre line without reflections Emax/Emin <40			Lighting >0.5lx at floor level without reflections Emax/Emin <40	
Performance with reference to luminaire Order Code 37126 278 lm			Maintenance coefficient 0.8	

## LUMAX 65

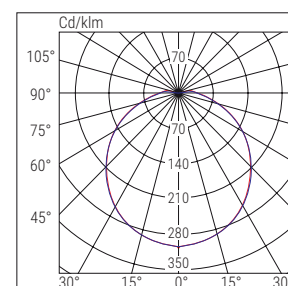

■ C0-C180

■ C90-C270

	Order Code	W eq.	Description	Version	Autonomy h	Battery	FLUX SE lm	FLUX SA lm	Input power		Weight Kg	Packaging Single/Multi pack
									DC	AC (SE/SA)		
AT	37126		LUMAX65 GR SA/SE AT 4K	SA/SE	1/3/8	2 x LTO 7.2V 0.5Ah	278/140/38	1500		2.5/18W		AUTOTEST
	37236*		LUMAX65 GR SA/SE AT 4K MW	SA/SE	1/3/8	2 x LTO 7.2V 0.5Ah	278/140/38	1500		2.5/18W		
LG	37127		LUMAX65 GR SA/SE LG 4K	SA/SE	1/3/8	2 x LTO 7.2V 0.5Ah	278/140/38	1500		2.5/18W		CENTRALTEST
	37237*		LUMAX65 GR SA/SE LG 4K MW	SA/SE	1/3/8	2 x LTO 7.2V 0.5Ah	278/140/38	1500		2.5/18W		
LGFM	37128		LUMAX65 GR SA/SE LGFM 4K	SA/SE	1/3/8	2 x LTO 7.2V 0.5Ah	278/140/38	1500		2.5/18W		CENTRALTEST
	37238*		LUMAX65 GR SA/SE LGFM 4K MW	SA/SE	1/3/8	2 x LTO 7.2V 0.5Ah	278/140/38	1500		2.5/18W		
LG230	31090		LUMAX65 GR S230 SA/SE 4K	SA/SE				1500	18.5W	19.5VA		CENTRALISED BATTERY
	31208		LUMAX65 GR S230 SA/SE 4K MW	SA/SE				1500	18.5W	19.5VA		
LG24	32067		LUMAX65 GR S24 SA/SE 4K	SA/SE			280	1500	4.3W	18VA		CENTRALISED BATTERY
	32122*		LUMAX65 GR S24 SA/SE 4K MW	SA/SE			280	1500	4.3W	18VA		
HT230	31092		LUMAX65 GR HT 4K					1500	17W	18VA		CENTRALISED BATTERY
	31210*		LUMAX65 GR HT 4K MW					1500	17W	18VA		

\* Version with built-in microwave motion sensor

## ACCESSORIES - to be ordered separately



**LG INIBIT REMOTE CONTROL**  
RM for LG versions only

Order Code **12101** LG





# TuttiFrutti

emergency



IP40

IK05

850°



Batt. LiFe

+40°C  
0°C

Batt. NiCd

+40°C  
0°C



Advanced emergency system for all popular emergency luminaires for wiring systems.



Light sensor for automatic activation in night mode.



Triple reflective system for lighting, status LED display and activation of the light sensor in protected mode from other artificial sources.



Patented fixing system that fits all emergency luminaires for wiring systems. Mounting does not require a replacement of the existing frame and/or plate. Anchoring is done directly on the holes of the wall recess-mounted box (503/506) only.

## Applications

Residential and services, either emergency lighting or night lighting, as well as spotlight

## Characteristics

**Power supply** 230VAC  $\pm$  10%, 50÷60Hz

**Mounting** recessed (box 506)

**Recharging time** 12h with LiFe battery

**Housing** Polycarbonate

**Optics** PC, asymmetrical, metallic

**Screen** Clear polycarbonate

**Compliance** EN 60598-1, EN 60598-2-2, EN 60598-2-22, UNI EN 1838, UNI 11222, EN 62034

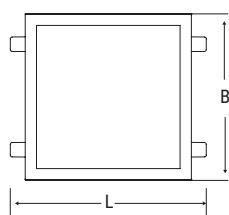

TUTTIFRUTTI 2

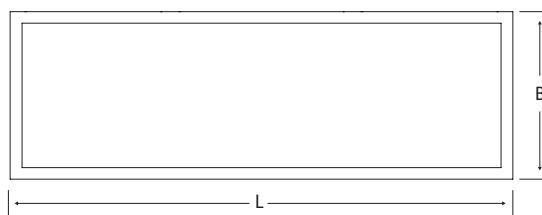

TUTTIFRUTTI 6

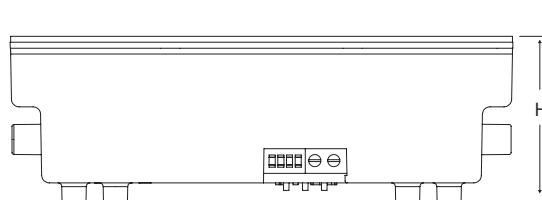
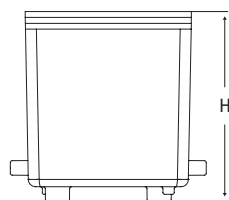

Version	Dimensions mm		
	L	B	H
TUTTIFRUTTI 2	52	44	54
TUTTIFRUTTI 6	132	44	44

## TUTTIFRUTTI 2

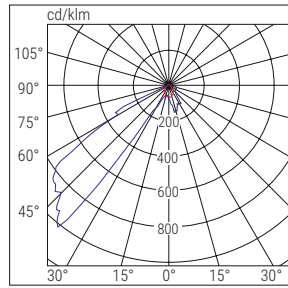
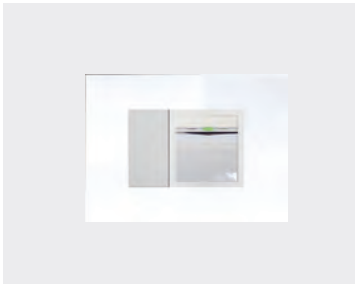

■ C90-C270 ■ C0-C180

## TUTTIFRUTTI 6

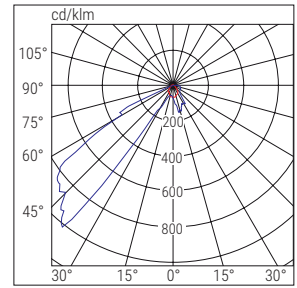

■ C90-C270 ■ C0-C180

	Order Code	Description	Version	Autonomy h	Battery	FLUX SE lm	FLUX SA lm	Input power		Weight Kg	Packaging Single/Multi pack
								DC	AC		
TR	<b>TUTTIFRUTTI 2</b>										
	4607	TUTTIFRUTTI 2-3 LED SE 2h	SE	2	LiFe 3.2V 0.2Ah	30				0.7W	0.25
TR	<b>TUTTIFRUTTI 6</b>										
	4609	TUTTIFRUTTI 6 LED SE 2h	SE	2	NiCd 3.6V 0.4Ah	70	-			0.7W	0.25



055 emergency luminaries for wiring systems

# Fruttoluce

emergency

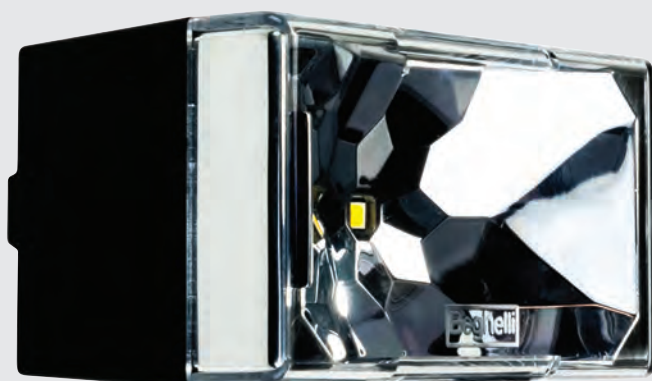

Residential emergency system with modules of 1, 2, 3 and 6 electrical contact blocks.



Light sensor for automatic activation in night mode. 3 x electrical contact blocks pull-out version.



Triple reflective system for lighting, status LED display and activation of the light sensor in protected mode from other artificial sources.



Each luminaire is equipped with adapters for mounting on the most common emergency luminaires for wiring systems.

## Applications

Services and residential, for emergency lighting or night lighting and as steplight

## Characteristics

**Power supply** 230VAC  $\pm$  10%, 50-60Hz

**Mounting** Wall as steplight, wall as night light, wall as emergency lighting

**Housing** Polycarbonate

**Optics** Asymmetrical, metallic

**Screen** Clear polycarbonate

**Compliance** EN 60598-1, EN 60598-2-2, EN 60598-2-22, UNI EN 1838, UNI 11222, EN 62034

IP40

IK05

850°



Batt. NiCd  
+40°C  
0°C

Batt. Li-ion  
+40°C  
0°C

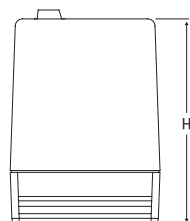
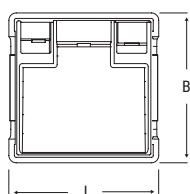

FRUTTOLUCE 1-2

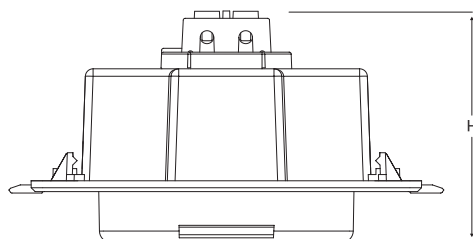
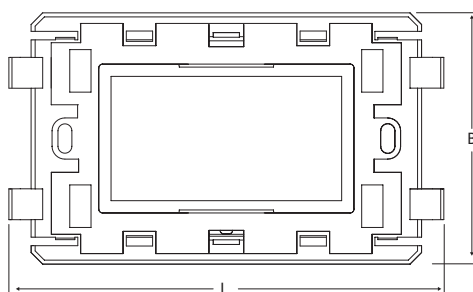

FRUTTOLUCE 3-6

Version	Dimensions mm		
	L	B	H
FRUTTOLUCE 1	19	41	56.5
FRUTTOLUCE 2	41	41	56.5
FRUTTOLUCE 3	112	65	60
FRUTTOLUCE 6	187	70	40

## FRUTTOLUCE 1

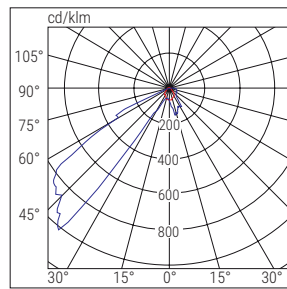
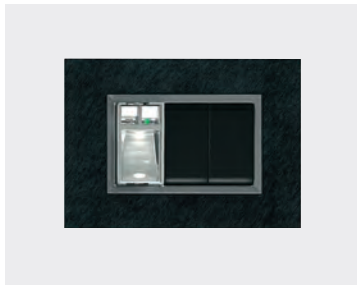

■ C90-C270 ■ C0-C180

## FRUTTOLUCE 2

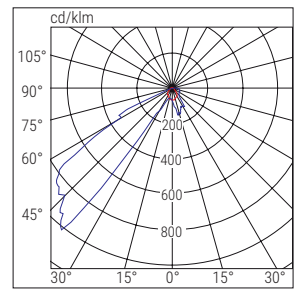
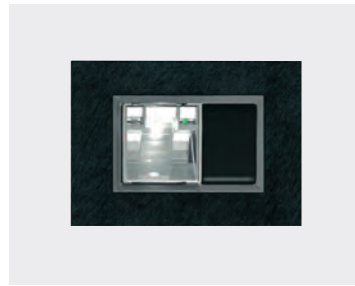

■ C90-C270 ■ C0-C180

## FRUTTOLUCE 3

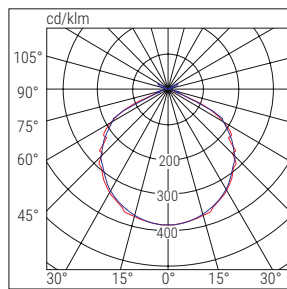
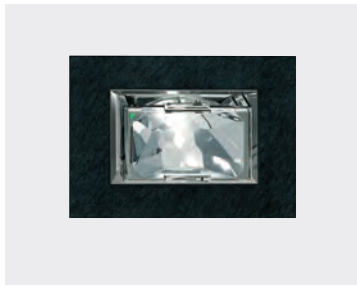

■ C0-C180 ■ C90-C270

## FRUTTOLUCE 6

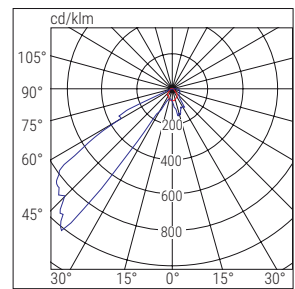
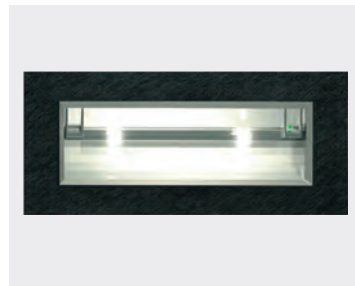

■ C90-C270 ■ C0-C180

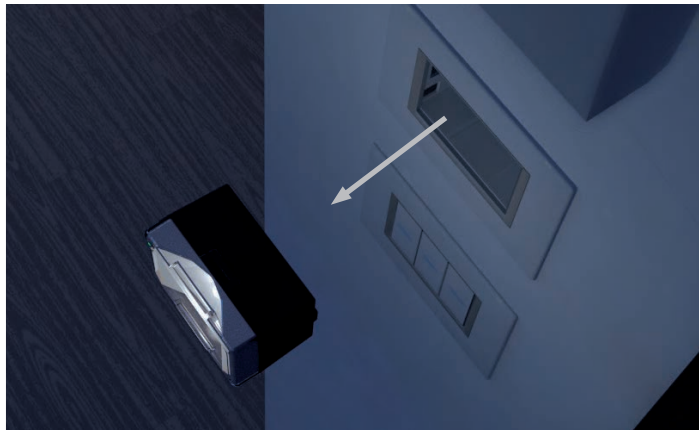

### FRUTTOLUCE 3

#### EXTRACTABLE TORCH FOR DOMESTIC USE

FruttoLuce3 can be conveniently removed from the mount to bring light where it is needed. The unlocking system facilitates the extraction of the torch while ensuring a maximum safety of the power supply terminal block.

	Order Code	Description	Version	Autonomy h	Battery	FLUX SE lm	FLUX SA lm	Input power		Weight Kg	Packaging Single/ Multi pack	
								DC	AC			
TR	<b>FRUTTOLUCE 1</b>											
	4601	FRUTTOLUCE1 LED SE/SA 1N	SA/SE	1	Li-ion 3.2V 0.1Ah				0.5W	0.1	12	
	<b>FRUTTOLUCE 2</b>											
	4602	FRUTTOLUCE2 LED SE/SA 1N	SA/SE	1	NiCd 2.4V 0.4Ah				0.8W	0.13	12	
<b>FRUTTOLUCE 3</b>												
	4603	FRUTTOLUCE3 LED SE/SA 1N	SA/SE	1	NiCd 2.4V 0.4Ah				0.4W	0.2	12	
<b>FRUTTOLUCE 6</b>												
	4605	FRUTTOLUCE6 LED 4605-SE/SA 1N	SA/SE	1	NiCd 4.8V 0.4Ah				1W	0.2	12	

STANDARD

# Linea 500

emergency



IP40

IK05

850°



Batt. NiCd

+40°C  
0°C



Residential emergency for boxes 503 and 506, hole cover plate supplied.



Also suitable for use as a steplight in public places of entertainment.

## Applications

Residential and services, also in premises used for public entertainment

## Characteristics

**Power supply** 230VAC  $\pm$  10%, 50÷60Hz

**Mounting** Recessed

**Housing** Polycarbonate

**Optics** Symmetrical, metallic

**Screen** Clear polycarbonate

**Plate** Polycarbonate, RAL 9003

**Compliance** EN 60598-1, EN 60598-2-2, EN 60598-2-22, UNI EN 1838, UNI 11222, EN 62034

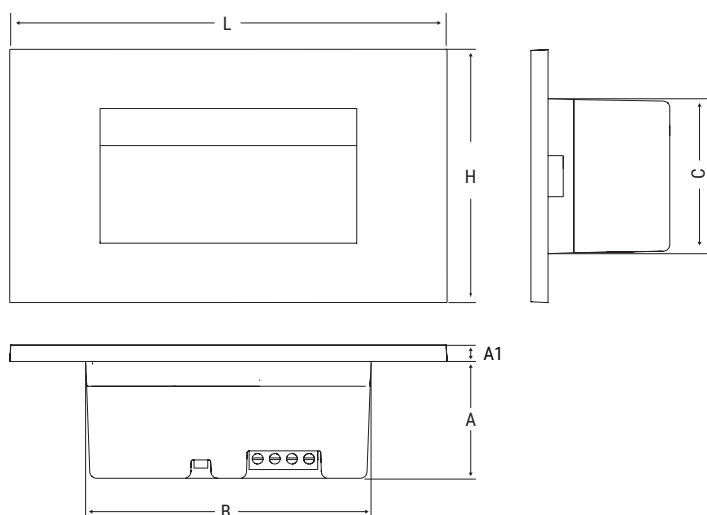

Version	Dimensions mm					
	L	H	B	A	A1	C
LINEA 503	118	76	78	36	5	49
LINEA 506	209	76	164	35	5	47

058



## LINEA 503

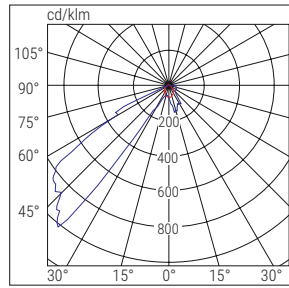
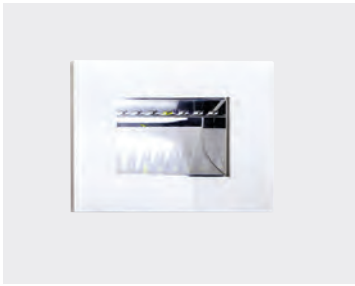

■ C90-C270      ■ C0-C180

## LINEA506

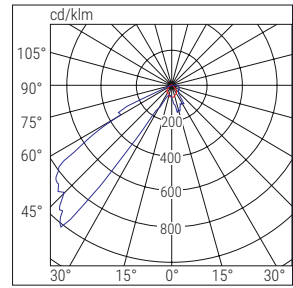

■ C90-C270      ■ C0-C180

	Order Code	Description	Version	Autonomy h	Battery	FLUX SE lm	FLUX SA lm	Input power		Weight Kg	Packaging Single/Multi pack
								DC	AC		
TR	LINEA 503										
	4611	LINEA 503 LED SE 2h	SE	2	NiCd 3.6V 0.4Ah	60			0.8W	0.4	1/12
	LINEA 506										
	4612	LINEA 506 LED SE 1h	SE	1	NiCd 3.6V 0.4Ah	40			0.8W	0.4	1/12

STANDARD

## ACCESSORIES - included

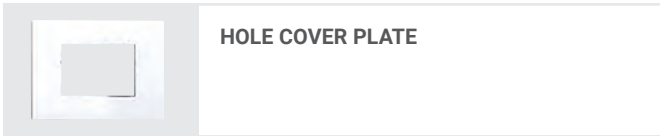

059 emergency luminaires for wiring systems

# Placca Brain Classic Emergenza

emergency



Light plate with 15 colours that can be adjusted to different levels of light intensity. Equipped with battery for emergency lighting.



Steplight, night lighting, emergency lighting function.



Double battery of high intensity RGB LEDs with lighting scheme and light diffusion pattern, backlight type.



It can be installed on all the most common emergency luminaires for wiring systems using the existing electrical contact blocks and frame. White and black versions.

## Applications

Residential, services, luxury hotels, showrooms, designer restaurants

## Characteristics

**Power supply\*** 230VAC  $\pm$  10%, 50÷60Hz

**Mounting** On box 503

**Housing** Polycarbonate, white RAL 9003

**Diffuser** PMMA

**Compliance** EN 60598-1, EN 60598-2-22

IP20 IK05 850° +40°C / 0°C Batt. Li-ion 15 RGB settable colours

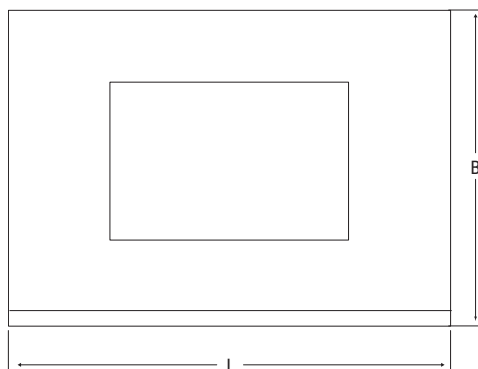

PLATE FOR BOX 503



BATTERY FOR EMERGENCY LIGHTING

	Dimensions mm		
	L	B	H
PLATE	126	90	12
BATTERY	45	9	6

## NIGHT LIGHT

Light sensor with selectable colour and intensity modes, differentiated for day and night.

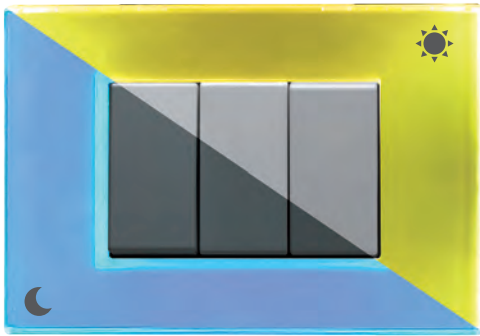

## COMPATIBILITY WITH THE MOST POPULAR EMERGENCY LUMINARIES FOR WIRING SYSTEMS

BTicino Axolute - BTicino Axolute AIR - BTicino Light - BTicino Living Light - BTicino Living Light AIR - BTicino Living International - Vimar Plana - Vimar Arkè Vimar Eikon - Vimar Eikon EVO - Gewiss Chorus - AVE Sistema 44 - ABB Chiara - ABB Mylos.

The trademarks mentioned in the table are registered trademarks of their respective owners. The luminaire series mentioned, with which the "BRAIN" plates are mechanically compatible, have their own original plates.

	Order Code	Description	Version	Autonomy h	Battery	FLUX SE lm	FLUX SA lm	Input power		Weight Kg	Packaging Single/Multi pack
								DC	AC		
TR	81143	BRAIN CLASSIC EM 3F PLATE, WHITE	SA/SE	1	Li-ion 3.7V 0.5Ah				1.5W	0.1	1/12
	81144	BRAIN CLASSIC EM 3F PLATE, BLACK	SA/SE	1	Li-ion 3.7V 0.5Ah				1.5W	0.1	1/12

## ACCESSORIES - included



**CLASSIC BATTERY**

Order Code **81296E**

TR



**ADAPTER SERIES**

For mounting in all common emergency luminaires for wiring systems

## ACCESSORIES - to be ordered separately



**SPECIAL ADAPTERS**

For BTicino Matix series, Living 1st series, Vimar Idea

Order Code **81236** (white)

Order Code **81237** (black)



# Acciaio emergenza

emergency



IP66

IK09

850°

Batt. LiFe  
+40°C  
0°C

Batt. NiMH  
+40°C  
0°C

Batt. ICE PACK  
+40°C  
-40°C



Luminaire characterised by high mechanical and chemical resistance and a luminous flux of up to 1800lm.



Reflector with 4 separate anti-glare cells and micro-prismatic glass screen with high light transmission.



Easy installation with steel hooks, quick access to the wiring system.

## Applications

Industrial, high-risk areas including explosive atmospheres, outdoors

## Characteristics

**Power supply\*** 230VAC  $\pm$  10%, 50÷60Hz

**Mounting** Wall, ceiling, suspended, electrified track

**Recharging time** 12h with LiFe battery

**Housing** Pre-galvanised sheet steel, powder-coated RAL 7035

**Heads** Technopolymer PC+PBT

**Optics** Diffusing, anti-glare aluminium

**Screen** High-transmission micro-prismatic tempered glass (3mm)

**Compliance** EN 60598-1, EN 60598-2-22, EN 1838, UNI 11222, ATEX 2014/34/EU (classification: II 3 G Ex nA II B T135, II 3 D Ex tD A22 T85)

\* LG230, LG24, HT systems consider the parameters of the control unit used

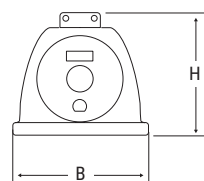

Dimensions mm

L	B	H
464	108	98.5

## Performance according to EN 1838

Height (m)	Centre distance (m) ESCAPE ROUTES		Illuminated surface area (m) LARGE AREAS	
	Wall	Ceiling	Wall	Ceiling
3	-	10	-	8x8
7	-	15	-	14x14
Lighting >1lx at floor level along the centre line without reflections Emax/Emin <40			Lighting >0.5lx at floor level without reflections Emax/Emin <40	
Performance with reference to luminaire Order Code 15030 400 lm			Maintenance coefficient 0.8	

## EMERGENCY STEEL

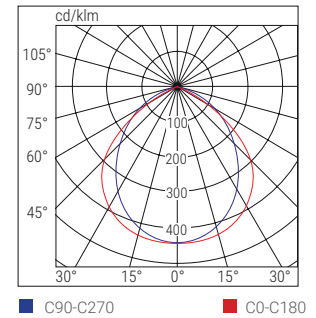

### LOW TEMPERATURE INSTALLATION WITH ICE PACK - only for Order Code 15030



Accessory to keep the battery warm even when operating in very low temperatures (down to -40°C). Ice Pack is controlled by an electronic circuit that maintains a constant battery temperature.

	Order Code	W eq.	Description	Version	Autonomy h	Battery	FLUX SE lm	FLUX SA lm	Input power		Weight Kg	Packaging Single/Multi pack	Conform.
									DC	AC			
LG	15030	24	ACC EM LED 24 LG SE/SA 123H	SA/SE	1/2/3	NiMh 7.2V 1.2Ah	400/275/200	220		4W	1.6	1	CENTRALTEST
	15032	24	ACC EM LED 24 LG SE GL	SE	0.75/1/2/3/8	LiFe 12.8V 1.5A	1800/1500/800/500/200			4W	1.6	1	
	LGM Standalone luminaires with Centralised Radio Diagnostics integrating the Module Order Code 19375												
LG230	31053	24	STEEL LED SE/SA LGS230 GL	SA/SE				1800	14.8W	19.6VA	1.5	1	CENTRALISED BATTERY
	31054	24	STEEL LED SE/SA LGS230	SA/SE				510	4.7W	9.4VA	1.5	1	
LG24	32055	24	STEEL LED SA LGS24	SA/SE			510	510	4.3W		1.5	1	CENTRALISED BATTERY
	32092	24	STEEL LED SE LGS24 GL	SE			900/1800		8/16W		1.5	1	
HT230	17452	24	STEEL AND LED HT GL	SA/SE				1800	14.2W	17.4VA	1.5	1	

\* The indicated battery life doubles with the Autoripara battery, if the luminaire is set to LONG OPERATING TIME

## ACCESSORIES - included

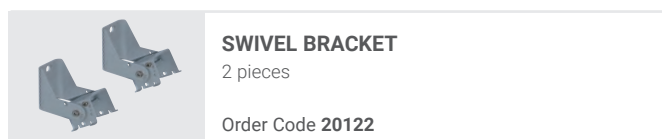

## ACCESSORIES - to be ordered separately

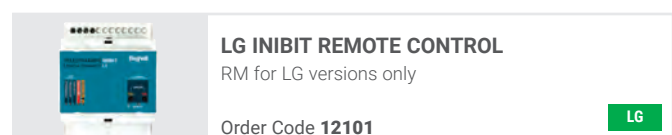
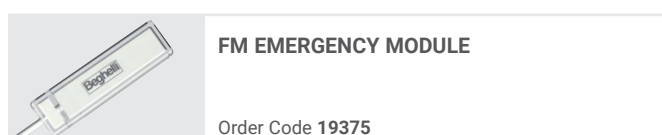
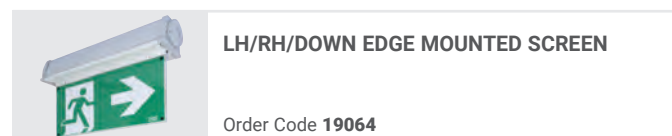
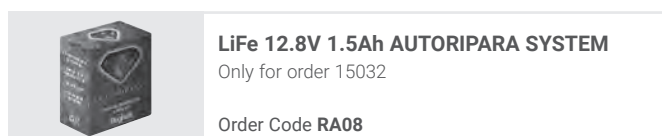
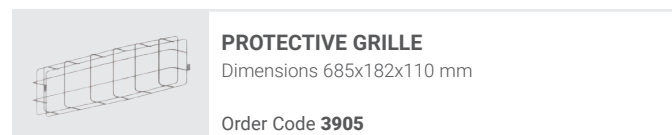
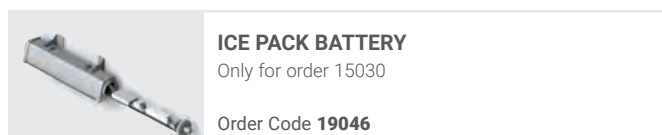



# Lungalargaluce Extreme

emergency



Luminous flux up to 3200lm, suitable for high risk environments where Atex compliance is required. Fast-charging Titanium battery, with 10 years of service life and for extreme working temperatures.



A single luminaire for lighting large areas, escape routes and halls from 2m to over 7m high.



Five easily interchangeable lenses supplied.



Ready for through-wiring.

## Applications

Industrial, in high-risk environments with dust and explosive substances.

## Characteristics

**Power supply\*** 230VAC  $\pm$  10%, 50÷60Hz

**Mounting** Wall, ceiling, recessed

**Recharging time** 12h

**Housing** Die-cast aluminium, RAL 7040

**Optics** Clear polycarbonate lenses

**Compliance** EN 60598-1, EN 60598-2-2, EN 60598-2-22, EN 1838, UNI 11222, ATEX 2014/34/EU (classification: II 3 G Ex nA II B T135, II 3 D Ex tD A22 T85

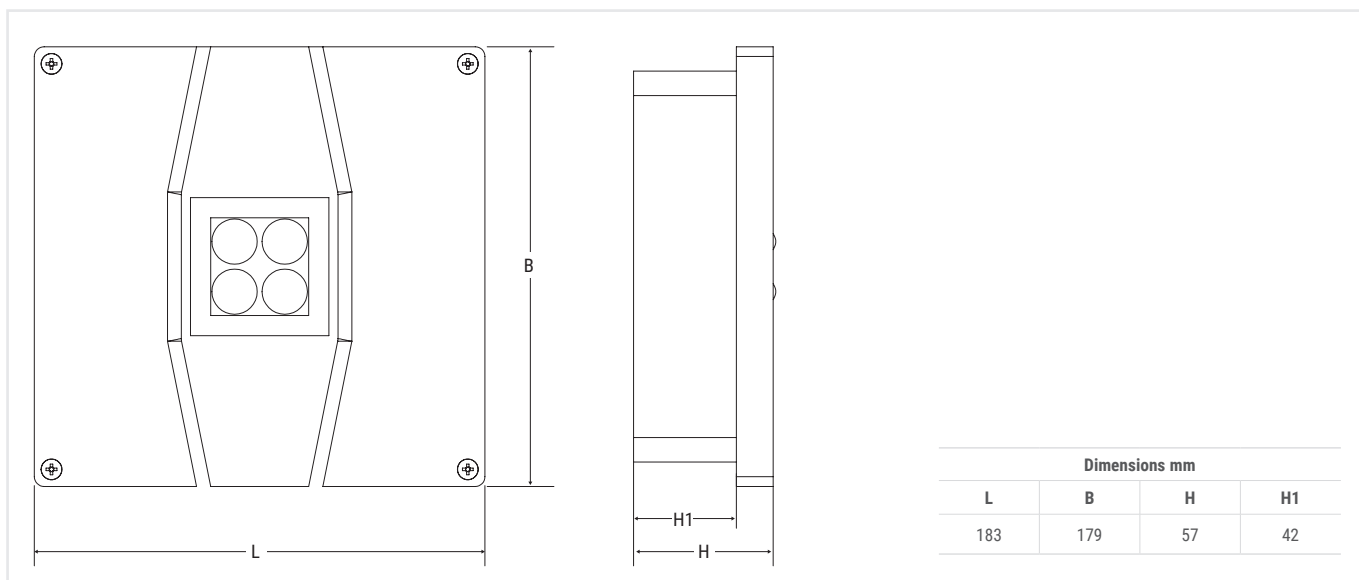

\* LG230, LG24, HT systems consider the parameters of the control unit used



Dimensions mm			
L	B	H	H1
183	179	57	42

064

## Reference standard UNI EN 1838

Lens	Height (m) 	Centre distance (m) ESCAPE ROUTES 		Illuminated surface area (m) LARGE AREAS 	
		Wall	Ceiling	Wall	Ceiling
Lungaluce 3m	3	-	15	-	-
Lungaluce 7m	7	-	22	-	-
Largaluce 3m	3	-	-	-	12x12
Largaluce 7m	7	-	-	-	13x13
High risk	7	-	-	-	Ø 3m - 30lx
			Lighting >1lx at floor level along the centre line without reflections Emax/Emin <40		Lighting >0.5lx at floor level without reflections Emax/Emin <40

Performance with reference to luminaire **Order Code 19379** 1000lm Maintenance coefficient 0.8

HIGH RISK

89%

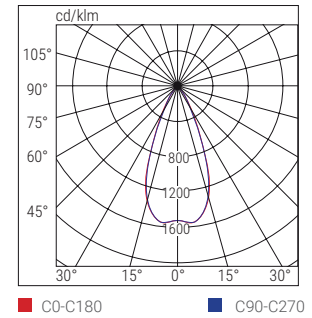

LUNGALUCE 3m 88%

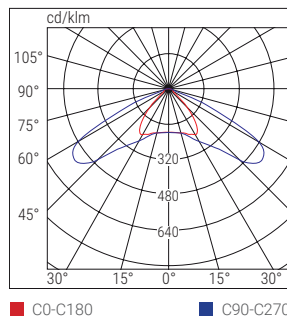

LUNGALUCE 7m 82%

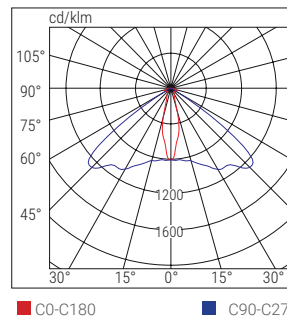

LARGALUCE 3m 92%

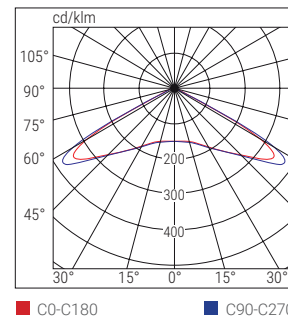

LARGALUCE 7m 89%

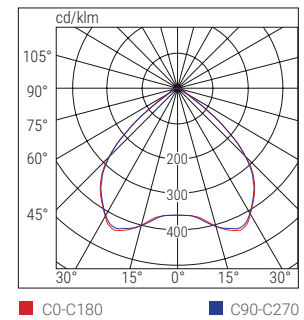

	Order Code	W eq.	Description	Version	Autonomy h	Battery	Flux* SE lm	Flux* SA lm	Input power		Weight Kg	Packaging Single/ Multi pack	
									DC	AC			
AT	19378	24GL	LUNGALARGA EXT GL AT SE	SE	1-1.5-3-8	LiFe 12.8V 3Ah	3200/2500/1400/500		6.5W		0.9	1/6	AUTOTEST
AT-OPT	19370	24	LUNGALARGA EXTREME OPT SA/SE	SA/SE	1-1.5-2-3-8	2xLTO 4.8V 1.2Ah	1155/770/575/385/144	575	7.5W		0.9	1/6	CENTRALISED SELF-TESTING
	LG	Standalone luminaires with Centralised Diagnostics integrating the Module Order No. 15036											
	LGFM	Standalone luminaires with Centralised Radio Diagnostics integrating the Module Order Code 15037											
	DALI	Standalone luminaires with Dali Centralised Diagnostics integrating the Module Order Code 15038											
LG230	31112	24	LUNGALARGA EXTREME LGS230 LS-UV					1400	11.2W	24.1VA	0.9	1/6	CENTRALISED BATTERY
LG24	32083	24	LUNGALARGA EXTREME LGS24 LS-UV				1100	1400	7.4W	22.2VA	0.9	1/6	
HT230	31113	24	LUNGALARGA EXTREME HT					1400	10.7W	22.2VA	0.9	1/6	

\* The fluxes shown in the table refer to the luminaire without lens. To identify the actual flux of the product, please consider the yield of the chosen lens in addition to the value shown in the table.

NEXT >

# Lungalargaluce Extreme

emergency

## ACCESSORIES - included

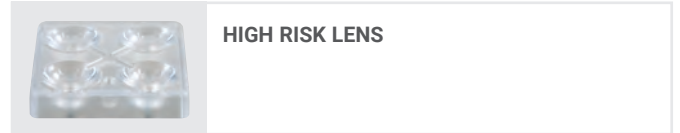
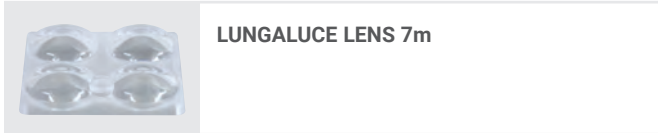
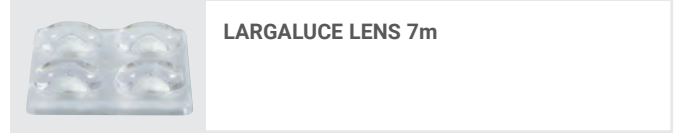
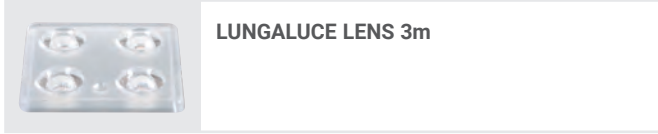

## ACCESSORIES - to be ordered separately

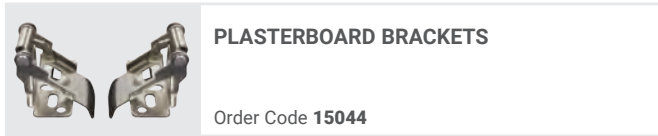
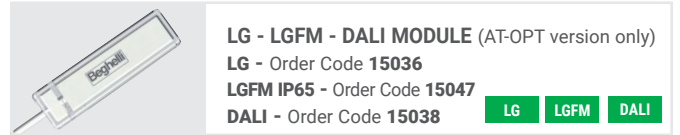
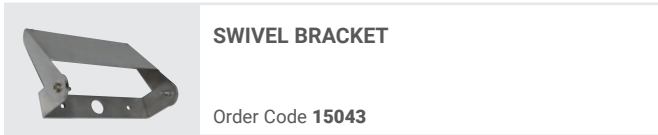





# Stile In SanificaAria

emergency



Hybrid device with uvOxy® air sanitization. Activation regulation by switch in 3 steps: 8, 12, 24 h/day, at a constant sanitization rate. Recessed device with an autonomy of up to 8 hours.

## Applications

Service sector, hospitals, commercial activities, shops, restaurants, offices, schools

## Emergency features

**Power supply unit** 230VAC ± 10%, 50÷60Hz

**Mounting** Wall mounting, ceiling mounting, recessed mounting, false ceiling mounting

**Recharging time** 12h

**Body** Polycarbonate, white RAL 9003

**Optics** PMMA anti-glare diffuser

**Screen** Clear polycarbonate

**Compliance** EN60598-1, EN60598-2-2, EN60598-2-22, EN60335-2-65, ISO 15714, 2014/30/EU, 2014/35/EU

## Specifications of the Air Sanitizer

**Power supply unit** 230VAC ±10%, 50÷60Hz

**Input power uvOxy®** 10 W

**UV-C wavelength** 254 nm

**Sanitization flow rate** 4 m³/h

**UV-C power** 7 W

**UV-C radiation power** 2.4 W

**Sanitization speed** Single

**Timing** 8-12-24 h

**Cartridge life** 12 months

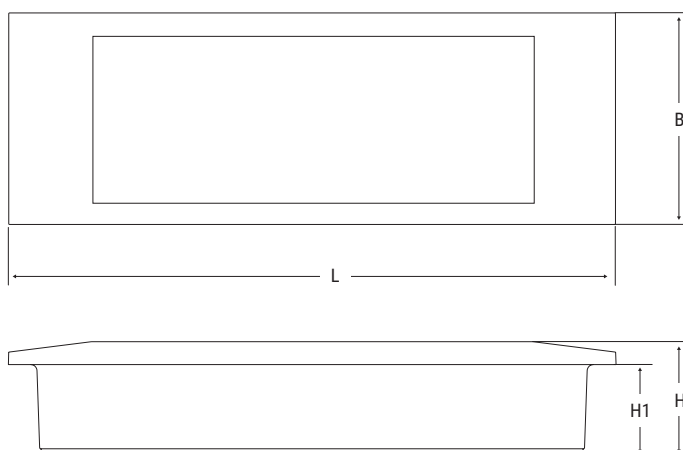

## EXAMPLE OF SANITIZATION OF AIR IN AN ENVIRONMENT

Room size		
Volume m³	Surface area m²	Initial sanitization time h
11	4	2.5
21	8	5
33	12.5	8
44	16.5	11
67	25	17

Dimensions mm				Distance of visibility (DV)	
L	B	H	H1	screen	edge mounting
295	102	55	44	15m	20m



## Performance according to EN 1838 and initial sanitisation time

STANDARD UNI EN 1838	Height (m)	Centre distance (m) ESCAPE ROUTES		Illuminated surface area (m) LARGE AREAS	
		Wall	Ceiling	Wall	Ceiling
	2.5	5	-	3x3	-
3	-	7	-	5x5	
		>1lx without reflections Emax/Emin <40		>0.5lx along the centre line without reflections Emax/Emin <40	
	Flow rate up to 4 m³/h	Initial sanitisation time 5h	Initial sanitisation time 6h		

Performance based on the 1499LUV 120lm wall-mounted model

## STILE IN SanificaAria

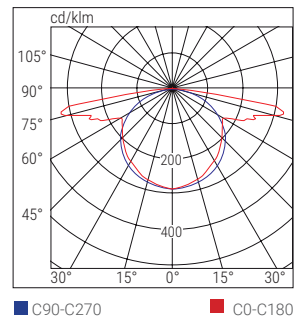

TR	Order Code	W eq.	Description	Version	Autonomy h	Battery	FLUX SE lm	FLUX SA lm	Sanitisation flow rate m³/h			Input power W	Weight Kg	Packaging Single/Multi pack	STANDARD	
									1	2	3					
	1499LUV	8	STILE IN LED SE TR UVOXY	SE	8	LiFe 3.2V 1.5Ah	120	-	4	-	-	2.1	10	0.7	1/12	

## ACCESSORIES - included



**RECESSED BOX**

Order Code **3733**

## ACCESSORIES AND SPARE PARTS - to be ordered separately

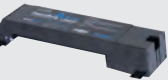

**SPARE PART**  
**uvOxy® STILE IN PURIFICATION CARTRIDGE**

Duration 12 months, at a continuous use 24h/day

Order Code **26724**



**FALSE CEILING BRACKETS**

Recessed mounting hole: 279x94 mm

Order Code **4266**



**LH/RH/DOWN SCREENS**

Screen printing on opal polycarbonate

Order Code **4269**

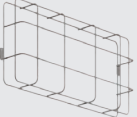

**PROTECTIVE GRILLE**

Dimensions: 440x215x99 mm

Order Code **3912**



**LH/RH/DOWN STICKERS**

Order Code **4278**

# Pratica SanificaAria

emergency



- IP20
- IK08
- 85°
- Batt. LiFe
- +40°C  
0°C
- 8-12-24h
- 1

Hybrid device with uvOxy® air sanitization. Activation regulation by switch in 3 steps: 8, 12, 24 h/day, at a constant sanitization rate. Highly robust body with LiFe battery. Presence of the test button.

## Applications

Industry, service sector

## Emergency features

**Power supply unit** 230VAC ± 10%, 50÷60Hz

**Mounting** Wall mounting, ceiling mounting, suspended mounting, edge mounting, electrified track mounting

**Recharging time** 12h

**Body** ABS, white RAL 9003

**Optics** PMMA anti-glare diffuser

**Screen** Clear polycarbonate

**Conformity** EN60598-1; EN60598-2-22, EN60335-2-65, ISO 15714, 2014/30/EU, 2014/35/EU

## Specifications of the Air Sanitizer

**Power supply unit** 230VAC ±10%, 50÷60Hz

**Input power uvOxy®** 10 W

**UV-C wavelength** 254 nm

**Sanitization flow rate** 5 m³/h

**UV-C power** 7 W

**UV-C radiation power** 2.5 W

**Sanitization speed** Single

**Timing** 8-12-24 h

**Cartridge life** 12 months

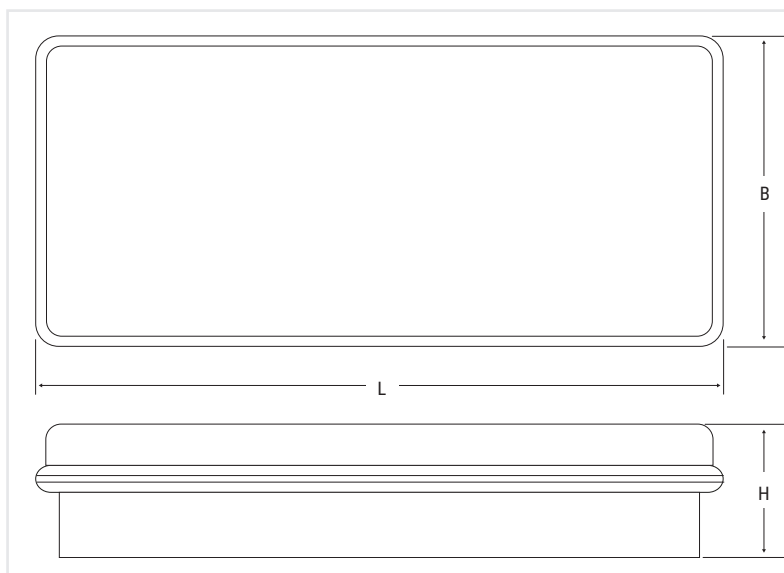

## EXAMPLE OF SANITIZATION OF AIR IN AN ENVIRONMENT

Room size		
Volume m³	Surface area m²	Initial sanitization time h
11	4	2
27	10	5
54	20	10
81	30	16
108	40	21

Dimensions mm			Distance of visibility (DV)
L	B	H	
300	138	55	25 m

070

## Performance according to EN 1838 and initial sanitisation time

STANDARD UNI EN 1838	Height (m)	Centre distance (m) ESCAPE ROUTES		Illuminated surface area (m) LARGE AREAS	
		Wall	Ceiling	Wall	Ceiling
	2.5	8	-	4x6	-
3	-	9	-	6x7	
		>1lx without reflections Emax/Emin <40		>0.5lx along the centre line without reflections Emax/Emin <40	

	Flow rate up to 5 m³/h	Initial sanitisation time 6h	Initial sanitisation time 12h
--	------------------------	------------------------------	-------------------------------

## PRATICA SanificaAria

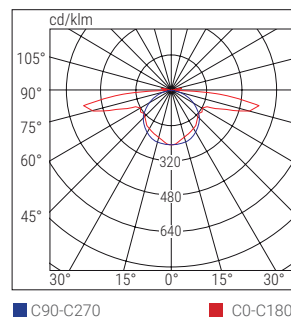

Performance based on the 250SEUV 250lm wall-mounted model

	Order Code	W eq.	Description	Version	Autonomy h	Battery	FLUX SE lm	FLUX SA lm	Sanitisation flow rate m³/h			Input power W	Weight Kg	Packaging Single/Multi pack	
									1	2	3				
TR	250SEUV	18	PRATICA 300LM 1.5/3h SE TR UVOXY	SE	1.5/3	LiFe 3.2V 1.5Ah	300/160	-	5	-	-	4	10	0.8	1/12
	250SAUV	18	PRATICA 300LM 1.5/3h SA TR UVOXY	SA/SE	1.5/3	LiFe 3.2V 1.5Ah	300/160	200	5	-	-	4	10	0.8	1/12
	500SEUV	24	PRATICA 500LM 1.5/3h SE TR UVOXY	SE	1.5/3	LiFe 3.2V 3Ah	500/250	-	5	-	-	4	10	0.9	1/12
	500SAUV	24	PRATICA 500LM 1.5/3h SA TR UVOXY	SA/SE	1.5/3	LiFe 3.2V 3Ah	500/250	200	5	-	-	4	10	0.9	1/12
AT	250ATSEUV	18	PRATICA 300LM 1.5/3h SE AT UVOXY	SE	1.5/3	LiFe 3.2V 1.5Ah	300/160	-	5	-	-	4	10	0.8	1/12
	250ATSAUV	18	PRATICA 300LM 1.5/3h SA AT UVOXY	SA/SE	1.5/3	LiFe 3.2V 1.5Ah	300/160	200	5	-	-	4	10	0.8	1/12
	500ATSEUV	24	PRATICA 500LM 1.5/3h SE AT UVOXY	SE	1.5/3	LiFe 3.2V 3Ah	500/250	-	5	-	-	4	10	0.9	1/12
	500ATSAUV	24	PRATICA 500LM 1.5/3h SA AT UVOXY	SA/SE	1.5/3	LiFe 3.2V 3Ah	500/250	200	5	-	-	4	10	0.9	1/12

## ACCESSORIES - included

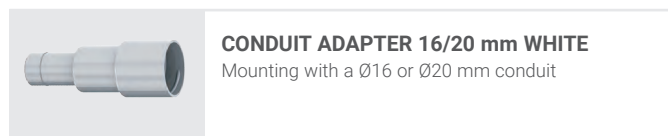

## ACCESSORIES AND SPARE PARTS - to be ordered separately

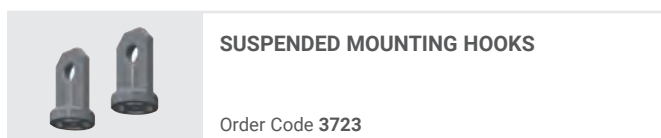
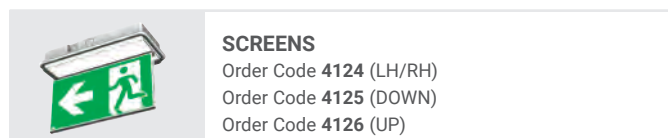
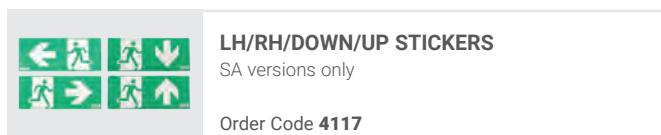
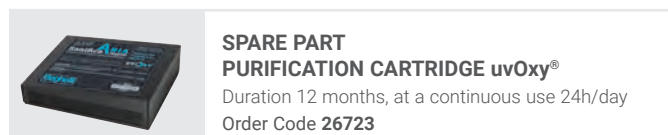

# Formula 65 SanificaAria

emergency



Batt. LTO

IP20 IK07 850°

+45°C -20°C

8-12-24h

1 2 3

Hybrid device with uvOxy® air sanitization. Activation adjustable in 3 steps: 8, 12, 24 h/day and at 3 sanitizing speeds. Parameter adjustment from APP B.connect.

Adjustable autonomy in AT version. High luminous flux of up to 1200lm.

## Applications

Industry, service sector, hospitals, commercial activities, shops, restaurants, offices, schools

## Emergency features

**Power supply unit\*** 230VAC±10%, 50÷60Hz

**Mounting** Wall mounting, ceiling mounting

**Recharging time** 12h

**Body** ABS, white RAL 9003

**Optics** Symmetrical, white

**Screen** Clear polycarbonate

**Compliance** EN60598-1, EN60598-2-22, EN60335-2-65, ISO 15714, 2014/30/EU, 2014/35/EU

## Specifications of the Air Sanitizer

**Power supply unit** 230VAC ±10%, 50÷60Hz

**Input power uvOxy®** 10 W

**UV-C wavelength** 254 nm

**Sanitization flow rate** 8 m³/h

**UV-C power** 7 W

**UV-C radiation power** 2.4 W

**Sanitization speed** 1-2-3 steps

**Timing** 8-12-24h

**Cartridge life** 12 months

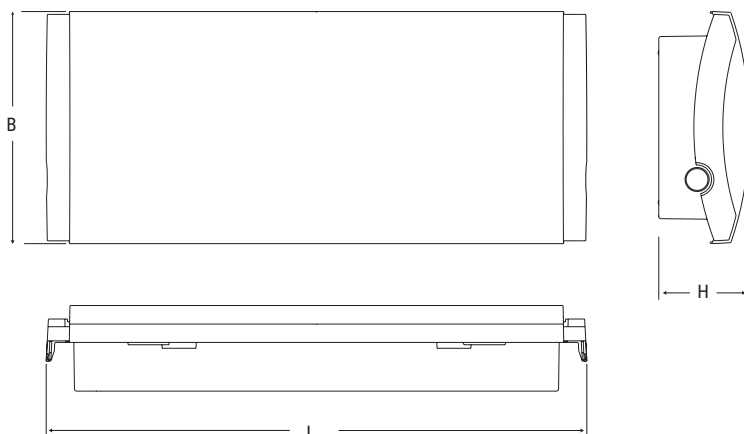

## EXAMPLE OF SANITIZATION OF AIR IN AN ENVIRONMENT

Room size		
Volume m³	Surface area m²	Initial sanitization time h
22	8	2.5
43	16	5
86	32	10
135	50	17
202	75	25

Dimensions mm			Distance of visibility (DV)	
L	B	H	Wall	Edge mounting
354	152	63.4	25 m	28 m

## Performance according to EN 1838 and initial sanitisation time

## FORMULA65 SanificaAria

STANDARD UNI EN 1838	Height (m)	Centre distance (m) ESCAPE ROUTES		Illuminated surface area (m) LARGE AREAS	
		Wall	Ceiling	Wall	Ceiling
	2.5	11	-	8x12	-
3	-	18	-	10x16	
	>1lx without reflections Emax/Emin <40		>0.5lx along the centre line without reflections Emax/Emin <40		

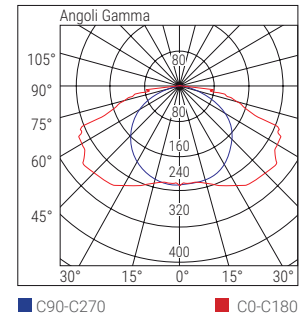

Performance based on the 19430UV 1100lm wall-mounted model - Sanitisation flow rate 3

	Order Code	W eq.	Description	Version	Autonomy h	Battery	FLUX SE lm	FLUX SA lm	Sanitisation flow rate m³/h			Input power W	Weight Kg	Packaging Single/Multi pack	
									1	2	3				
TR	19430UV	36	F65 LED LTO SE UVOXY	SE	1.5	2x LTO 4.8V 1.2Ah	1100	-	2.5	5	8	2	10	1.1	1/6
	19431UV	36	F65 LED LTO SA UVOXY	SA/SE	1.5	2x LTO 4.8V 1.2Ah	1100	350	2.5	5	8	5	10	1.1	1/6
AT	19432UV	36	F65 LED LTO AT SE UVOXY	SE	1/3	2x LTO 4.8V 1.2Ah	1200/450	-	2.5	5	8	2	10	1.1	1/6
	19433UV	36	F65 LED LTO AT SA UVOXY	SA/SE	1/3	2x LTO 4.8V 1.2Ah	1200/450	350	2.5	5	8	5	10	1.1	1/6

## ACCESSORIES - included

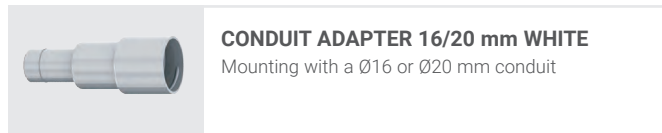
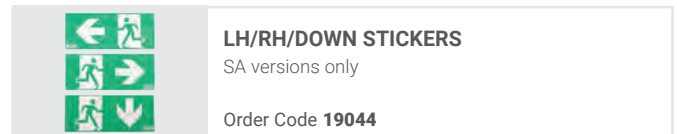
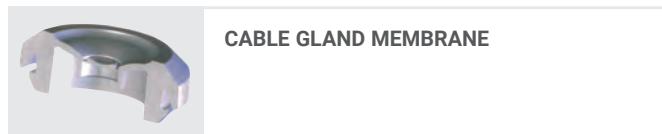

## ACCESSORIES AND SPARE PARTS - to be ordered separately

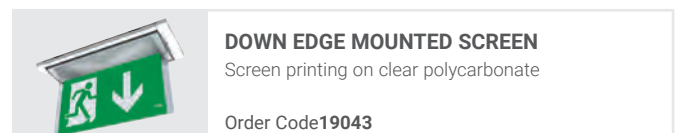
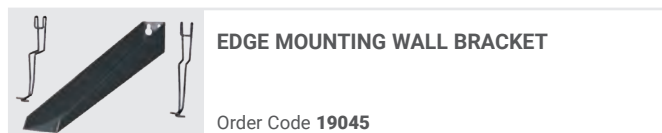
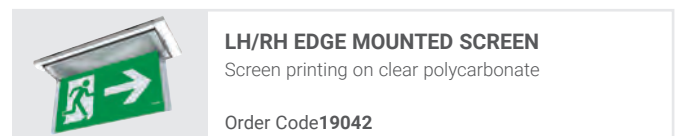
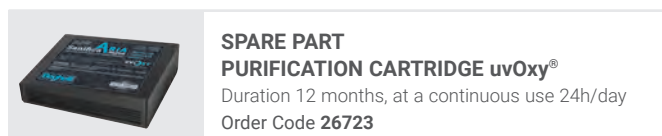



# Infinita SanificaAria

emergency



IP20
IK08
85°
Batt. LTO
+45°C / -20°C
8-12-24h
1
2
3

Hybrid device with uvOxy® air sanitization. Activation adjustable in 3 steps: 8, 12, 24 h/day and at 3 sanitizing speeds. Parameter adjustment from B.connect APP and NuBe. Luminous flux up to 1000lm, infinite autonomy, with Infinity mode and Titanium battery.

## Applications

Industry, service sector, hospitals, commercial activities, shops, restaurants, offices, schools

## Emergency features

**Power supply unit\*** 230VAC ± 10%, 50÷60Hz

**Mounting** Wall mounting, ceiling mounting, wall/ceiling edge mounting, suspended mounting

**Recharging time** 12h

**Body** ABS white RAL 9003

**Optics** Total Internal Reflection

**Screen** Clear polycarbonate

**Compliance** EN60598-1, EN60598-2-2, EN60598-2-22, EN60335-2-65, ISO 15714, 2014/53/EU

## Specifications of the Air Sanitizer

**Power supply unit** 230VAC ± 10%, 50÷60Hz

**Input power uvOxy®** 10 W

**UV-C wavelength** 254 nm

**Sanitization flow rate** 8 m³/h

**UV-C power** 7 W

**UV-C radiation power** 2.4 W

**Sanitization speed** 1-2-3 steps

**Timing** 8-12-24 h

**Cartridge life** 12 months

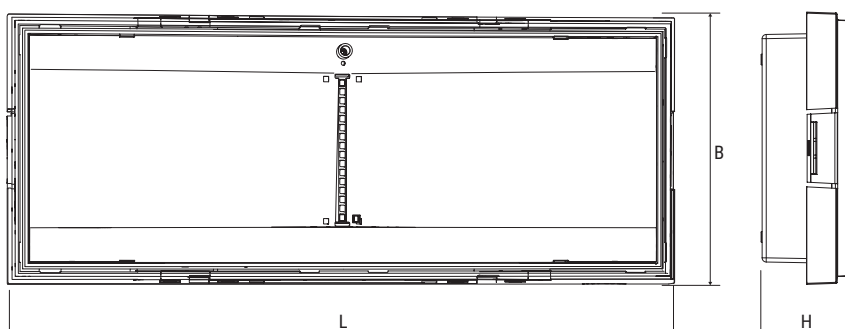

## EXAMPLE OF SANITIZATION OF AIR IN AN ENVIRONMENT

Room size		
Volume m³	Surface area m²	Initial sanitization time h
22	8	2.5
43	16	5
86	32	10
135	50	17
202	75	25

Dimensions mm			Distance of visibility (DV)
L	B	H	
325	130	45	25 m

## Performance according to EN 1838 and initial sanitisation time

INFINITA SanificaAria

STANDARD UNI EN 1838	Height (m)	Centre distance (m) ESCAPE ROUTES		Illuminated surface area (m) LARGE AREAS		
		Wall	Ceiling	Wall	Ceiling	
	2.5	8	-	6x8	-	
	3	-	10	-	9x10	
	>1lx without reflections Emax/Emin <40		>0.5lx along the centre line without reflections Emax/Emin <40			

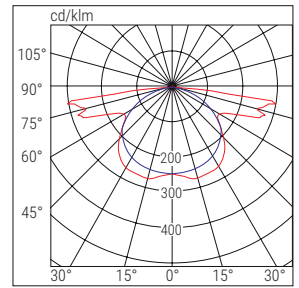

	Flow rate up to 8 m³/h	Initial sanitisation time 4h	Initial sanitisation time 15h
--	------------------------	------------------------------	-------------------------------

Performance based on the 19451UV 500lm wall-mounted model - Sanitisation flow rate 3

	Order Code	W eq.	Description	Vers.	Autonomy h	Battery	FLUX SE lm	FLUX SA lm	Sanitisation flow rate m³/h			Input power W	Weight Kg	Packaging Single/Multi pack	
									1	2	3				
AT-CBL	19450UV	11	INFINITA RTI SE CBL LTO L UVOXY	SE	1/1.5/ 2/3/8	LTO 4.8V 1.2Ah	250/170/130/90/40	-	2.5	5	8	1	10	0.9	1/6
	19451UV	24	INFINITA RTI SE CBL LTO XL UVOXY	SE	1/1.5/2/3/8	LTO 4.8V 1.2Ah	500/340/260/180/70	-	2.5	5	8	2.6	10	0.9	1/6
	19452UV	11	INFINITA RTI SA CBL LTO L UVOXY	SA/SE	1/1.5/2/3/8	LTO 4.8V 1.2Ah	250/170/130/90/40	90	2.5	5	8	1.8	10	0.9	1/6
	19453UV	24	INFINITA RTI SA CBL LTO XL UVOXY	SA/SE	1/1.5/2/3/8	LTO 4.8V 1.2Ah	500/340/260/180/70	250	2.5	5	8	4.8	10	0.9	1/6
	19460UV	24GL	INFINITA GL RTI SA/SE CBL LTO UVOXY	SA/SE	1/1.5/2/3/8	2x LTO 4.8V 1.2Ah	1000/680/525/370/145	250	2.5	5	8	1.8	10	0.9	1/6
	<b>LG</b>	Standalone luminaires with Centralised Diagnostics integrating the Module Order No. 15036													
	<b>LGFM</b>	Standalone luminaires with Centralised Radio Diagnostics integrating the Module Order Code 15037													
	<b>DALI</b>	Standalone luminaires with Dali Centralised Diagnostics integrating the Module Order Code 15038													

## ACCESSORIES - included

	<b>CABLE GLAND MEMBRANE</b>		<b>LH/RH/DOWN/UP STICKERS</b> (included for SA versions only)  Order Code <b>4682</b>
	<b>CONDUIT ADAPTER 16/20 mm WHITE</b> Mounting with a Ø16 or Ø20 mm conduit		

## ACCESSORIES AND SPARE PARTS - to be ordered separately

	<b>SPARE PART PURIFICATION CARTRIDGE uvOxy®</b> Duration 12 months, at a continuous use 24h/day Order Code <b>26723</b>		<b>45° BRACKET</b>  Order Code <b>4685</b>
	<b>EDGE MOUNTED SCREEN</b>  Order Code <b>4681</b>		<b>SUSPENDED MOUNTING RODS</b> 250 - 500 - 1000 mm Order Code <b>4315</b> (250 mm) - <b>4316</b> (500 mm) <b>4317</b> (1000 mm)
	<b>EDGE MOUNTING FIXING BRACKET</b>  Order Code <b>4686</b>		<b>LG - LGFM - DALI MODULE</b> LG - Order Code <b>15036</b> LGFM - Order Code <b>15037</b> DALI - Order Code <b>15038</b>
	<b>SUSPENDED MOUNTING HOOKS</b>  Order Code <b>3723</b>		<b>CABLECOM CONNECT CBL CONTROL UNIT</b>  Order Code <b>20151</b>

# Nu.da

emergency



**archieco** : clean and elegant design lines with surfaces that can be painted together with the wall.

Small size compared to high luminous flux.

Monolithic screen made of shaped methacrylate, designed specifically to optimise light diffusion and to accommodate the pictogram, where required, with an excellent level of light uniformity.

## Applications

Services and residential, even in design situations where special care is required to reduce the aesthetic impact of emergency lighting.

## Characteristics

**Power supply** 230VAC ± 10%, 50÷60Hz

**Mounting** Wall, ceiling

**Recharging time** 12h

**Housing** Polycarbonate, white RAL 9003

**Optics** PMMA

**Compliance** EN 60598-1, EN 60598-2-22, UNI EN 1838, UNI 11222, EN 62034

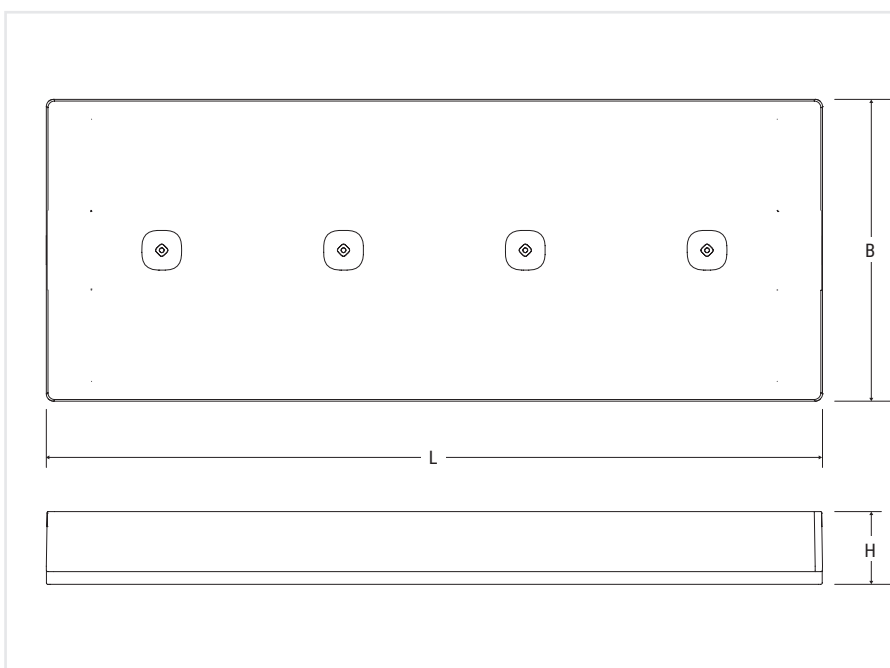

Dimensions mm			Distance of visibility (DV)
L	B	H	
213	83	20	16m

076

## Performance according to EN 1838

Height (m)	Centre distance (m) ESCAPE ROUTES		Illuminated surface area (m) LARGE AREAS	
	Wall	Ceiling	Wall	Ceiling
2.5	7	-	5x6	-
3	-	10	-	7x7
Lighting >1lx at floor level along the centre line without reflections Emax/Emin <40			Lighting >0.5lx at floor level without reflections Emax/Emin <40	
Performance with reference to luminaire Order Code 19601 250 lm			Maintenance coefficient 0.8	

## NU.DA

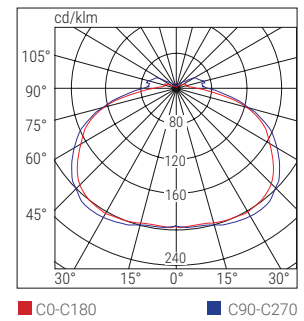

	Order Code	W eq.	Description	Version	Autonomy h	Battery	FLUX SE lm	FLUX SA lm	Input power		Weight Kg	Packaging Single/Multi pack
									DC	AC		
TR	19600		NU.DA SE 1/2H LiFe	SE	1/2	LiFe 3.2V 0.5Ah	150/100			1W	0.2	1/12
	19601		NU.DA SE 1.5/3H LiFe	SE	1.5/3	LiFe 3.2V 1.5Ah	250/130			1.3W	0.25	1/12
	19602		NU.DA SE/SA 1/2H LiFe	SA/SE	1/2	LiFe 3.2V 0.5Ah	150/100	100		1.6W	0.2	1/12
	19603		NU.DA SE/SA 1.5/3H LiFe	SA/SE	1.5/3	LiFe 3.2V 1.5Ah	250/130	170		2.5W	0.25	1/12
AT-CBL	19620	11-24	NU.DA 1124W AT CBL SE 8LTO	SE	1/1.5/2/3/8	LTO 4.8V 0.5Ah	250/170/130/85/35			1.7W	0.2	1/12
	19621	24-36	NU.DA 2436W AT CBL SE 8LTO	SE	1/1.5/2/3/8	LTO 4.8V 1Ah	450/305/230/155/65			1.7W	0.25	1/12
	19622	11-24	NU.DA 1124W AT CBL SE/SA 8LTO	SA/SE	1/1.5/2/3/8	LTO 4.8V 0.5Ah	250/170/130/85/35	170		3W	0.2	1/12
	19623	24-36	NU.DA 2436W AT CBL SE/SA 8LTO	SA/SE	1/1.5/2/3/8	LTO 4.8V 1Ah	450/305/230/155/65	170		3W	0.25	1/12
	LG	Standalone luminaires with Centralised Diagnostics integrating the Module Order No. 15036										
	LGFM	Standalone luminaires with Centralised Radio Diagnostics integrating the Module Order Code 15037										
	DALI	Standalone luminaires with Dali Centralised Diagnostics integrating the Module Order Code 15038										

## ACCESSORIES - to be ordered separately



**LG - LGFM - DALI MODULE**  
 LG - Order Code 15036  
 LGFM - Order Code 15037  
 DALI - Order Code 15038

LG

LGFM

DALI



**LH/RH/DOWN/UP STICKERS**

Order Code 4329



**THREE-PHASE TRACK KIT**

Order Code 4319

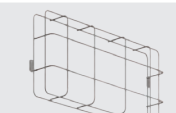

**PROTECTIVE GRILLE**  
 Dimensions: 305x110x100 mm

Order Code 3903



# Design

emergency



IP40

IK05

850°



Batt. NiMH

+40°C  
0°C



**archieco** : clean and elegant design lines with surfaces that can be painted together with the wall, made of recyclable and partly compostable materials.



Suitable for both ceiling and wall mounting.



The optical scheme is realised by a double reflection system to obtain an intense and diffusing beam with a soft effect.

## Applications

Services and residential, even in design situations where special care is required to reduce the aesthetic impact of emergency lighting.

## Characteristics

**Power supply** 230VAC  $\pm$  10%, 50÷60Hz

**Mounting** Wall, ceiling, recessed, edge mounting

**Housing** PHA white RAL 9003

**Optics** Symmetrical, white

**Screen** Clear polycarbonate

**Compliance** EN 60598-1, EN 60598-2-2, EN 60598-2-22, UNI EN 1838, UNI 11222, EN 62034

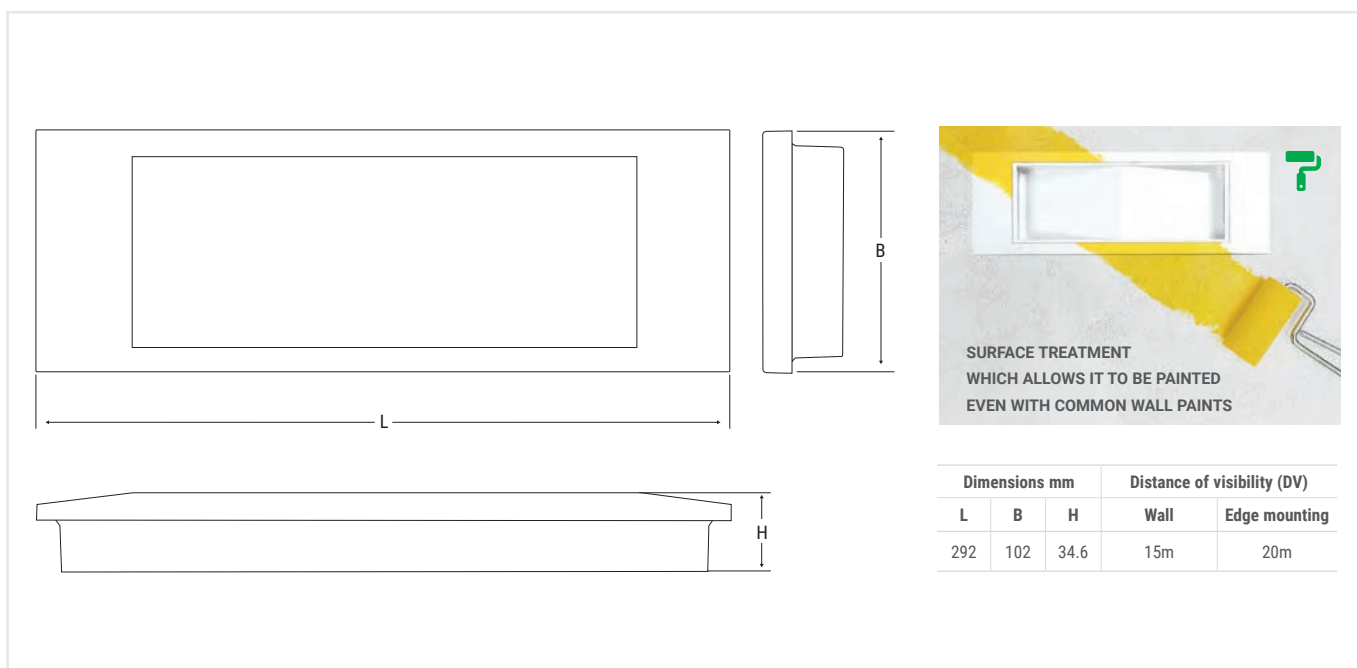

Dimensions mm			Distance of visibility (DV)	
L	B	H	Wall	Edge mounting
292	102	34.6	15m	20m

078



## Performance according to EN 1838

Height (m)	Centre distance (m) ESCAPE ROUTES		Illuminated surface area (m) LARGE AREAS	
	Wall	Ceiling	Wall	Ceiling
2.5	6	-	3x5	-
3	-	11	-	6x6
Lighting >1lx at floor level along the centre line without reflections Emax/Emin <40			Lighting >0.5lx at floor level without reflections Emax/Emin <40	
Performance with reference to luminaire <b>Order Code 4293A</b> 225 lm			Maintenance coefficient 0.8	

## DESIGN

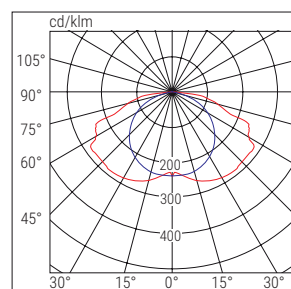

■ C0-C180 ■ C90-C270

	Order Code	W eq.	Description	Version	Autonomy h	Battery	FLUX SE lm	FLUX SA lm	Input power		Weight Kg	Packaging Single/Multi pack
									DC	AC		
TR	4290A	8	DESIGN AE 8W SE 1H IP40	SE	1	NiMH 3.6V 1.2Ah	120	-	1W		0.4	1/12
	4291A	11	DESIGN AE 11W SE 1H IP40	SE	1	NiMH 3.6V 1.2Ah	140	-	1W		0.4	1/12
	4292A	11	DESIGN AE 11W SE/SA 1H IP40	SA/SE	1	NiMH 3.6V 1.2Ah	140	90	2.5W		0.4	1/12
	4293A	24	DESIGN AE 24W SE 1H IP40	SE	1	2 x NiMH 3.6V 1.2Ah	225	-	1W		0.4	1/12

## ACCESSORIES - included

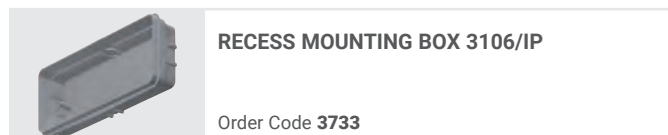

## ACCESSORIES - to be ordered separately

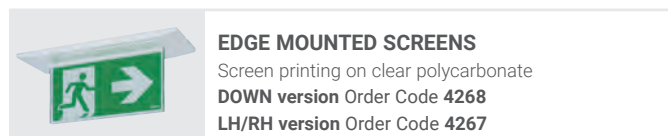
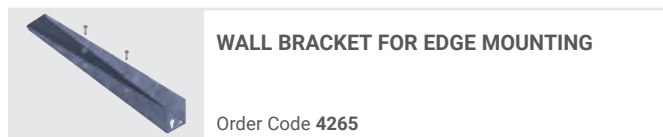
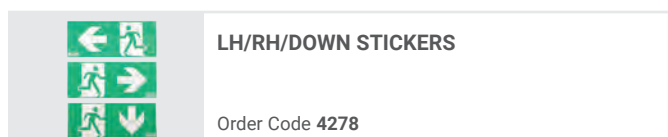
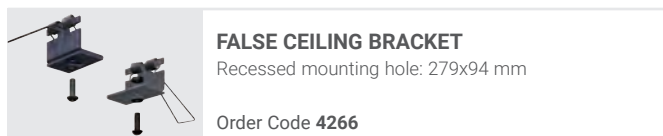
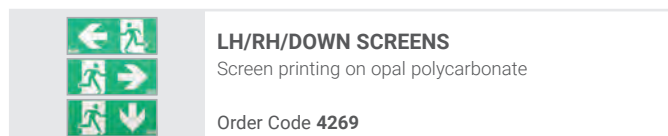

# Dot

emergency



nuBe

- IP65
- IK07
- 850°
- Batt. LiFe  $+40^{\circ}\text{C}$   $0^{\circ}\text{C}$
- Batt. LTO  $+45^{\circ}\text{C}$   $-20^{\circ}\text{C}$
- 



- archieco** : clean and elegant design lines with surfaces that can be painted together with the wall, made of recyclable and partly compostable materials.
- Small dimensions with a luminous flux of up to 1000lm. Possibility to integrate laser signage with an Orma IP65 module.
- By rotating the lens, the luminaire is suitable for both large areas (225m<sup>2</sup>) and escape routes up to 23m.
- Double optical scheme made up of two pairs of lenses rotating on the axis and alternatively matching two high-efficiency LEDs.

## Applications

Services, offices, cinemas, hotels, museums, schools, shops, shopping centres, design rooms

## Characteristics

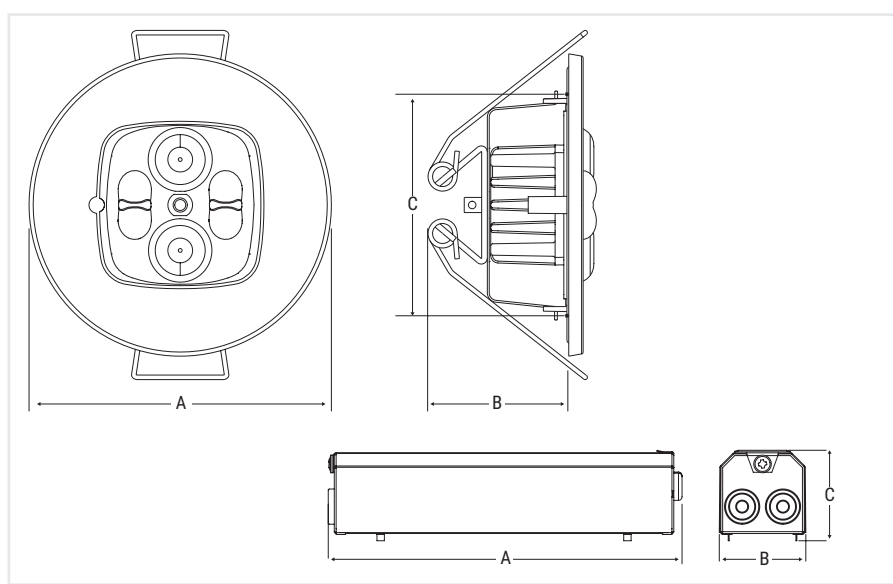

- Power supply** 230VAC  $\pm$  10%, 50÷60Hz
- Mounting** Recessed
- Recharging time** 12h
- Housing** PHA white RAL 9003
- Optics** PMMA
- Compliance** EN 60598-1, EN 60598-2-2, EN 60598-2-22, UNI EN 1838, UNI 11222, EN 62034



**SURFACE TREATMENT**  
WHICH ALLOWS IT TO BE PAINTED  
EVEN WITH COMMON WALL PAINTS

	Dimensions mm		
	A	B	C
Luminaire	Ø 80	38	Ø 59
Inverter versions <b>TR-AT</b>	191	47	49
Inverter version <b>LG</b>	254	47	52

## Performance according to EN 1838

Lens	Height (m) 	Centre distance (m) ESCAPE ROUTES 		Illuminated surface area (m) LARGE AREAS 	
		Wall	Ceiling	Wall	Ceiling
Lungaluce	3	-	30	-	-
Largaluce	3	-	-	-	14x16

Performance with reference to luminaire Order Code 19712 1000lm

Maintenance coefficient 0.8

## LUNGALUCE

80%

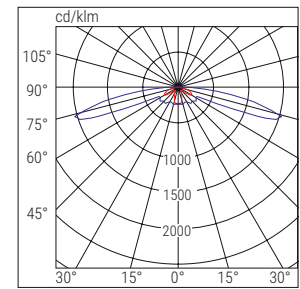

■ C90-C270

■ C0-C180

## ORMA LASER MODULE

Laser micro-projector that emits a bright and prominent arrow-shaped asymmetrical conical beam, producing a virtual pictogram to indicate the nearest escape route. To position the image on the ground at the most suitable point and with the correct signal orientation, simply rotate the body of the device.

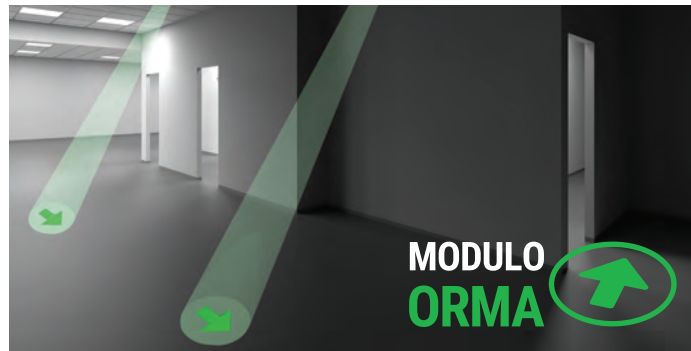

## LARGALUCE

91%

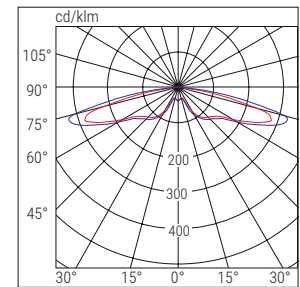

■ C0-C180

■ C90-C270

	Order Code	W	Description	Version	Autonomy h	Battery	FLUX SE lm	FLUX SA lm	Input power		Weight Kg	Packaging Single/ Multi pack	
									DC	AC			
TR	19700		DOT SE/SA 1/2/3H IP65 RM	SA/SE	1/2/3	LiFe 3.2V 1.5Ah	550/300/200	240		3W	0.4	1/6	STANDARD
AT - OPT	19711		DOT AT OPT SE/SA 8LTO IP65	SA/SE	1/1.5/2/3/8	2xLTO 7.2V 0.5AH	550/380/300/200/100	240		5W	0.5	1/6	CENTRALISED SELF-TESTING
	LG		Standalone luminaires with Centralised Diagnostics integrating the Module Order No. 15036										
	LGFM		Standalone luminaires with Centralised Radio Diagnostics integrating the Module Order Code 15037										
	DALI		Standalone luminaires with Dali Centralised Diagnostics integrating the Module Order Code 15038										
LG	19712		DOT GL AT LG SE LIFE IP65	SE	1/2/3	LiFe 12.8V 1.5Ah	1000/550/400	240		4.3W	0.4	1/6	CENTRALISED TEST
	LGFM		Standalone luminaires with Centralised Radio Diagnostics integrating the Module Order Code 19375										
LG230	17880		DOT LGS230 IP65				550		4.7W	9.4VA	0.4	1/6	CENTRALISED BATTERY
LG24	17881		DOT LGS24 IP65				550		4.1W		0.4	1/6	
HT230	17882		DOT HT IP65				550		4.6W	9.1VA	0.4	1/6	

## ACCESSORIES - to be ordered separately



**ORMA LASER MODULE**  
Only for Order Code 19700 and 19711

Order Code **19883**



**LG - LGFM - DALI MODULE** (AT-OPT version only)  
**LGFM** - Order Code **15037** - **19375**  
**LG** - Order Code **15036**  
**DALI** - Order Code **15038**

LG LGFM DALI



**LG INIBIT REMOTE CONTROL**  
RM for LG versions only

Order Code **12101**

LG



**RM INIBIT REMOTE CONTROL**  
RM for TR versions only

Order Code **2730**

RM

# Zero

emergency



**archieco** : clean and elegant design lines with surfaces that can be painted together with the wall, made of recyclable materials.



Revolutionary design with unprecedented aesthetic features.



Emergency luminaire but also safety signage, both single-sided and edge mounted, but also multiple installation solutions.



Three optical solutions to meet any requirement:  
 Mirror Silver symmetrical  
 Mirror Silver asymmetrical  
 Mirror Silver diffusing

## Applications

Residential, services, offices, shops, design showrooms

## Characteristics

**Power supply** 230VAC  $\pm$  10%, 50÷60Hz

**Mounting** Wall, ceiling

**Recharging time** 12h

**Housing** Polyester powder-coated pre-galvanised sheet steel, white RAL 9003

**Optics** Aluminium reflector and PMMA diffuser

**Compliance** EN 60598-1, EN 60598-2-22, UNI EN 1838, UNI 11222, EN 62034

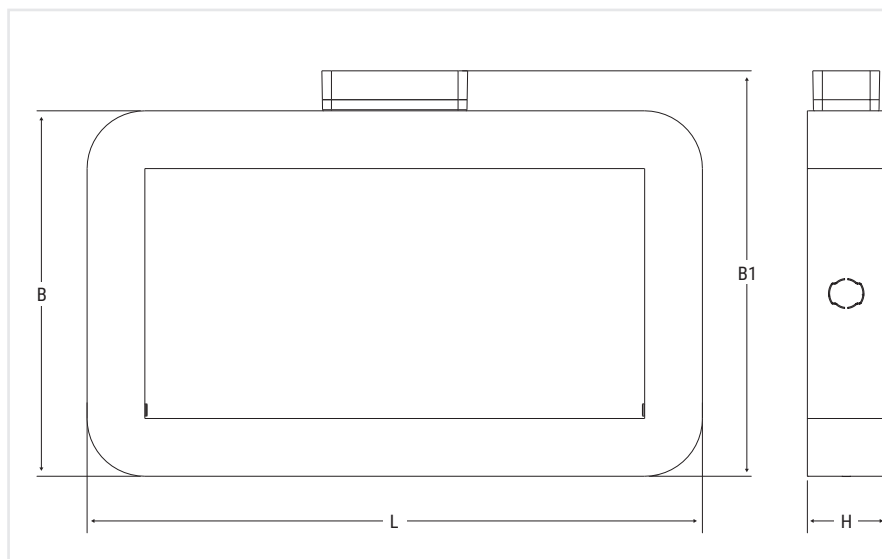

Dimensions mm			
L	B	B1	H
277	164.5	182.5	35

082

	Order Code	W	Description	Version	Autonomy h	Battery	FLUX SE lm	FLUX SA lm	Input power		Weight Kg	Packaging Single/Multi pack
									DC	AC		
TR	18200		ZERO SE/SA TR RM	SA/SE	1/2/3	LiFe 3.2V 1.5Ah	1000	450		3W		STANDARD
AT - OPT	18201		ZERO SE/SA OPT	SA/SE	1/1.5/2/3/8	2xLTO 7.2V 0.5AH	1000	450		5W		CENTRALISED SELF-TESTING
	LG	Standalone luminaires with Centralised Diagnostics integrating the Module Order No. 15036										
	LGFM	Standalone luminaires with Centralised Radio Diagnostics integrating the Module Order Code 15037										
	DALI	Standalone luminaires with Dali Centralised Diagnostics integrating the Module Order Code 15038										
LG230	17902		ZERO LGS230 LS-UV					450	4.1W	8.3VA		CENTRALISED BATTERY
LG24	17903		ZERO LGS24 LS-UV				450	450	3.7W			
HT230	17904		ZERO HT					450	4.7W	9.5VA		

### ONE LUMINAIRE, 4 INSTALLATION SOLUTIONS

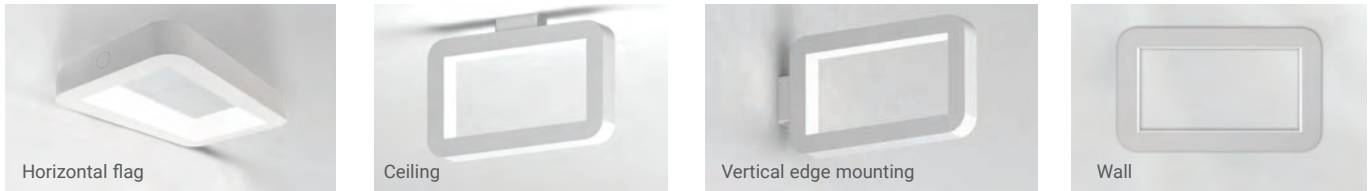

### ACCESSORIES - to be ordered separately



**LG - LGFM - DALI MODULE** (AT-OPT version only)  
**LG** - Order Code **15036**  
**LGFM** - Order Code **15037**  
**DALI** - Order Code **15038**

**LG**   **LGFM**   **DALI**



**RM INIBIT REMOTE CONTROL**  
 RM for TR versions only

Order Code **2730**

**RM**





# Design Flag

emergency



**A** **archieco** : clean and elegant design lines with surfaces that can be painted together with the wall, made of recyclable materials.

**☆** Simple, minimalist design for a highly versatile luminaire.

**💡** Light diffusion through a sheet of transparent methacrylate that allows great uniformity of illumination of the pictogram.

**🔧** One luminaire for all types of mounting, edge mounted on wall, edge mounted on ceiling and single-sided.

## Applications

Services, offices, cinemas, hotels, shopping centres, museums, shops, design showrooms

## Characteristics

**Power supply** 230VAC ± 10%, 50÷60Hz

**Mounting** Wall, ceiling

**Recharging time** 12h

**Housing** Extruded aluminium white RAL 9003

**Diffuser** Transparent polycarbonate

**Compliance** EN 60598-1, EN 60598-2-22, UNI EN 1838, UNI 11222, EN 62034

**SURFACE TREATMENT WHICH ALLOWS IT TO BE PAINTED EVEN WITH COMMON WALL PAINTS**

Dimensions mm				Distance of visibility (DV)
L	B	H	H1	
274	183	33	78	36m

	Order Code	W	Description	Version	Autonomy h	Battery	Distance of visibility DV	Input power		Weight Kg	Packaging Single/Multi pack	
								DC	AC			
TR	18400		DESIGN FLAG SE/SA TR RM	SA/SE	1/2/3	LiFe 3.2V 1.5Ah	36m		3W			STANDARD
AT - OPT	18401		DESIGN FLAG SE/SA OPT	SA/SE	1/1.5/2/3/8	2x LTO 7.2V 0.5AH	36m					CENTRALISED SELF-TESTING
	LG	Standalone luminaires with Centralised Diagnostics integrating the Module Order No. 15036										
	LGFM	Standalone luminaires with Centralised Radio Diagnostics integrating the Module Order Code 15037										
	DALI	Standalone luminaires with Dali Centralised Diagnostics integrating the Module Order Code 15038										
LG230	17908		DESIGN FLAG LGS230				36m	2.6W	6.1VA			CENTRALISED BATTERY
LG24	17909		DESIGN FLAG LGS24				36m	2.5W				
HT230	17910		DESIGN FLAG HT				36m	3.1W	6.6VA			

## ACCESSORIES - to be ordered separately



**LG - LGFM - DALI MODULE** (AT-OPT version only)  
**LG** - Order Code **15036**  
**LGFM** - Order Code **15037**  
**DALI** - Order Code **15038**

**LG** **LGFM** **DALI**



**RM INIBIT REMOTE CONTROL**  
 RM for TR versions only  
 Order Code **2730**

**RM**



# Ironflag

emergency



IP40
IK05
850°
Batt. LiFe +40°C 0°C
Batt. LTO +45°C -20°C



Designed for durability with an aluminium housing and a PMMA screen.



Signage suitable for any situation. It can be edge mounted, single-sided or suspended. Available in many versions, both for self-contained and centralised battery systems. Special accessories for overhead door lighting and laser signage with Modulo Orma.



Easily detachable housing with ample space inside for quick wiring to the network or to various centralised systems available.

## Applications

Services, hotels, hospitals, schools, offices, commercial activities

## Characteristics

**Power supply** 230VAC ± 10%, 50÷60Hz

**Mounting** Wall, ceiling, recessed, suspended and above door

**Recharging time** 12h

**Housing** Unpainted aluminium

**Screen** Clear polycarbonate

**Compliance** EN 60598-1, EN 60598-2-2, EN 60598-2-22, UNI EN 1838, UNI 11222, EN 62034

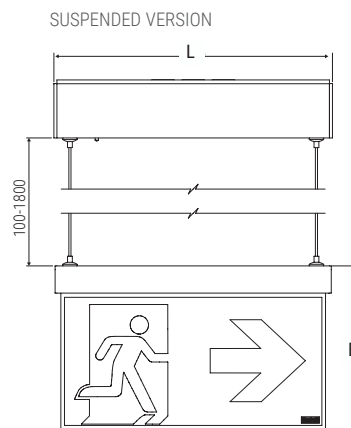
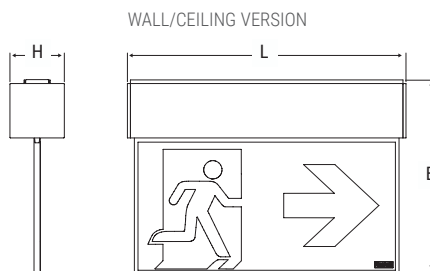

Version	Dimensions mm			Distance of visibility (DV)
	L	B	H	
Standard	230	160	45	20m
	330	210	45	30m
Suspended	230	135	45	20m
	330	185	45	30m



	Version	Order Code	Description	Autonomy h	Battery	Distance of visibility DV	Input power		Weight Kg	Packaging Single/Multi pack		
							DC	AC				
TR	Wall/ceiling	19800	IRONFLAG 20M SA RM	1/2/3	LiFe 3.2V 1.5Ah	20m		3W	0.5	STANDARD		
	Wall/ceiling	19801	IRONFLAG 30M SA RM	1/2/3	LiFe 3.2V 1.5Ah	30m		3W	0.8			
	Suspended	19802	IRONFLAG PEND 20M SA RM	1/2/3	LiFe 3.2V 1.5Ah	20m		3W	0.6			
	Suspended	19803	IRONFLAG PEND 30M SA RM	1/2/3	LiFe 3.2V 1.5Ah	30m		3W	1			
AT - OPT	Wall/ceiling	19810	IRONFLAG AT OPT 20M SA 8LTO	1/1.5/2/3/8	LTO 7.2V 0.5AH	20m		5W	0.5	CENTRALISED SELF-TESTING		
	Wall/ceiling	19811	IRONFLAG AT OPT 30M SA 8LTO	1/1.5/2/3/8	2xLTO 7.2V 0.5AH	30m		5W	0.9			
	Suspended	19812	IRONFL PEND AT OPT 20M SA 8LTO	1/1.5/2/3/8	LTO 7.2V 0.5AH	20m		5W	0.6			
	Suspended	19813	IRONFL PEND AT OPT 30M SA 8LTO	1/1.5/2/3/8	2xLTO 7.2V 0.5AH	30m		5W	1			
		LG	Standalone luminaires with Centralised Diagnostics integrating the Module Order No. 15036									
		LGFM	Standalone luminaires with Centralised Radio Diagnostics integrating the Module Order Code 15037									
		DALI	Standalone luminaires with Dali Centralised Diagnostics integrating the Module Order Code 15038									
LG230	Wall/ceiling	17890	IRONFLAG LGS230 20M			20m	2.6W	6.1VA	0.5	CENTRALISED BATTERY		
	Wall/ceiling	17891	IRONFLAG LGS230 30M			30m	4.1W	8.3VA	0.8			
	Suspended	17892	IRONFLAG PEND LGS230 20M			20m	2.6W	6.1VA	0.6			
	Suspended	17893	IRONFLAG PEND LGS230 30M			30m	4.1W	8.3VA	0.9			
LG24	Wall/ceiling	17894	IRONFLAG LGS24 20M			20m	2.5W		0.5	CENTRALISED BATTERY		
	Wall/ceiling	17895	IRONFLAG LGS24 30M			30m	3.7W		0.8			
	Suspended	17896	IRONFLAG PEND LGS24 20M			20m	2.5W		0.6			
	Suspended	17897	IRONFLAG PEND LGS24 30M			30m	3.7W		0.9			
HT230	Wall/ceiling	17898	IRONFLAG HT 20M			20m	3.1W	6.6VA	0.5	CENTRALISED BATTERY		
	Wall/ceiling	17899	IRONFLAG HT 30M			30m	4.7W	9.5VA	0.8			
	Suspended	17900	IRONFLAG PEND HT 20M			20m	3.1W	6.6VA	0.6			
	Suspended	17901	IRONFLAG PEND HT 30M			30m	4.7W	9.5VA	0.9			





### ORMA LASER MODULE

Laser micro-projector that emits a bright and prominent arrow-shaped asymmetrical conical beam, producing a virtual pictogram to indicate the nearest escape route. To position the image on the ground at the most suitable point and with the correct signal orientation, simply rotate the body of the device.

### ACCESSORIES - included

	<b>SUSPENDED MOUNTING CABLES</b> SUSPENDE version only
	<b>LH/RH/DOWN SCREENS</b> Screen printing on opal polycarbonate
	<b>WALL BRACKET</b> WALL/CEILING version only

### ACCESSORIES - to be ordered separately

	<b>ORMA LASER</b> TR, AT-OPT versions only Installation as an alternative to Code 19882 Order Code <b>19884</b>	<b>TR</b> <b>AT-OPT</b>
	<b>LIGHT ABOVE DOOR</b> TR, AT-OPT versions only Installation as an alternative to Code 19884 Order Code <b>19882</b>	<b>TR</b> <b>AT-OPT</b>

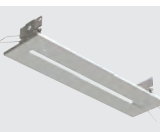
	<b>RM INIBIT REMOTE CONTROL</b> RM for TR versions only Order Code <b>2730</b>	<b>RM</b>
	<b>RECESSED MOUNTING KIT</b> <b>20m</b> - Order Code <b>19880</b> <b>30m</b> - Order Code <b>19881</b>	

# Exit

emergency



IP40

850°

IK05



Batt. LTO  
+45°C  
-20°C

Batt. NiMH  
+40°C  
0°C



Signage suitable for any industrial or services installation. Available in three sizes with a distance of visibility (DV) of 20, 30 or 60 m. Version with fast-charging Titanium Battery (LTO), with 10 years of service life and for extreme working temperatures.



Screen-printed screen for more uniform signal illumination



Innovative concealed fixing system. The same bracket, supplied, is used for both ceiling and edge mounting.

## Applications

Services, industry

## Characteristics

**Power supply** 230VAC ± 10%, 50÷60Hz

**Mounting** Wall, false ceiling, ceiling with rods and cables, edge mounting on wall, edge mounting on ceiling, three-phase track

**Recharging time** 12hrs with LTO battery

**Housing** Polycarbonate, white RAL 9003

**Screen** Clear polycarbonate

**Compliance** EN 60598-1, EN 60598-2-22, UNI EN 1838, UNI 11222, EN 62034

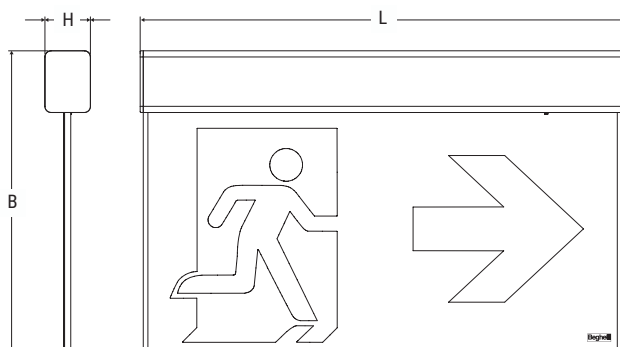

W	Dimensions mm			Distance of visibility (DV)
	L	B	H	
2	299	155	30	20m
3	314	194	30	30m
6	629	355	30	60m



	Order Code	W	Description	Version	Autonomy h	Battery	Distance of visibility DV	Input power		Weight Kg	Packaging Single/ Multi pack	
								DC	AC			
TR	4320		EXIT DF20M SA RM	SA/SE	1/2/3	NiMh 3.6V 750mAh	20m		2.5W	0.3	1/6	STANDARD
	4321		EXIT DF30M SA RM	SA/SE	1/2/3	NiMh 3.6V 1.5Ah	30m		3.5W	0.5	1/6	
	4322		EXIT DF60M SA RM	SA/SE	1/2/3	2xNiMH 3.6V 1.2Ah	60m		6.5W	1	1/3	
AT - OPT	4380		EXIT AT OPT 20M SA 8LTO	SA/SE	1/1.5/2/3/8	LTO 7.2V 0.5AH	20m		7.5W	0.3	1/6	CENTRALISED SELF-TESTING
	4381		EXIT AT OPT 30M SA 8LTO	SA/SE	1/1.5/2/3/8	2x LTO 7.2V 0.5AH	30m		7.5W	0.5	1/6	
	<b>LG</b>	Standalone luminaires with Centralised Diagnostics integrating the Module Order No. 15036										
	<b>LGFM</b>	Standalone luminaires with Centralised Radio Diagnostics integrating the Module Order Code 15037										
	<b>DALI</b>	Standalone luminaires with Dali Centralised Diagnostics integrating the Module Order Code 15038										
LG230	17911		EXIT LGS230 DF20M				20m	2.5 W	6.1 VA	0.5	1/6	CENTRALISED BATTERY
	17912		EXIT LGS230 DF30M				30m	3.5 W	8.3 VA	0.5	1/6	
	17913		EXIT LGS230 DF60M				60m	7.0 W		1.0	1/6	
LG24	17914		EXIT LGS24 DF20M				20m	2.5 W		0.5	1/6	CENTRALISED BATTERY
	17915		EXIT LGS24 DF30M				30m	3.5 W		0.5	1/6	
	17916		EXIT LGS24 DF60M				60m	7.0 W		1.0	1/6	
HT230	17917		EXIT HT DF20M				20m	2.5 W	6.6 VA	0.5	1/6	CENTRALISED BATTERY
	17918		EXIT HT DF30M				30m	3.5 W	9.5 VA	0.5	1/6	
	17919		EXIT HT DF60M				60m	7.0 W		1.0	1/6	

## ACCESSORIES - included



**LH/RH/DOWN SCREENS**  
Screen printing on opal polycarbonate



**UNIVERSAL BRACKET**

## ACCESSORIES - to be ordered separately



**CEILING RECESSED MOUNTING ACCESSORY**  
Distance of visibility (DV) 20-30 m  
Order Code **4312** (20 m) - **4313** (30 m)



**SUSPENDED MOUNTING ACCESSORY WITH CABLES**  
Order Code **14771**



**THREE-PHASE TRACK KIT**  
Order Code **4319**



**EDGE MOUNTING WALL BRACKET**  
60m versions only  
Order Code **19045**



**SUSPENDED MOUNTING RODS**  
250 - 500 - 1000 mm  
Order Code **4315** (250 mm) - **4316** (500 mm) - **4317** (1000 mm)



**LG - LGFM - DALI MODULE (AT-OPT version only)**  
**LG** - Order Code **15036**  
**LGFM** - Order Code **15037**  
**DALI** - Order Code **15038**

**LG** **LGFM** **DALI**



**RM INIBIT REMOTE CONTROL**  
RM for TR versions only  
Order Code **2730**

**RM**

# UpLED Bandiera IP65

emergency



 IP65 flag with a 40m visibility distance.

 Wall or ceiling mounting and accessories for special mounting, such as the three-phase track kit.

 Quick installation with IP65 accessories with snap-on fixing of the flag screen without the need for tools.

## Applications

Industry, services, hospitals, schools, retail where a high visibility distance is required

## Characteristics

**Power supply** 230VAC  $\pm$  10%, 50÷60Hz

**Mounting** Wall, ceiling, three-phase track

**Housing** Polycarbonate, white RAL 9003

**Screen** Opal polycarbonate

**Compliance** EN 60598-1, EN 60598-2-22, UNI EN 1838, UNI 11222, EN 62034

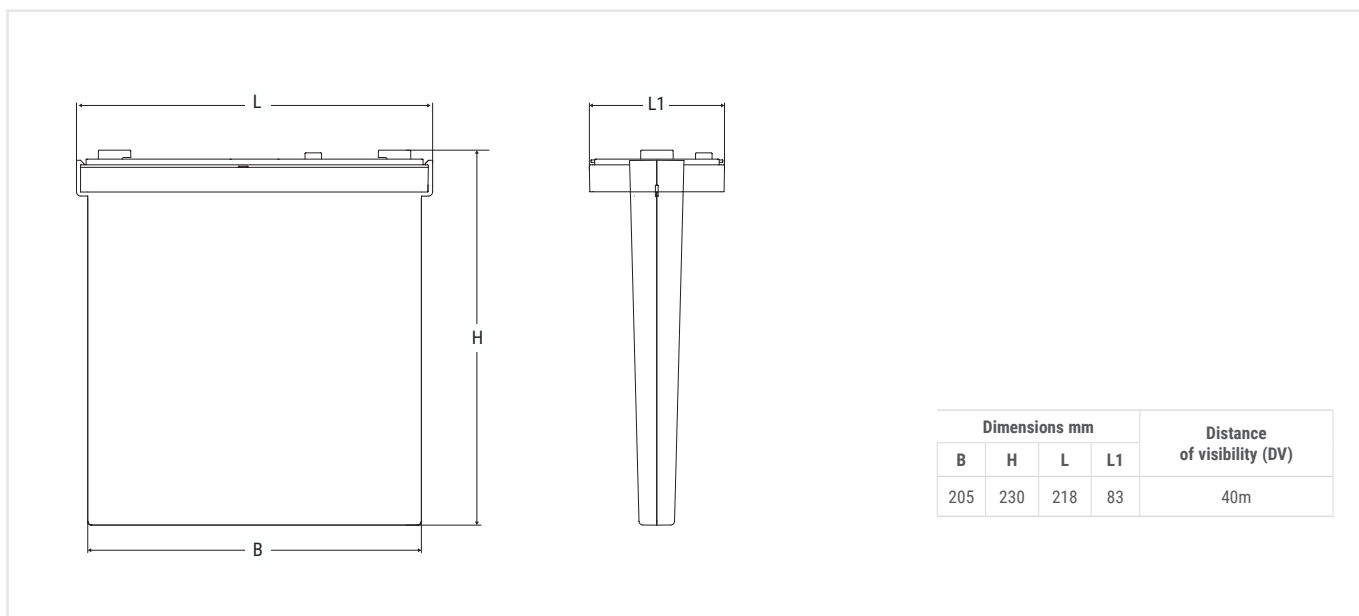

090

	Order Code	W	Description	Version	Autonomy h	Battery	Distance of visibility DV	Input power		Weight Kg	Packaging Single/ Multi pack	STD.	
								DC	AC				
TR	824BA		UP LED BAND 824BA SE/SA IP65 RM	SA/SE	1.5	NiCd 3.6V 0.75Ah	40m		2W	0.5	1/12		
AT-OPT	4372BA		UP LED BAND IP65 ATOPT SA 8LTO	SA/SE	1/1.5/2/3/8	LTO 4.8V 0.5Ah	40m		7.5W	0.3	1/12	CENTRALISED SELF-TESTING	
	LG	Standalone luminaires with Centralised Diagnostics integrating the Module Order No. 15036											
	LGFM	Standalone luminaires with Centralised Radio Diagnostics integrating the Module Order Code 15037											
	DALI	Standalone luminaires with Dali Centralised Diagnostics integrating the Module Order Code 15038											

## ACCESSORIES - included

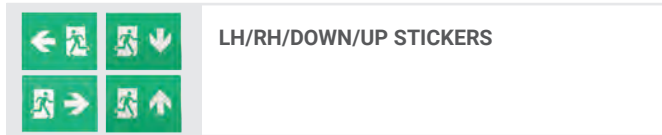
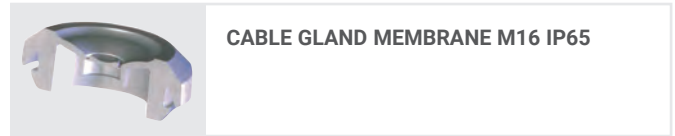
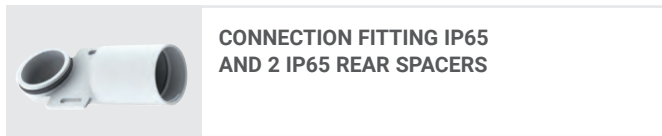

## ACCESSORIES - to be ordered separately

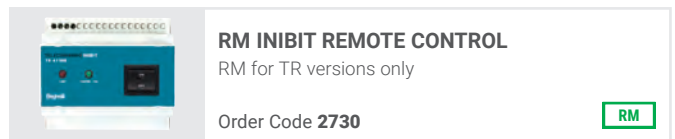
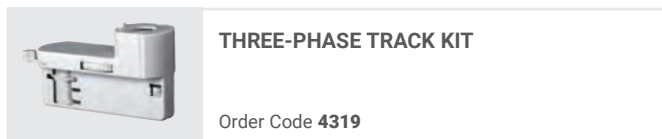

# Plug&Light LED Inverter

emergency



Inverter for compact LED luminaires thanks to the integrated battery.



Equipped with cable gland protection covers to allow installation outside the luminaire, without a protection box.



Plug&Light technology for immediate wiring with SD series luminaires - Auto-dimmer already prepared for connection.

## Applications

Services, industry, inside IP65 luminaires

## Characteristics

**Power supply** 230VAC  $\pm$  10%, 50 $\div$ 60Hz

**Output voltage** 20 - 60 VDC (Order Code 19358, 19359), 60 - 180VDC (Order Code 19367)

**Max. output current** 160 mA

**Status LED** Two colours with PC light guide (BCS)

**Housing** Polycarbonate

**Compliance** EN 61347-2-7, EN 61347-1, EN 60598-1

IP40

IP65

IK08

850°



Batt. NiMH

Batt. NiCd

+40°C  
0°C

+40°C  
0°C

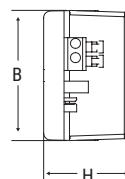
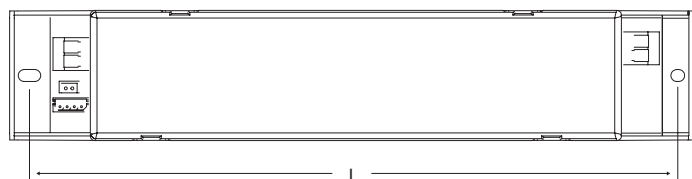
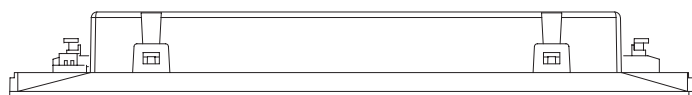

Version	Dimensions mm		
	L	B	H
IP40	239	46	30
IP65	301	139	55

092



### EXAMPLE OF FLUX CALCULATION FOR BS 100 LED (SMART DRIVER) WITH LED INVERTER WITH 1H OF AUTONOMY (Order 19358)

The LED Inverter can guarantee the maximum lighting performance that the luminaire on which it is installed can achieve. Please find below the calculation method and an example for determining the Rated Flux in emergency mode

P= Inverter rated power (in the version 1h = 3.2W)  
 Fn= Rated luminaire flux (for BS100 LED = 8350lm)  
 Pn= Rated power (for BS100 LED = 64W)

$$\text{Flux} = P \text{ inverter} \times \frac{F_n}{P_n} \text{ where: } \text{Flux} = 3.2 \times \frac{8350}{64} = 417\text{lm}$$

### BATTERY CONTROL SYSTEM

The signalling LED follows new protocols linked to compliance with standard IEC EN 60598-2-22, where it is expressly required to signal battery malfunctioning, which is instantly signalled by the appearance of the red colour on the multi-coloured signalling LED (BCS Battery Control System).



Green indicator LED:  
**LUMINAIRE  
 IN FULL WORKING  
 ORDER**



Red indicator LED:  
**BATTERY NOT  
 CONNECTED**



	Order Code	P out Max W	Description	Version	Autonomy h	Battery	FLUX SE lm	FLUX SA lm	Input power		Weight Kg	Packaging Single/Multi pack	
									DC	AC			
TR	<b>IP40</b>												
	19358	3.2	INV PLUG&LIGHT LED SE/SA 1H 20-60V	SA/SE	1	NiCd 7.2V 0.75Ah			1W		0.3	1/12	
	19359	3	INV PLUG&LIGHT LED SE/SA 3H 20-60V	SA/SE	3	NiMH 7.2V 1.5Ah			1W		0.3	1/12	
	19367	3.2	INV PLUG&LIGHT LED SE/SA 1H 60-180V	SA/SE	1	NiCd 7.2V 0.75Ah			1W		0.3	1/12	
	19371	3	INV PLUG&LIGHT LED SE/SA 3H 60-180V	SA/SE	3	NiMH 7.2V 1.5Ah			1W		0.3	1/12	
	<b>IP65</b>												
	19368	3	INV PLUG&LIGHT LED SE/SA 3H 20-60V IP65	SA/SE	3	NiMH 7.2V 1.5Ah			1W		0.8	1/12	
	19373	3	INV PLUG&LIGHT LED SE/SA 3H 60-180V IP65	SA/SE	3	NiMH 7.2V 1.5Ah			1W		0.8	1/12	

### ACCESSORIES - included

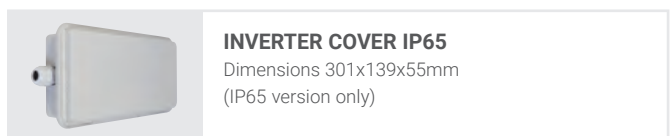
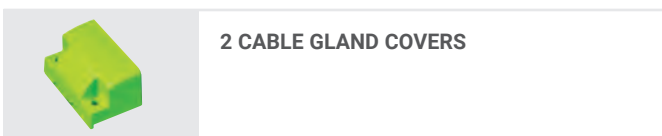



# LED Inverter

emergency

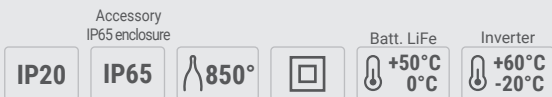

High-performance LED inverter with output current control and constant peak current PWM modulation to drive the LED module optimally without distorting the luminous flux and the colour temperature (K) of the LEDs.



Wide range for self-testing or centralised control luminaires, both wired and radio. Autoripara battery to double the autonomy.

## Applications

Services, industry, in high performance IP65 luminaires or with a IP65 enclosure installed.

## Characteristics

**Power supply** 230VAC  $\pm 10\%$ , 50 $\div$ 60Hz

**Output voltage** 5V - 55V

**P in max driver** 1500VA

**V in max driver** 250VAC

**Recharging time\*** 12hrs

**Max. output current** 500mA

**Status LED** Two colours

**Housing** Polycarbonate

**Compliance** EN 61347-2-7, EN 61347-2-13, EN 61347-1, EN 62034

\* The time refers to the battery included with the luminaire. The charging time doubles when the Autoripara battery is used.

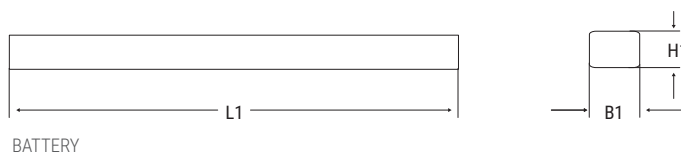
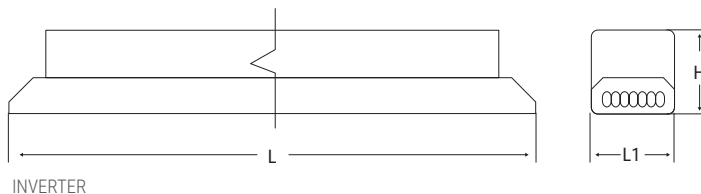

Dimensions mm					
L	B	H	L1	B1	H1
232	30	26	72	60	20



### EXAMPLE OF FLUX CALCULATION FOR BS 100 LED (SMART DRIVER) WITH LED INVERTER WITH 1H OF AUTONOMY (Order 19355L)

The LED Inverter can achieve an excellent lighting performance of the luminaire on which it is installed. Please find below the calculation method and an example for determining the Rated Flux in emergency mode

P= Inverter rated power (in the version 1h = 7W)  
 Fn= Rated luminaire flux (for BS100 LED = 8350lm)  
 Pn= Rated power (for BS100 LED = 64W)

$$\text{Flux} = P \text{ inverter} \times \frac{F_n}{P_n} \text{ where:}$$

$$\text{Flux} = 7 \times \frac{8350}{64} = 913\text{lm}$$

The calculation does not take into account the improved efficiency of the luminaire when driven with very low power compared to the nominal values, in which case the fluxes are underestimated.

### POWER TREND ACCORDING TO LED VOLTAGE

The output power is subordinated to the maximum output current of 500mA (e.g., with the inverter set to 1h of autonomy, it will guarantee a 7W output when only used to power an LED set with Vled>14Volt; below this voltage, the power is reduced as shown in the graph.

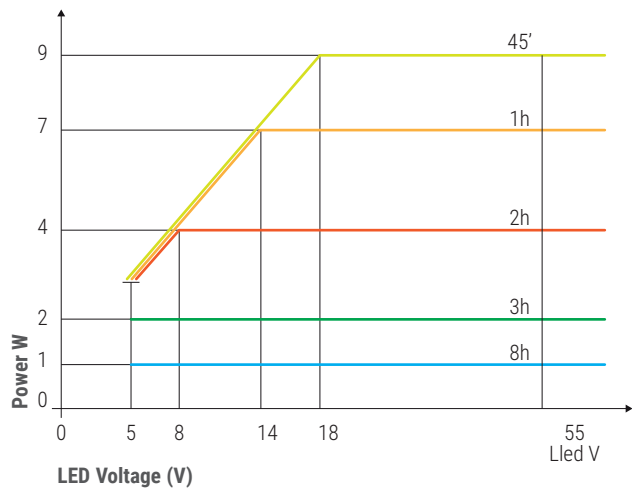

Order Code	P out Max W	Description	Version	Autonomy h	Battery	P out W	Batt. AUTORIPARA OPTIONAL Autonomy h	Input power		Weight Kg	Packaging Single/Multi pack
								DC	AC		
19355L	9	INVERTER LED AT/LG AR 9W 55V LIFE	SA/SE	0.75/1/2/3/8	LiFe HT 9.6V 1.5Ah	9/7/4/2/1	1.5/2/4/6/16	2W		0.3	1/12

**LGFM** Standalone luminaires with Centralised Radio Diagnostics integrating the Module Order Code 19375

### ACCESSORIES - to be ordered separately



**AR - AUTORIPARA BATTERY**  
 Compatible with Order Code 19355L  
 Order Code **RA06** - LIFE 9.6V 1.5Ah



**INVERTER COVER IP65**  
 Dimensions 301x139x55mm  
 Order Code **19376**



**LGFM module**  
 Order Code **19375 (LGFM)**

# GranLuce LED inverter

emergency



Accessory IP65 enclosure

IP20 IP65 850°

Batt. LTO +45°C -20°C

Batt. LiFe +50°C -0°C

Inverter +60°C -20°C



LED inverter with a luminous flux of up to 2000lm, for high-performance luminaires. Extreme working conditions thanks to special lithium batteries.



Wide range for Autotest and radio centralised control luminaires. Autoripara battery to double the autonomy.



Quick wiring and optional IP65 enclosure for installation outside the luminaire.

## Applications

Services, industry, in high performance IP65 luminaires or with a IP65 enclosure installed even outdoors.

## Characteristics

**Power supply** 230VAC  $\pm$  10%, 50÷60Hz

**Output voltage** 5V - 55V

**P in max driver** 1500VA

**V in max driver** 250VAC

**Recharging time\*** 12hrs

**Max. output current** 500mA

**Status LED** Two colours

**Housing** Polycarbonate

**Compliance** EN 61347-2-7, EN 61347-2-13, EN 61347-1, EN 62034

\* The time refers to the battery included with the luminaire. The charging time doubles when the Autoripara battery is used.

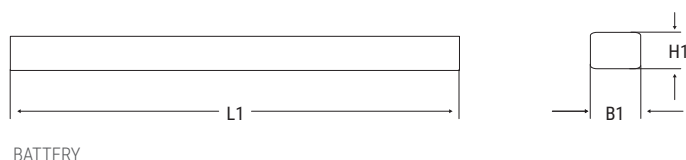
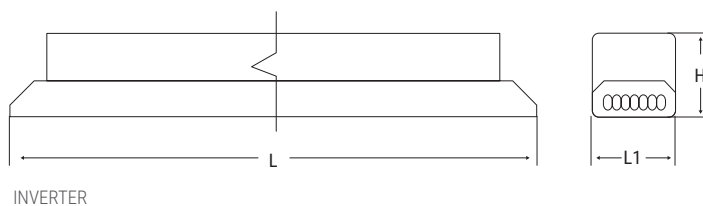

Version	Dimensions mm					
	L	B	H	L1	B1	H1
LTO	232	30	26	198	37	19
LiFe	232	30	26	132	37	19



1h autonomy 1304lm flux

### EXAMPLE OF FLUX CALCULATION FOR BS 100 LED (SMART DRIVER) WITH LED INVERTER WITH 1H OF AUTONOMY (Order 19390)

The GranLuce LED Inverter can to guarantee the maximum lighting performance that the luminaire on which it is installed can achieve. Please find below the calculation method and an example for determining the Rated Flux in emergency mode

P= Inverter rated power (in the version 1h = 10W)  
 Fn= Rated luminaire flux (for BS100 LED = 8350lm)  
 Pn= Rated power (for BS100 LED = 64W)

$$\text{Flux} = P \text{ inverter} \times \frac{F_n}{P_n} \text{ where: } \text{Flux} = 10 \times \frac{8350}{64} = 1304\text{lm}$$

The calculation does not take into account the improved efficiency of the luminaire when driven with very low power compared to the nominal values, in which case the fluxes are underestimated.

### POWER TREND ACCORDING TO LED VOLTAGE

The output power is subordinated to the maximum output current of 500mA (e.g. with the inverter set to 1h of autonomy, it will guarantee a 10W output when only used to power an LED set with Vled>20Volt; below this voltage, the power is reduced as shown in the graph.

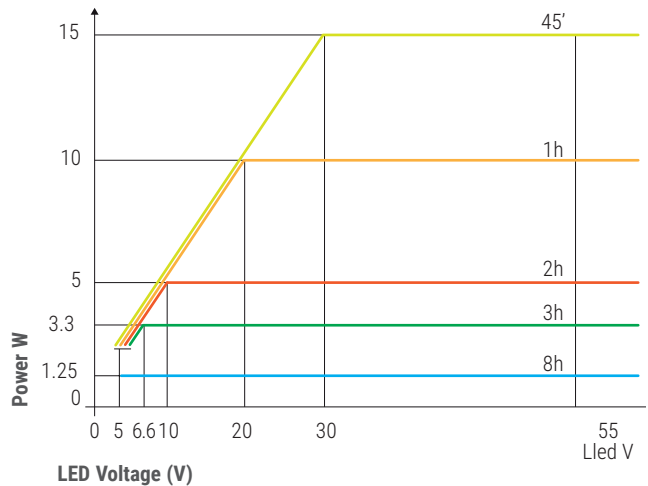

	Order Code	P out Max W	Description	Version	Autonomy h	Battery	P out W	Batt. AUTORIPARA OPTIONAL Autonomy h	FLUX SA lm	Input power		Weight Kg	Packaging Single/ Multi pack
										DC	AC		
LG	19390	15W	INVERTER GL AT/LG AR 15W 55V LTO	SA/SE	0.75/1/2/3/8	LTO 14.4V 1.2Ah	15/10/5/3.3/1.25	1.5/2/4/6/16			3.7	0.3	1/12
	19391*	15W	INVERTER GL AT/LG AR 15W 55V LIFE	SA/SE	0.75/1/2/3/8	LiFe 12.8V 1.5Ah	15/10/5/3.3/1.25	1.5/2/4/6/16			3.7	0.3	1/12
	LGFM	Standalone luminaires with Centralised Radio Diagnostics integrating the Module Order Code 19375											

\* 5-year warranty

### ACCESSORIES - to be ordered separately



**AR - AUTORIPARA BATTERY**  
 Compatible with Order Code **19390**

Order Code **RA07** - LTO 14.4V 1.2Ah



**INVERTER COVER IP65**  
 Dimensions 301x139x55mm

Order Code **19376**



**AR - AUTORIPARA BATTERY**  
 Compatible with Order Code **19391**

Order Code **RA08** - LiFe 12.8V 1.5Ah



**LGFM module**

Order Code **19375 (LGFM)**

**LGFM**

# Cablecom Connect CBL Control Unit

emergency



Control unit for CBL Cablecom series luminaires with single power supply wired connection for data transmission and integrated WiFi for remote management from the Beghelli NuBe Cloud.



Newly installed luminaires are preconfigured in AutoTest AT mode. As soon as the CBL Control Unit is connected, they are automatically recognised as centralised luminaires and all programming and centralised monitoring functions are immediately available directly via the Control Unit buttons. By downloading the B.Connect APP, you can connect to the Control Unit and automatically configure the entire system, start functional and autonomy tests, change the parameters of each device and enable advanced functions such as Rest Mode and Infinity Mode.

## Applications

Industry, services

## Characteristics

**Power supply** 230VAC  $\pm 10\%$ , 50=60Hz

**Mounting** 4 DIN rail modules

**Equipment** back-up battery

**Managed luminaires** up to 32 CBL system luminaires

**Connection interface**

WiFi - AccesPoint (AP) mode and Client (STA) mode, Bluetooth (not enabled)

**Management software**

B.connect App, NuBe, Cablecom App

**Compliance** EN62034, EN50172, EN60950-1 2014/53/EU

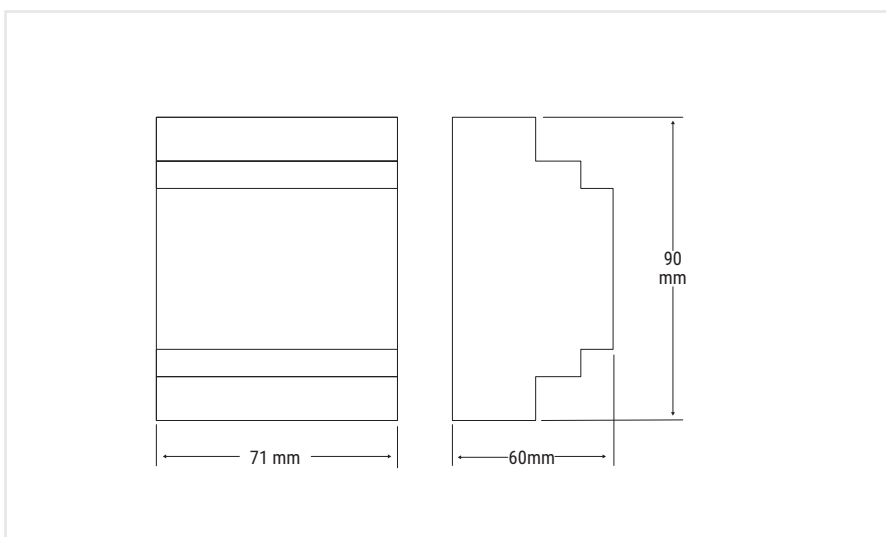

098



## FUNCTIONS

- Modular system
- Luminaires operating in both AutoTest and Centraltest CBL modes.
- Programmable autonomy (1-1.5 -2-3-8hrs)
- Delayed testing for part of the system (even/odd)
- Rotary switch for manual programming
- Possibility of remote control via B.connect APP
- Possibility of remote control via PC with the NuBe portal (in addition to GSM, Ethernet, USB, RS232 interfacing)
- Possibility of integration with Building Automation
- Centralised configuration operations
- Activation of Rest Mode function
- Activation of Infinity Mode function
- Automatic download of the system LogBook in PDF format, as required by the EN UNI 11222 Standard

## INFINITY MODE, THE INFINITE AUTONOMY SYSTEM

The Infinity Mode function can be activated on all Cablecom (CBL) luminaires, either with the single product in AutoTest AT version (via the B.connect App) or in CentralTest CT version, by activating the specific mode from the control panel of the CableCom Connect Control Unit. Thanks to the CableCom communication BUS, which allows the same cables to be used

both for power supply and for data transmission, in the event of a blackout, when the rated autonomy is over, the CBL Bus will supply the electricity needed to keep the luminaire switched on over an infinite autonomy (at a reduced flux, power supplied from the CableCom CBL BUS line).

	Order Code	Description	Number of luminaires	Number of DIN rail modules	Weight Kg	Packaging Single/ Multi pack
AT-CBL	20151	CABLECOM CONNECT CONTROL UNIT	32	4	0.2	1

## ACCESSORIES - to be ordered separately



**GSM MODULE**  
With Ethernet LAN input and power supply (1+1 DIN)  
SIM card slot (included)  
Order Code **20157**

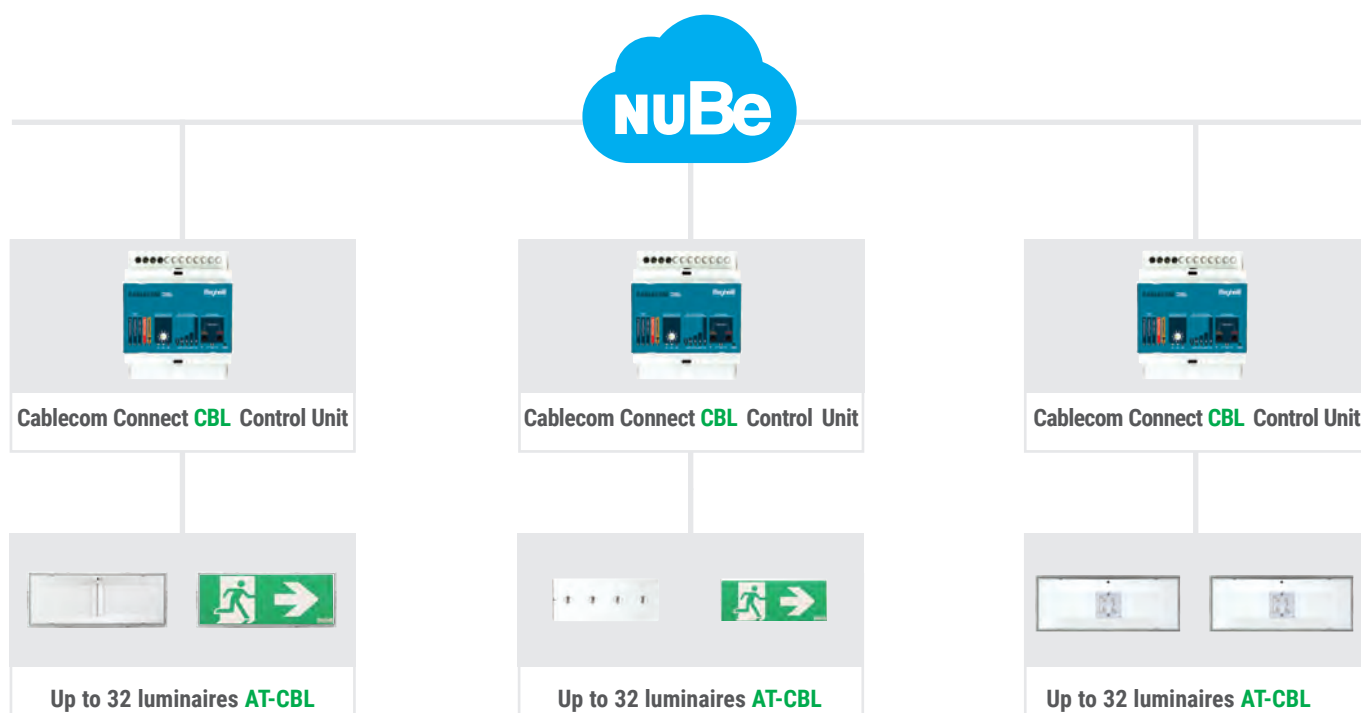

# Logica Connect LG Control Unit

emergency



Control unit for Logica LG series emergency luminaires with BUS control of the luminaires and integrated WiFi for remote management from the Beghelli NuBe Cloud.



The LG system allows to control a very high number of luminaires (up to 3968) thanks to the combination with the Supervisor Control Unit that, in turn, can control up to 31 LG Control Units. The system is particularly versatile in that, thanks to the Supervisor Control Unit, it overcomes any compatibility problems in systems where there are existing LG Control Units of an older generation, which are in any case integrated into the set and shared in the Beghelli NuBe Cloud.

## Applications

Industry, services

## Characteristics

Power supply 230VAC  $\pm 10\%$ , 50÷60Hz

**Mounting** 4 DIN rail modules

**Equipment** Relay output and buffer battery

**Managed luminaires** up to 128 devices per each LG Control Unit; by integrating the Supervisor Control Unit, it is possible to connect 31 control units for a total of 3968 luminaires that can be managed from a single point. In mixed systems, up to 64 DALI devices + 32 LG devices can be controlled.

### Connection interface

WiFi - AccesPoint (AP) mode and Client (STA) mode, Ethernet, Bluetooth (not activated), RS485, 4 x potential-free inputs, 1 x 230V input

### Management software

B.connect App, NuBe

**Compliance** EN60950-1, EN62034, EN50172, 2014/53/EU

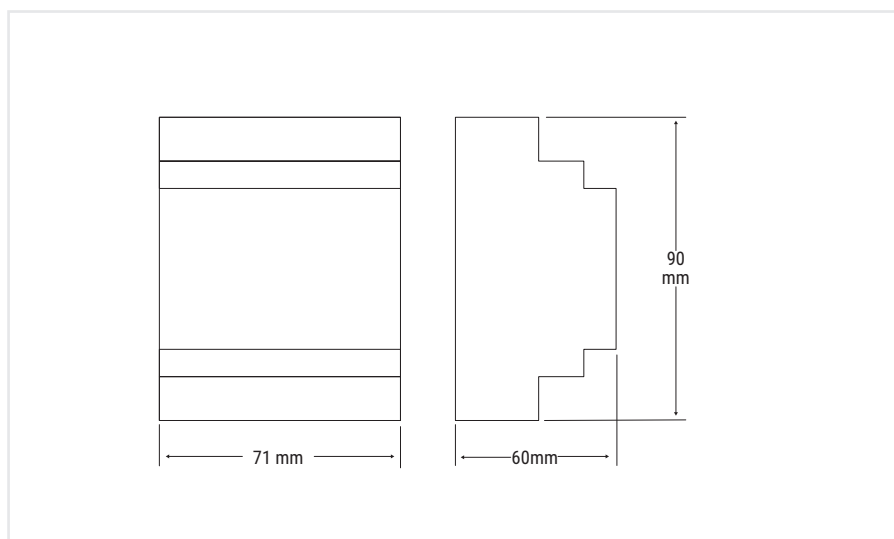

## FUNCTIONS

- Modular system
- Luminaires operating in both AutoTest and Centraltest CBL modes.
- Programmable autonomy(1hour / 3hours)
- Delayed testing for part of the system (even/odd)
- Bus Logica wired connections
- Bus DALI-compatible for the management of DALI (LOGICA) luminaires
- Possibility of remote control via B.connect APP
- Possibility of remote control via PC with the NuBe portal (in addition to GSM, Ethernet, USB, RS232 interfacing)
- Possibility of integration with Building Automation
- Centralised configuration operations
- 16 programmable luminaire groups
- 16 programmable brightness scenes

	Order Code	Description	Number of luminaires	Number of DIN rail modules	Weight Kg	Packaging Single/ Multi pack
LG	12100C	LOGICA CONNECT LG CONTROL UNIT	128	4	0.2	1

## ACCESSORIES - to be ordered separately



**GSM MODULE**  
With Ethernet LAN input and power supply (1+1 DIN)  
SIM card slot (included)  
Order Code **20157**



**SUPERVISOR CONTROL UNIT**  
It connects up to 31 LG control units for a total of 3968 controlled luminaires  
Order Code **12131C**

## NuBe integration scheme for LG Connect systems with older generation LG systems

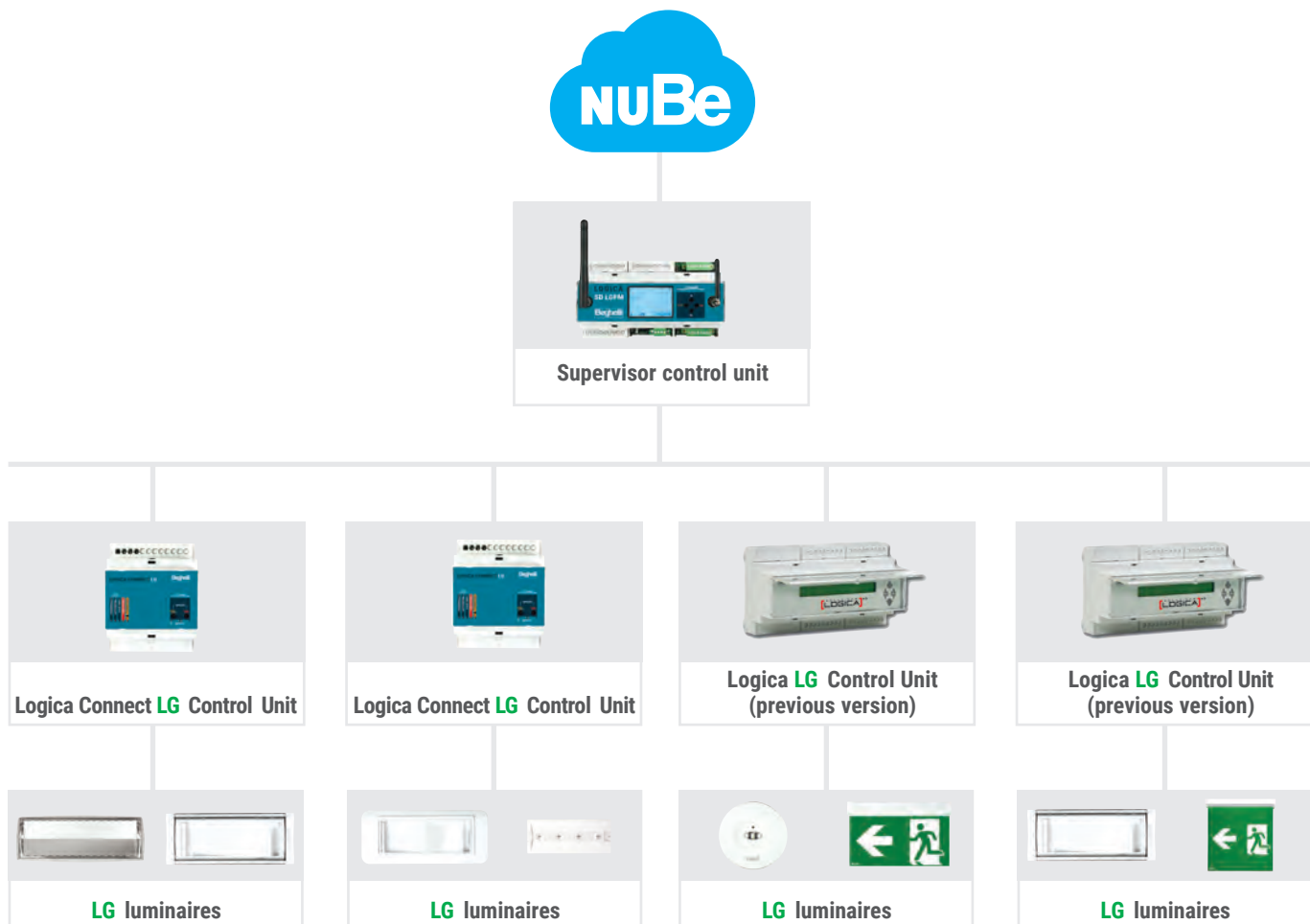

# Logica Connect LGFM Control Unit

emergency



Radio control unit for emergency luminaires of the Logica LGFM series with radio control of the luminaires and integrated WiFi for remote management from the Beghelli NuBe Cloud.



The LGFM system allows great flexibility during installation thanks to the radio system that connects the control unit to the luminaires and the luminaires between them without having to add a wired data transmission system. Secure radio transmission with a mesh communication network, where each luminaire acts as a repeater for the next luminaire

## Applications

Industry, services

## Characteristics

**Power supply** 230VAC  $\pm 10\%$ , 50÷60Hz

**Mounting** 4 DIN rail modules

**Equipment** Relay output

**Managed luminaires**

Up to 256 LGFM devices

**Connection interface**

Radio Spread Spectrum SFH DSSS  
WiFi - AccesPoint (AP) mode and Client (STA) mode, Ethernet (1 port), Bluetooth (not activated), RS485, 4 x potential-free inputs, 1 x 230V input

**Management software**

B.connect App, NuBe, Logica visual

**Memory card**

SD Card (not included)

**Compliance** EN60950-1, EN62034, EN50172, 2014/53/EU

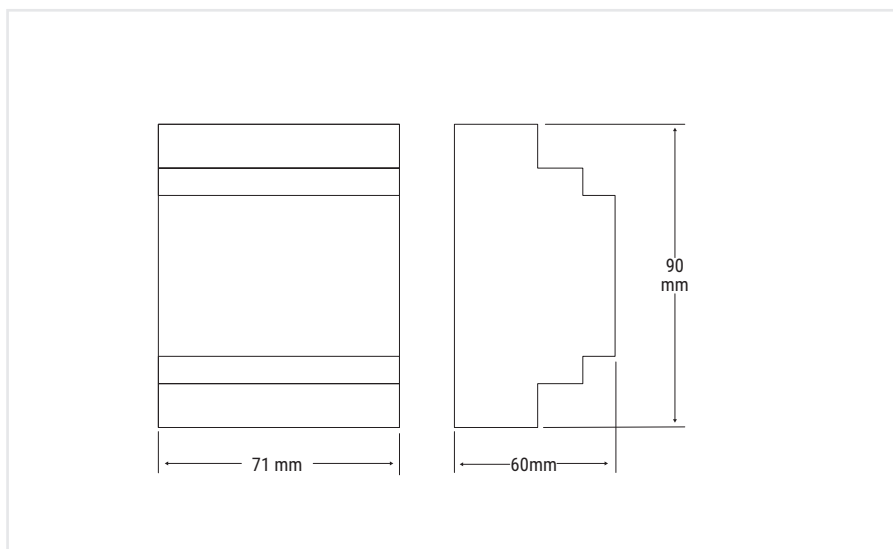

## FUNCTIONS

- Modular system
- Luminaires operating in both AutoTest and Centraltest LGFM modes.
- Programmable autonomy(1hour / 3hours)
- Delayed testing for part of the system (even/odd)
- Radio links with SFH DSS system
- Possibility of remote control via B.connect APP
- Possibility of remote control via PC with the NuBe portal (in addition to GSM, Ethernet, USB, RS232 interfacing)
- Possibility of integration with Building Automation
- Centralised configuration operations
- 16 programmable luminaire groups
- 16 programmable brightness scenes

## LOW POWER RADIO COMMUNICATIONS BASED ON SPREAD-SPECTRUM TECHNOLOGY UNLIMITED RADIO RANGE

The radio waves used by the Logica FM system are very low power to avoid any kind of interference and electromagnetic pollution. The power involved in radio communication is less than one hundredth of that emitted by a normal mobile phone. The signal transmitted by the Control Unit is received by the first luminaire in the "route" memorised during the control unit

start-up; each luminaire, equipped with a radio transceiver and an amplifier, receives and transmits the signal to the next appliance in the memorised "route".

All products in this range comply with the standards in the European Recommendation ERC/REC 70-03.

	Order Code	Description	Number of luminaires	Number of DIN rail modules	Weight Kg	Packaging Single/ Multi pack
LGFM	12128C	LOGICA CONNECT LGFM CONTROL UNIT	256	4	0.2	1

## ACCESSORIES - to be ordered separately



**GSM MODULE**  
With Ethernet LAN input and power supply (1+1 DIN)  
SIM card slot (included)  
Order Code **20157**

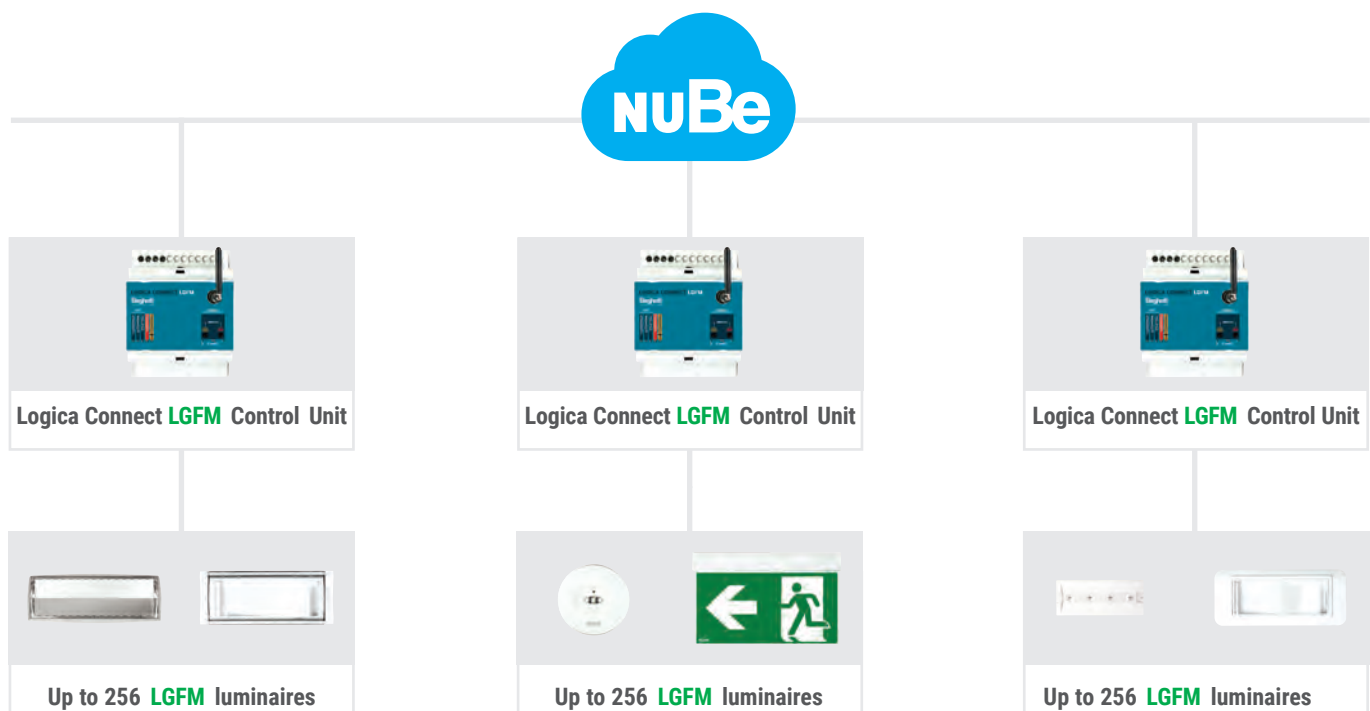



# Logica SD LGFM Control Unit

emergency



Control unit for luminaires (SD-X and SD-Radio) and emergency lighting (LGFM) with radio control of the luminaires and integrated WiFi for remote management from the Beghelli NuBe Cloud.



Various types of connections possible and simultaneous management of lighting and emergency. Possibility of acting on each individual luminaire and creating or activating lighting scenarios. Secure radio transmission with improved communication network, where each luminaire acts as a repeater for the next luminaire

## Applications

Industry, services

## Characteristics

**Power supply** 230VAC  $\pm 10\%$ , 50-60Hz

**Mounting** 9 DIN rail modules

**Managed luminaires** up to 996 manageable radio devices including lighting lamps, emergency lamps and home automation devices.

### Connection interface

SFH DSSS Radio Spread Spectrum on 16 channels, UMTS 4G slot mini SD (SIM included), WiFi - AccesPoint (AP) mode and Client (STA) mode, Ethernet, USB (2 ports), Bluetooth, RS485, RS232, 4 x IN ports and 2 x OUT ports

### Management software

B.connect App, NuBe, SD Manager, Logica visual

### Memory card

SD Card (not included)

**Compliance** EN60950-1, EN62034, EN50172, 2014/53/EU

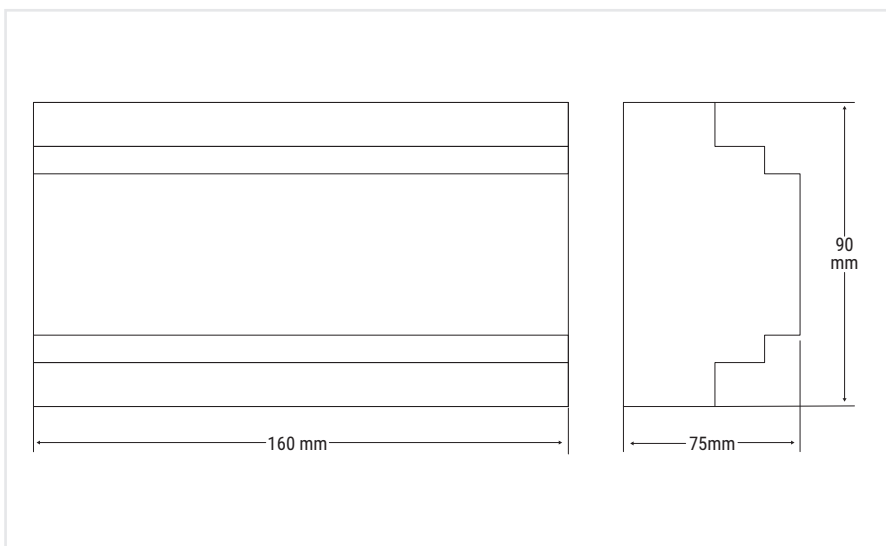

## FUNCTIONS

- Setting of the dimmer level
- Definition of operating mode (fixed brightness at a set value or automatic dimming)
- Diagnostics
- Measurement of energy consumption and energy saved
- Creation of lighting scenarios
- Timed switching on/off of lamp groups
- Configuration of the lighting system
- Management of all emergency system functions
- Synchronisation and timing of test functions
- Emergency inhibition/enabling
- Detailed error management
- Alternating (even/odd) autonomy tests to keep 50% of the system always on, even during tests

## LOW POWER RADIO COMMUNICATIONS BASED ON SPREAD-SPECTRUM TECHNOLOGY UNLIMITED RADIO RANGE

The radio waves used by the Logica FM system are very low power to avoid any kind of interference and electromagnetic pollution. The power involved in radio communication is less than one hundredth of that emitted by a normal mobile phone. The signal transmitted by the Control Unit is received by the first luminaire in the "route" memorised during the control unit

start-up; each luminaire, equipped with a radio transceiver and an amplifier, receives and transmits the signal to the next appliance in the memorised "route".

All products in this range comply with the standards in the European Recommendation ERC/REC 70-03.

	Order Code	Description	Number of luminaires	Number of DIN rail modules	Weight Kg	Packaging Single/Multi pack
<b>LGFM</b>	21102	SD LOGIC CONTROL UNIT (SIM included)	996	9	0.6	1

## System modules



Expansion modules, to be integrated inside the luminaires, to upgrade to a specific centralised control system allowing connection to the relevant control units (**SD LGFM, LGFM, LG**) or to other centralised systems(**DALI**).

### LG MODULE

It allows the expansion of the device for dialogue, via the Logica BUS, with the **Logica LG Control Unit**.

### LGFM MODULE

High-frequency transceiver module for spread spectrum radio transmission, which allows luminaires to be radio connected to the **Logica SD LGFM and Logica Connect LGFM control units**.

### DALI MODULE

It allows luminaire expansion for dialogue via **DALI BUS** with various control units equipped with DALI protocol data transmission.

	Order Code	Description	IP protection rating	Packaging Single/Multi pack
<b>LG</b>	15036	LG MODULE	IP20	1
<b>LGFM</b>	15037	LGFM MODULE	IP20	1
	15047*	IP65 LGFM MODULE	IP65	1
	19375**	LGFM INVERTER MODULE	IP20	1
<b>DALI</b>	15038	DALI MODULE	IP20	1

\* To be combined with LungaLargaLuce Extreme (Code 19370)

\*\* To be combined with INVERTER (19355L, 19390, 19391), STEEL (Cod.15030,15032), DOT (Order 19712)

# Inibit remote control

emergency

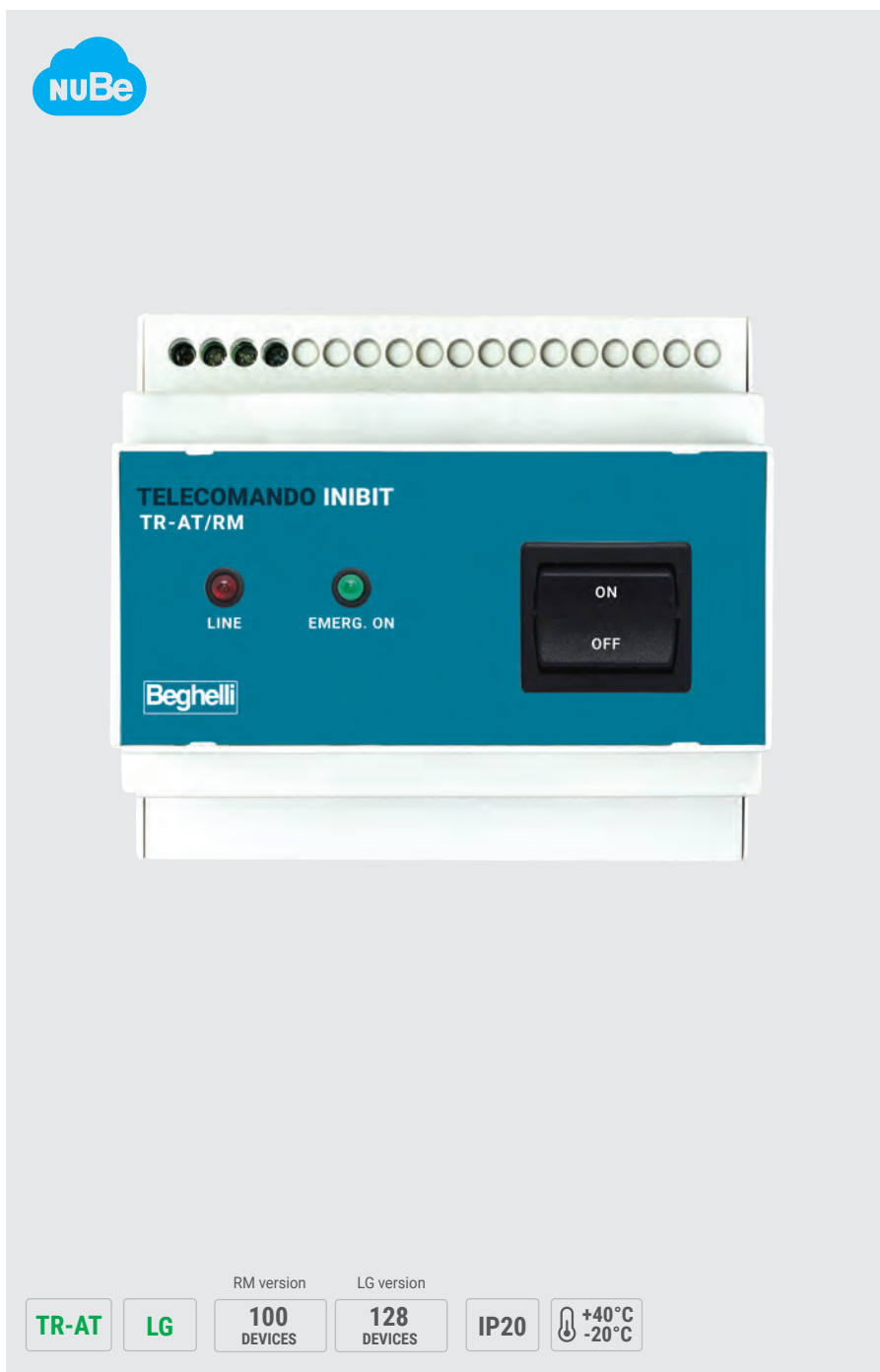

Inibit control unit for the centralised remote control of the inhibition of the emergency system (Rest Mode function). The connection is via a 2-wire BUS. Available for LG version (4 DIN modules) and RM version (6 DIN modules)

## Applications

Industry, services

## Characteristics

Power supply 230VAC  $\pm 10\%$ , 50-60Hz

**Mounting** 4/6 DIN rail modules

**Equipment** anti-blackout battery

**Managed luminaires** up to 128 devices in the LG version, up to 100 devices in the RM version (split over 2 lines 50+50)

## Connection interface

WiFi - AccesPoint (AP) mode and Client (STA) mode, Bluetooth (not enabled)

## Management software

B.connect App, NuBe (LG version only)

**Compliance** EN60950-1, EN62034, EN50172, 2014/53/EU

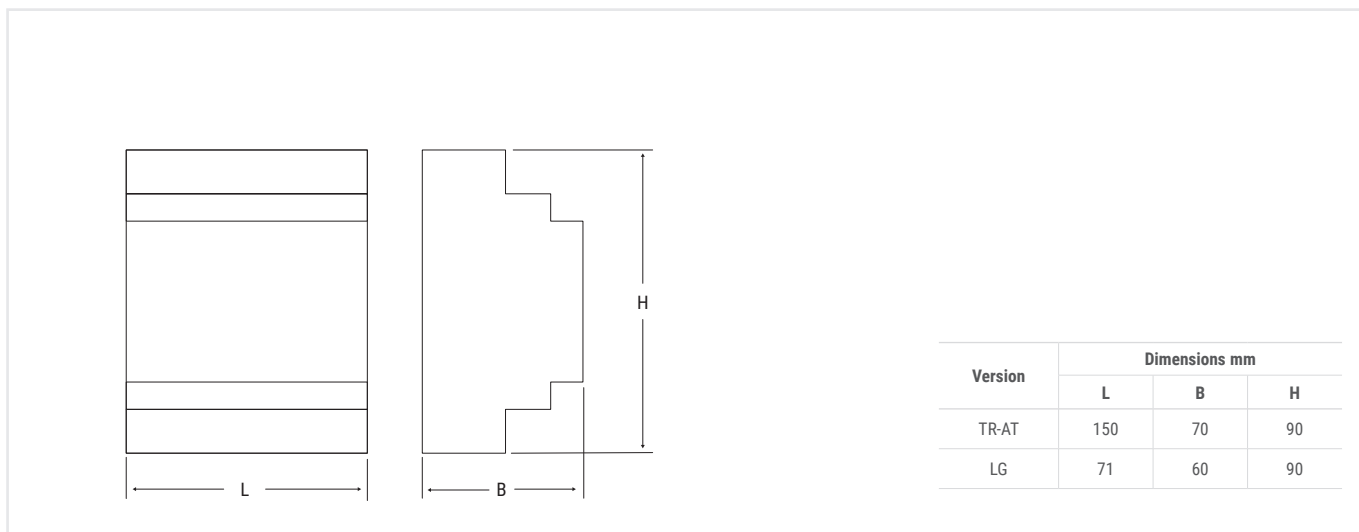

Version	Dimensions mm		
	L	B	H
TR-AT	150	70	90
LG	71	60	90



RM INIBIT REMOTE CONTROL



LG INIBIT REMOTE CONTROL

	Order Code	Description	Number of luminaires	Autonomy	Battery	Mounting	Weight Kg	Packaging Single/Multi pack
TR-AT	2730	973	100	500 activations	Nicd 6V 0.5Ah	DIN rail	0.4	1/6
LG	12101	LG LOGICA REMOTE CONTROL	128	500 activations	NiCd 7.2V 0.75Ah	DIN rail	0.5	1

# Logica 230

emergency



Centralised power supply for emergency lighting with diagnostic functions and automatic functional and autonomy tests. Each luminaire performs diagnostics in accordance with UNI 11222 and communicates with the control unit using the power lines to exchange information. A technology by which the Control Unit sends an encrypted transmission to the luminaire to which it is addressed on the power supply lines dedicated to the luminaires, with no possibility of error.



The system allows the composition of a mixed LG230 and LG24 system. It is also possible to connect luminaires, already used for ordinary lighting, in emergency mode by inserting the specific Lamp Module.

**Compliance** EN50171, 2014/30/EU, 2014/35/EU, EN50172, EN62040-1-1, EN62040-2

## CONTROL UNITS AND SUB-UNITS

The LG230 Control Unit is available in many standard configurations ranging from the smallest ST5, to the largest ST24. Furthermore, in order not to lose the great versatility of the system, customised compositions can be made following a specific modular coding that allows you to create your own tailor-made system. Each Control Unit is then integrated into a metal cabinet that contains all the components required for the system. In the case of complex systems or systems divided into different zones, it is advisable to split up the system using the appropriate sub-units, which are also available in different sizes according to the number of lamps and lines to be supplied. In systems with high power, a second cabinet containing the battery pack is provided. The batteries used are 216 VDC (18x12V) sets with an average lifespan of more than 10 years at 20°C.

### LG230 CONTROL UNITS



### LG230 CONTROL SUB-UNITS





## FUNCTIONS

- Control and monitoring of emergency luminaires on the same line, but with a different mode of operation:
- SE mode with switchover to SA mode via external control
- SE mode with selective activation of the emergency function by external monitoring modules
- Selective activation of the emergency function via auxiliary inputs
- Automatic recognition of control lines and modules for the installed luminaires
- Individual monitoring of 32 luminaires per line
- Automatic execution of functional and autonomy tests
- Automatic reporting of tests performed.
- Event logging for two years (LOG-BOOK)

## MODULARITY AND SAFETY

Each LG230 Control Unit has a variable number of lines. Each line can control up to 32 luminaires. Each output module can handle 1 (1380W), 2 (2 x 690W) or 4 (4 x 345W) lines depending on the model. The total number of luminaires per output module must not exceed the total power of the line.

The possibility of splitting the emergency lighting supply over

several outputs, all individually protected, introduces a new concept of safety and regulatory compliance that is far superior to the standards of centralised emergency systems.

### SUPER SAFETY WITH THE DRM MODULE

# DRM

**AUTORIPARA**

DRM is an optional module made with Titanium batteries, which can be integrated into LG230 luminaires to create a disaster-proof system. If the structure containing the lines of the emergency power supply unit feeding the emergency luminaires fails, the DRM will intervene to ensure emergency lighting in all cases.

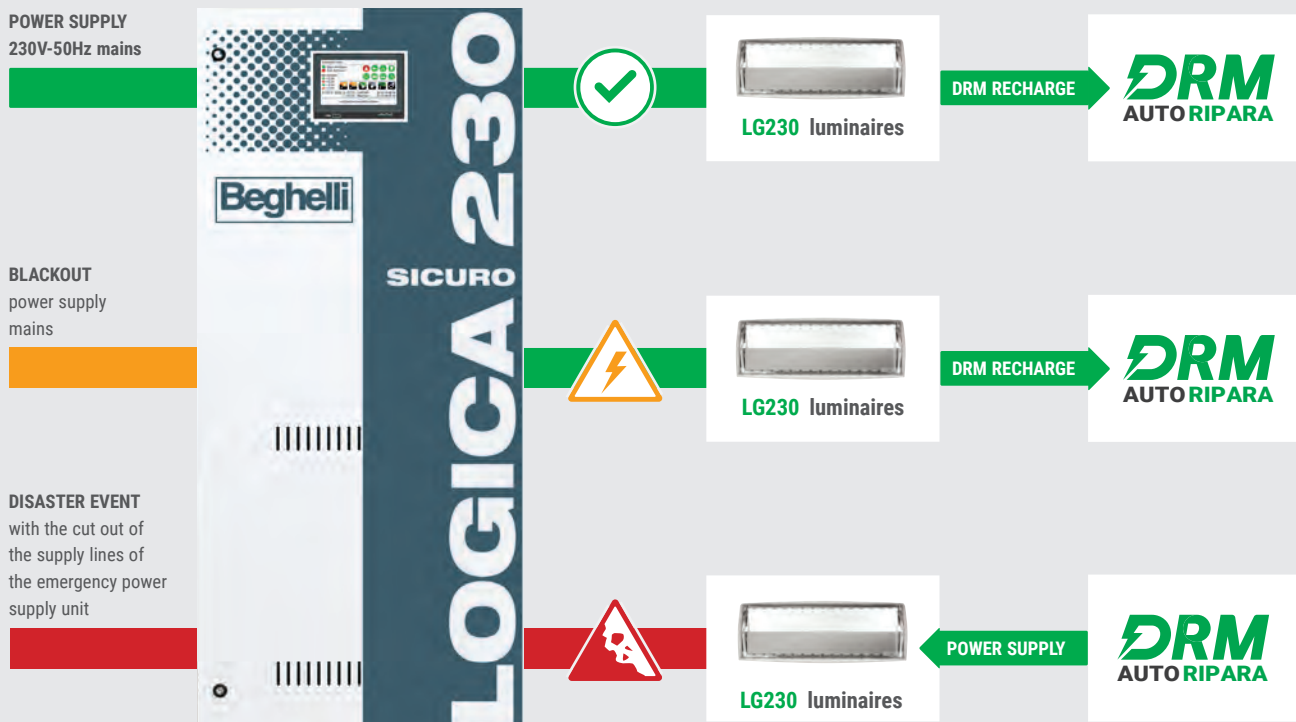

NEXT >

# Logica 230

emergency

## LG230 - LG24: EXPRESSION OF PURE FUNCTIONALITY

LOGICA 230/24 is a centralised power supply for emergency lighting with diagnostic functions and automatic functional and autonomy tests. The great versatility of the system allows composing a mixed system consisting of 230V modules and 24V modules using LOGICA 230 and LOGICA 24 also in dynamic mode. In addition, it is possible to connect luminaires already used for ordinary lighting as emergency luminaires, by simply inserting the specific Lamp Module, and it is always possible to integrate LOGICA 230/24 into a BMS system (Building Management System). Each luminaire can carry out the diagnostics required by the

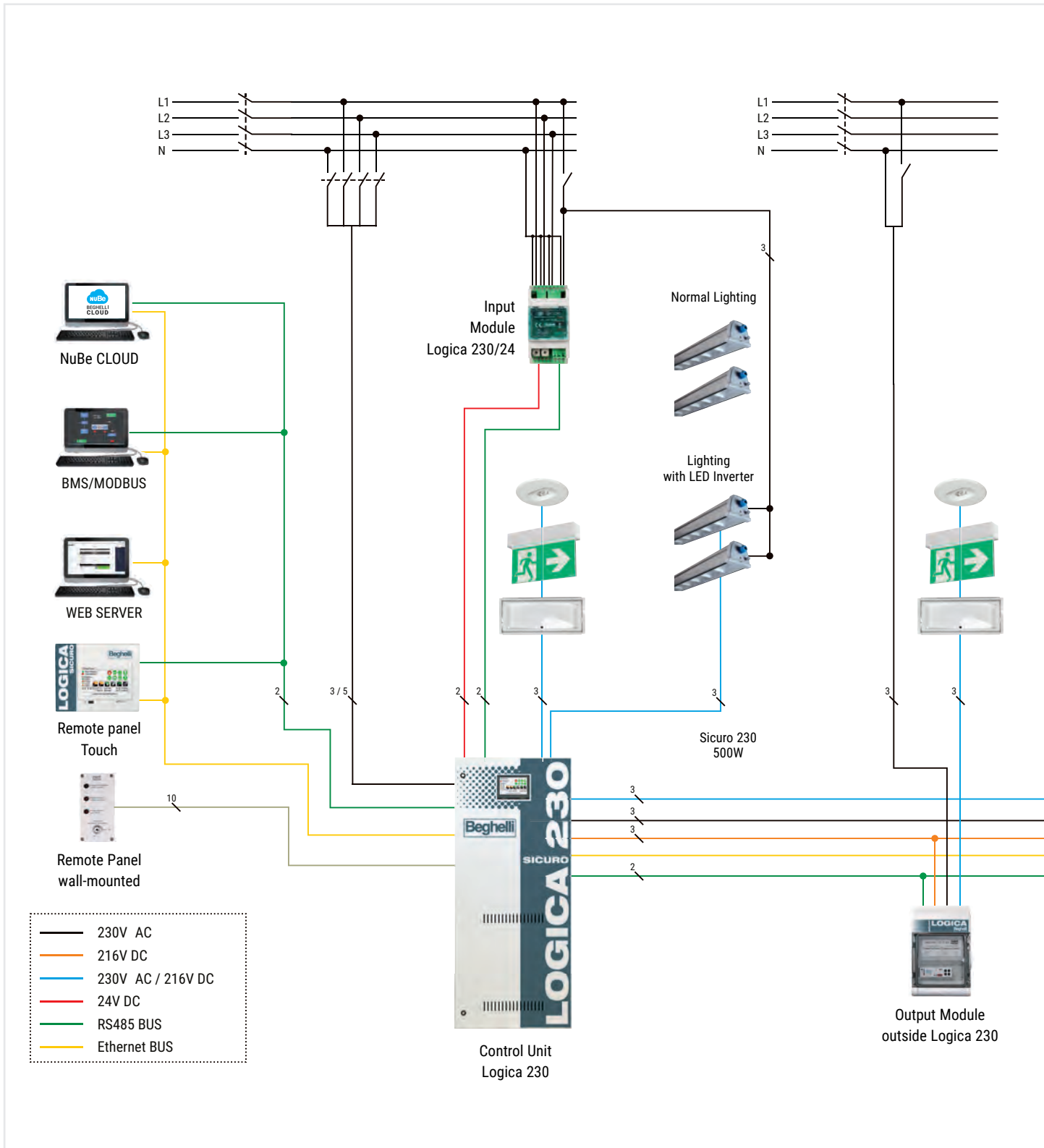

UNI 11222 standard by communicating individually with the control unit using the power supply lines for information exchange by means of the power-line communication technology: the Control Unit sends an encoded digital transmission on the power supply lines dedicated to the luminaires, which transmission is only received by the luminaire to which it is addressed. This technology limits the number of connections and installation cables with obvious savings in material and labour.

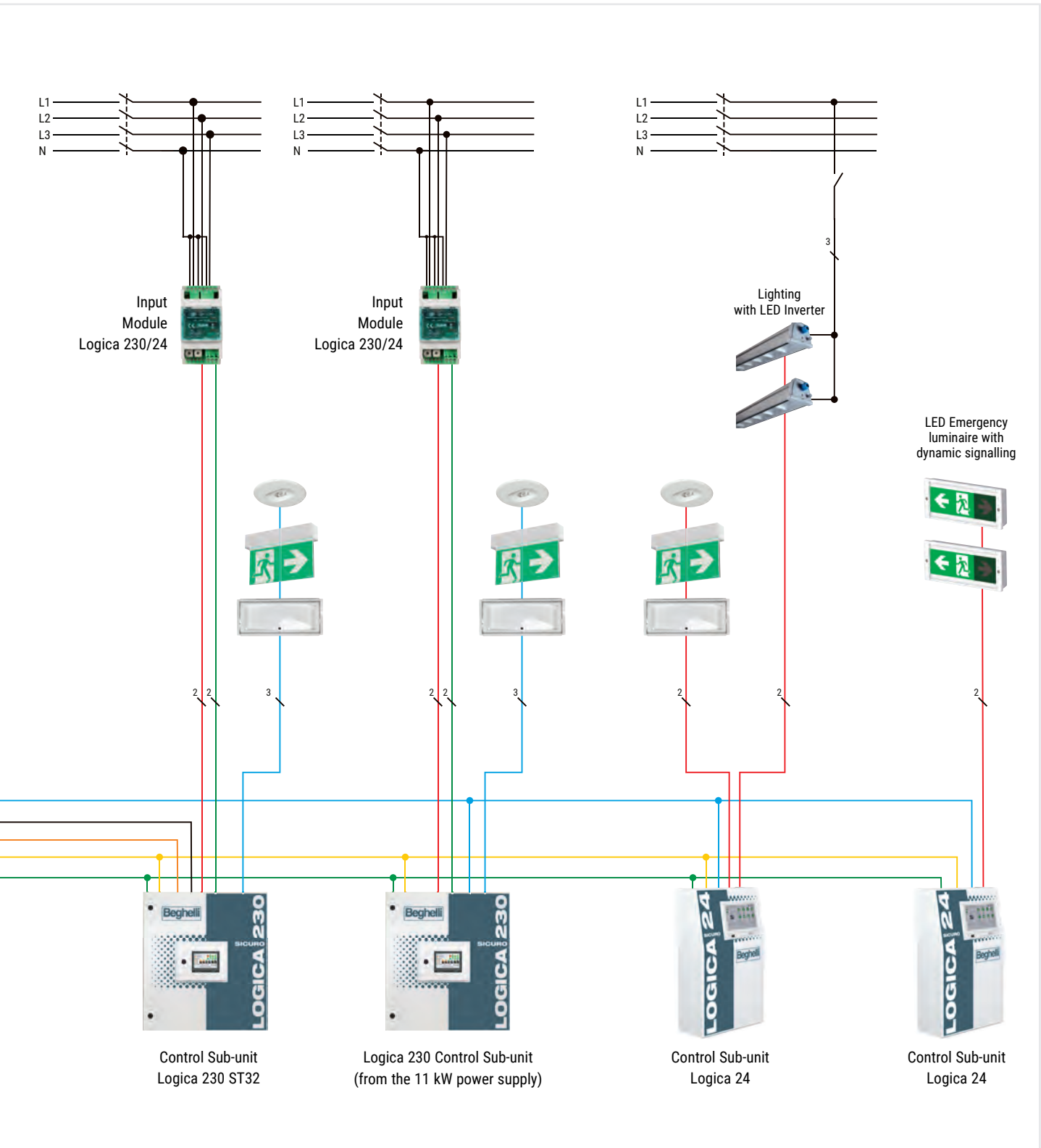

# Logica 230

emergency

## SELECTION AND CODING OF THE LG230 CONTROL UNIT AND SUB-UNIT

In order not to lose the advantage of the system's great modularity, all compositions that go beyond the standard will have a new coding that, starting from the basic order code, will identify all additional modules:



### LG230 Control Unit extended encoding

The first step is to identify the basic LG230 Control Unit that is already encoded and to integrate it with the modules, accessories and sub-units required for the system.

- number of Output Modules with 1, 2 or 4 circuits
- number of 230V Input Modules or potential-free contacts
- number of external Sub-units or Output Modules derived from the Main Control Unit, if any, in the system

Order Code of the Control Unit	Total number	Total number	Total number	Total number
17 ---	-1 / -2 / -4	<b>U</b> ---	<b>I / IC</b> ---	<b>/ K</b> --- <b>S</b> ---

**U** = Output Modules:

- **1U** = 1X32 (Code 17233)
- **2U** = 2X32 (Code 17232)
- **4U** = 4X32 (Code 17234)

**I** = Input Modules      **I** = 230V (Code 17230)  
**IC** = 24V (Code 17231)

**K** = External Output Modules (AK)

**S** = Outputs for sub-units



### LG230 Control Sub-unit extended encoding

As with the control units, the code composition involves the choice of a base code Sub-unit to be integrated with the necessary modules

- number of Output Modules with 1, 2 or 4 circuits
- number of 230V Input Modules

Order Code of the Control Unit	Total number	Total number	Total number
17 ---	-1 / -2 / -4	<b>U</b> ---	<b>I / IC</b> --- <b>/ K</b> ---

**U** = Output Modules:

- **1U** = 1X32 (Code 17233)
- **2U** = 2X32 (Code 17232)
- **4U** = 4X32 (Code 17234)

**I** = Input Modules      **I** = 230V (Code 17230)  
**IC** = 24V (Code 17231)

**K** = External Output Modules (AK)

## ST5 LG230 CONTROL UNIT



The LOGICA 230 ST5 control unit (5 slots) is integrated into a metal cabinet that contains all system components and battery packs. Each control unit has a variable number of Output and Input Modules, depending on the model. Each output module is divided into 1, 2 or 4 lines, each capable of controlling up to 32 luminaires for a maximum of 1380W for 1x version, 690W for 2x version, 345W for 4x version each line. The LOGICA 230 ST5 Control Unit has a 7" graphic touch screen display mounted on the door and output modules with 19" housings, the batteries are housed directly in the lower part of the Control Unit cabinet.

	Order Code	W	Description	Autonomy h	Modules OUT*	Modules IN**	Number of cabinets Battery	Battery	Power W		Weight Kg
									Nominal***	Max.	
LG230	17601	800	ST5 S230 CONTROL UNIT 7Ah 1P	1h	0	0	-	18 x (12 V 7 Ah)	950	760	107
	17602	500	ST5 S230 CONTROL UNIT 7Ah 2P	2h	0	0	-	18 x (12 V 7 Ah)	561	449	107
	17603	300	ST5 S230 CONTROL UNIT 7Ah 3P	3h	0	0	-	18 x (12 V 7 Ah)	388	310	107
	17604	1500	ST5 S230 CONTROL UNIT 12Ah 1P	1h	0	0	-	18 x (12 V 12 Ah)	1749	1399	138
	17605	800	ST5 S230 CONTROL UNIT 12Ah 2P	2h	0	0	-	18 x (12 V 12 Ah)	972	778	138
	17606	600	ST5 S230 CONTROL UNIT 12Ah 3P	3h	0	0	-	18 x (12 V 12 Ah)	712	570	138

\* Modules expandable up to 5 slots - \*\* Built-in IN modules expandable up to 2 / External IN modules expandable up to 96 - \*\*\* 20° environment

## STX5 LG230 CONTROL UNIT



The LOGICA 230 ST5 Control Unit (5 slots) is integrated into a metal cabinet that contains all system components and battery packs. Each control unit has a variable number of Output and Input Modules, depending on system requirements, max. 5 slots. Each output module is divided into 1, 2 or 4 lines, each capable of controlling up to 32 luminaires for a maximum of 1380W for 1x version, 690W for 2x version, 345W for 4x version each line. The LOGICA 230 Mini Control Unit has a 7" graphic touch screen display mounted on the door and output modules with 19" housings, the batteries are housed directly in the lower part of the Control Unit cabinet.

	Order Code	W	Description	Autonomy h	Modules OUT*	Modules IN**	Number of cabinets Battery	Battery	Power W		Weight Kg
									Nominal***	Max.	
LG230	17610	1500	STX5 S230 CONTROL UNIT 12Ah 1P	1h	0	0	-	18 x (12 V 12 Ah)	1749	1399	161
	17611	800	STX5 S230 CONTROL UNIT 12Ah 2P	2h	0	0	-	18 x (12 V 12 Ah)	972	778	161
	17612	600	STX5 S230 CONTROL UNIT 12Ah 3P	3h	0	0	-	18 x (12 V 12 Ah)	712	570	161
	17613	2000	STX5 S230 CONTROL UNIT 18Ah 1P	1h	0	0	-	18 x (12 V 18 Ah)	2562	2050	187
	17614	1200	STX5 S230 CONTROL UNIT 18Ah 2P	2h	0	0	-	18 x (12 V 18 Ah)	1466	1173	187
	17615	900	STX5 S230 CONTROL UNIT 18Ah 3P	3h	0	0	-	18 x (12 V 18 Ah)	1065	852	187
	17616	3500	STX5 S230 CONTROL UNIT 28Ah 1P	1h	0	0	-	18 x (12 V 28 Ah)	4481	3585	260
	17617	2000	STX5 S230 CONTROL UNIT 28Ah 2P	2h	0	0	-	18 x (12 V 28 Ah)	2533	2026	260
	17618	1500	STX5 S230 CONTROL UNIT 28Ah 3P	3h	0	0	-	18 x (12 V 28 Ah)	1820	1456	260

\* Modules expandable up to 5 slots - \*\* Built-in IN modules expandable up to 2 / External IN modules expandable up to 96 - \*\*\* 20° environment

NEXT >

# Logica 230

emergency

## ST13 LG230 CONTROL UNIT



The LOGICA 230 ST13 Control Unit (13 slots) is integrated into a metal cabinet that contains all system components and battery packs. Each control unit has a variable number of Output and Input Modules, depending on system requirements, max. 13 slots. Each output module is divided into 1, 2 or 4 lines, each capable of controlling up to 32 luminaires for a maximum of 1380W for 1x version, 690W for 2x version, 345W for 4x version each line. The LOGICA 230 ST13 Control Unit has a 7" graphic touch screen display mounted on the door and output modules with 19" housings, the batteries are housed directly in the lower part of the Control Unit cabinet.

	Order Code	W	Description	Autonomy h	Modules OUT*	Modules IN**	Number of cabinets Battery	Battery	Power W		Weight Kg
									Nominal***	Max.	
LG230	17620	2000	S230 CONTROL UNIT 18Ah 1P	1h	0	0	-	18 x (12 V 18 Ah)	2562	2050	253
	17621	1200	S230 CONTROL UNIT 18Ah 2P	2h	0	0	-	18 x (12 V 18 Ah)	1466	1173	253
	17622	900	S230 CONTROL UNIT 18Ah 3P	3h	0	0	-	18 x (12 V 18 Ah)	1065	852	253
	17623	3500	S230 CONTROL UNIT 28Ah 1P	1h	0	0	-	18 x (12 V 28 Ah)	4481	3585	326
	17624	2000	S230 CONTROL UNIT 28Ah 2P	2h	0	0	-	18 x (12 V 28 Ah)	2533	2026	326
	17625	1500	S230 CONTROL UNIT 28Ah 3P	3h	0	0	-	18 x (12 V 28 Ah)	1820	1456	326
	17626	4500	S230 CONTROL UNIT 33Ah 1P	1h	0	0	-	18 x (12 V 33 Ah)	5404	4323	351
	17627	2500	S230 CONTROL UNIT 33Ah 2P	2h	0	0	-	18 x (12 V 33 Ah)	3019	2415	351
	17628	1800	S230 CONTROL UNIT 33Ah 3P	3h	0	0	-	18 x (12 V 33 Ah)	2161	1729	351
	17629	5500	S230 CONTROL UNIT 44Ah 1P	1h	0	0	-	18 x (12 V 44 Ah)	6710	5368	406
	17630	3200	S230 CONTROL UNIT 44Ah 2P	2h	0	0	-	18 x (12 V 44 Ah)	3846	3077	406
	17631	2200	S230 CONTROL UNIT 44Ah 3P	3h	0	0	-	18 x (12 V 44 Ah)	2776	2221	406
	17632	7000	S230 CONTROL UNIT 55Ah 1P	1h	0	0	-	18 x (12 V 55 Ah)	8609	6887	471
	17633	4000	S230 CONTROL UNIT 55Ah 2P	2h	0	0	-	18 x (12 V 55 Ah)	4980	3984	471
	17634	3000	S230 CONTROL UNIT 55Ah 3P	3h	0	0	-	18 x (12 V 55 Ah)	3561	2849	471
	17635	9200	S230 CONTROL UNIT 70Ah 1P	1h	0	0	-	18 x (12 V 70 Ah)	11359	9087	601
	17636	5500	S230 CONTROL UNIT 70Ah 2P	2h	0	0	-	18 x (12 V 70 Ah)	6675	5340	601
	17637	4000	S230 CONTROL UNIT 70Ah 3P	3h	0	0	-	18 x (12 V 70 Ah)	4838	3870	601
	17638	10800	S230 CONTROL UNIT 80Ah 1P	1h	0	0	-	18 x (12 V 80 Ah)	13245	10596	631
	17639	6100	S230 CONTROL UNIT 80Ah 2P	2h	0	0	-	18 x (12 V 80 Ah)	7461	5969	631
17640	4400	S230 CONTROL UNIT 80Ah 3P	3h	0	0	-	18 x (12 V 80 Ah)	5370	4296	631	
17641	12800	S230 CONTROL UNIT 100Ah 1P	1h	0	0	-	18 x (12 V 100 Ah)	15673	12538	696	
17642	7400	S230 CONTROL UNIT 100Ah 2P	2h	0	0	-	18 x (12 V 100 Ah)	9006	7205	696	
17643	5400	S230 CONTROL UNIT 100Ah 3P	3h	0	0	-	18 x (12 V 100 Ah)	6549	5239	696	
17644	13800	S230 CONTROL UNIT 110Ah 1P	1h	0	0	-	18 x (12 V 110 Ah)	16903	13522	751	
17645	8000	S230 CONTROL UNIT 110Ah 2P	2h	0	0	-	18 x (12 V 110 Ah)	9854	7883	751	
17646	6000	S230 CONTROL UNIT 110Ah 3P	3h	0	0	-	18 x (12 V 110 Ah)	7191	5753	751	

\* Modules expandable up to 13 slots - \*\* Built-in IN modules expandable up to 4 / External IN modules expandable up to 96 - \*\*\* 20° environment



## ST24 LG230 CONTROL UNIT



The ST24 Control Unit (24 slots) is integrated into a metal cabinet that contains all system components. A second cabinet containing the battery pack is provided. Each Control Unit has a variable number of Output and Input Modules, depending on system requirements, max. 24 slots. Each output module is divided into 1, 2 or 4 lines, each capable of controlling up to 32 luminaires for a maximum of 1380W for 1x version, 690W for 2x version, 345W for 4x version each line.

The ST24 control unit has a 7" graphic touch screen display mounted on the door and output modules with 19" housings, the batteries are housed in a separate cabinet.

	Order Code	W	Description	Autonomy h	Modules OUT*	Modules IN**	Number of cabinets Battery	Battery	Power W		Weight Kg
									Nominal***	Max.	
LG230	17650	9200	ST24 S230 CONTROL UNIT 70Ah 1P	1	0	0	1	18 x (12 V 70 Ah)	11359	9087	783
	17651	5500	ST24 S230 CONTROL UNIT 70Ah 2P	2	0	0	1	18 x (12 V 70 Ah)	6675	5340	783
	17652	4000	ST24 S230 CONTROL UNIT 70Ah 3P	3	0	0	1	18 x (12 V 70 Ah)	4838	3870	783
	17653	10800	ST24 S230 CONTROL UNIT 80Ah 1P	1	0	0	1	18 x (12 V 80 Ah)	13245	10596	813
	17654	6100	ST24 S230 CONTROL UNIT 80Ah 2P	2	0	0	1	18 x (12 V 80 Ah)	7461	5969	813
	17655	4400	ST24 S230 CONTROL UNIT 80Ah 3P	3	0	0	1	18 x (12 V 80 Ah)	5370	4296	813
	17656	12800	ST24 S230 CONTROL UNIT 100Ah 1P	1	0	0	1	18 x (12 V 100 Ah)	15673	12538	878
	17657	7400	ST24 S230 CONTROL UNIT 100Ah 2P	2	0	0	1	18 x (12 V 100 Ah)	9006	7205	878
	17658	5400	ST24 S230 CONTROL UNIT 100Ah 3P	3	0	0	1	18 x (12 V 100 Ah)	6549	5239	878
	17659	13800	ST24 S230 CONTROL UNIT 110Ah 1P	1	0	0	1	18 x (12 V 110 Ah)	16903	13522	933
	17660	8000	ST24 S230 CONTROL UNIT 110Ah 2P	2	0	0	1	18 x (12 V 110 Ah)	9854	7883	933
	17661	5900	ST24 S230 CONTROL UNIT 110Ah 3P	3	0	0	1	18 x (12 V 110 Ah)	7191	5753	933
	17662	14800	ST24 S230 CONTROL UNIT 120Ah 1P	1	0	0	1	18 x (12 V 120 Ah)	18117	14494	1018
	17663	8600	ST24 S230 CONTROL UNIT 120Ah 2P	2	0	0	1	18 x (12 V 120 Ah)	10522	8418	1018
	17664	6300	ST24 S230 CONTROL UNIT 120Ah 3P	3	0	0	1	18 x (12 V 120 Ah)	7719	6175	1018
	17665	18900	ST24 S230 CONTROL UNIT 135Ah 1P	1	0	0	1	18 x (12 V 135 Ah)	23156	18525	1128
	17666	11100	ST24 S230 CONTROL UNIT 135Ah 2P	2	0	0	1	18 x (12 V 135 Ah)	13563	10850	1128
	17667	7900	ST24 S230 CONTROL UNIT 135Ah 3P	3	0	0	1	18 x (12 V 135 Ah)	9677	7742	1128
	17668	19400	ST24 S230 CONTROL UNIT 150Ah 1P	1	0	0	1	18 x (12 V 150 Ah)	23693	18954	1163
	17669	11200	ST24 S230 CONTROL UNIT 150Ah 2P	2	0	0	1	18 x (12 V 150 Ah)	13668	10934	1163
17670	8000	ST24 S230 CONTROL UNIT 150Ah 3P	3	0	0	1	18 x (12 V 150 Ah)	9819	7855	1163	
17671	24700	ST24 S230 CONTROL UNIT 200Ah 1P	1	0	0	2	18 x (12 V 200 Ah)	30243	24194	1694	
17672	14800	ST24 S230 CONTROL UNIT 200Ah 2P	2	0	0	2	18 x (12 V 200 Ah)	18101	14481	1694	
17673	10800	ST24 S230 CONTROL UNIT 200Ah 3P	3	0	0	2	18 x (12 V 200 Ah)	13225	10580	1694	
17674	29400	ST24 S230 CONTROL UNIT 230Ah 1P	1	0	0	2	18 x (12 V 230 Ah)	36059	28847	1844	
17675	17300	ST24 S230 CONTROL UNIT 230Ah 2P	2	0	0	2	18 x (12 V 230 Ah)	21228	16982	1844	
17676	12500	ST24 S230 CONTROL UNIT 230Ah 3P	3	0	0	2	18 x (12 V 230 Ah)	15225	12180	1844	

\* Modules expandable up to 24 slots - \*\* Built-in IN modules expandable up to 8 / External IN modules expandable up to 96 - \*\*\* 20° environment

# Logica 230

emergency

## SUB-UNITS



LG230

IP54

350x600x570mm

### ST8 LG230 SUB-UNIT

Each output module is divided into 1, 2 or 4 lines, each capable of controlling up to 32 luminaires for a maximum of 1380W for 1x version, 690W for 2x version, 345W for 4x version each line.

The ST8 sub-unit incorporates a 7" graphic touch screen display.

Order Code	Description	Modules OUT*	Modules IN**	Weight Kg
17680	ST8 S230 SUB-UNIT	0	0	35

\* Modules expandable up to 8 slots - \*\* Built-in IN modules expandable up to 2 / External IN modules expandable up to 96



LG230

IP54

400x800x890mm

### ST16 LG230 SUB-UNIT

Each output module is divided into 1, 2 or 4 lines, each capable of controlling up to 32 luminaires for a maximum of 1380W for 1x version, 690W for 2x version, 345W for 4x version each line.

The ST16 Sub-unit incorporates a 7" graphic touch screen display.

Order Code	Description	Modules OUT*	Modules IN**	Weight Kg
17681	ST16 S230 SUB-UNIT	0	0	66

\* Modules expandable up to 16 slots - \*\* Built-in IN modules expandable up to 4 / External IN modules expandable up to 96



LG230

IP54

600x800x2000mm

### ST32 LG230 SUB-UNIT

Each output module is divided into 1, 2 or 4 lines, each capable of controlling up to 32 luminaires for a maximum of 1380W for 1x version, 690W for 2x version, 345W for 4x version each line.

The ST32 Sub-unit incorporates a 7" graphic touch screen display.

Order Code	Description	Modules OUT*	Modules IN**	Weight Kg
17682	ST32 S230 SUB-UNIT	0	0	163

\* Modules expandable up to 32 slots - \*\* Built-in IN modules expandable up to 8 / External IN modules expandable up to 96



LG24

IP20

400x316x144mm

### S24 LG24 SUB-UNIT

Multi-purpose sub-unit for the LG24 system, but it can also be connected to an LG230 Control Unit. Each output module is divided into 1, 2 or 4 lines, each capable of controlling up to 32 x 24V luminaires.

The S24 Sub-unit incorporates a 7" graphic touch screen display.

Order Code	Description	Modules OUT	Modules IN*	Weight Kg
17064	S24 SUB-UNIT	1 (4x32)	-	16

\* External IN modules expandable up to 96

## SYSTEM COMPONENTS



### LG230 DRM MODULE

The DRM module recharges a new generation LiTO (Lithium titanate battery) with a very long life, when the system is in normal operation.

In the event of a disaster that cuts the power cables (e.g., an earthquake), the battery, via the DRM module, provides the lamp with the energy to switch on the emergency light



Order Code	Description	Battery	Autonomy h	Recharging time h	LED lm*	Weight Kg
17236	DRM S230 MODULE + 1 LTO BATTERY	LTO 4.8V 0.5 Ah	1.5	7	110	
RA09	ADDITIONAL LTO BATTERY	LTO 4.8V 0.5 Ah	3	14	-	



### EXTERNAL OUTPUT MODULE

The external output modules are integrated in a plastic cabinet that contains all system components, has a control panel with a large display, and cable entry from above.

Output module: 2 or 4 lines for max. 32 luminaires per line, permanent or non-permanent mode on the same line, power per line: 400W max., voltage/current per line: 230 V / 1.75A)

Order Code	W	Description	Modules OUT*	No. of luminaires Connectable	Weight Kg
17685	400	S230 2X32 EXT. OUTPUT MODULE	1(2x32)	64	37
17686	2X400	S230 2+2X32 EXT. OUTPUT MODULE	2 (2x32)	128	40

\* Number of output modules supplied 2x32 (300W max. per line)

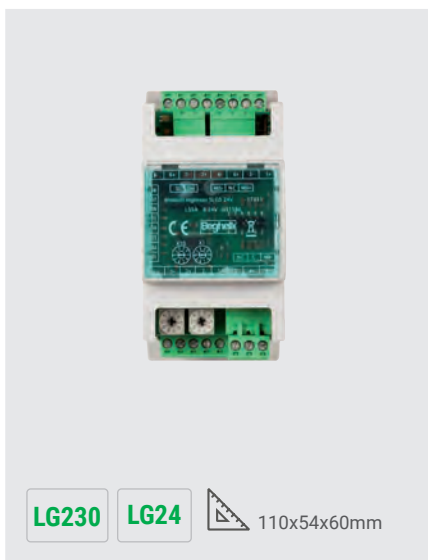

### LG230 - LG24 INPUT MODULES

Ordinary mains monitoring module. It allows a selective activation of parts of the system.

8 inputs - Relay output - DIN module mounting

**LG230 module:** 230V mains check on inputs  
Three-phase sensor on inputs 1,2,3

**LG24 module:** Check of isolated changeover contacts

Order Code	Description	Weight Kg
17230	S230 S24 230V DIN INPUT MODULE	0.2
17231	S230 S24 24V DIN INPUT MODULE	0.2

NEXT >

# Logica 230

emergency

## SYSTEM COMPONENTS



LG230

IP20



152x32x24mm

### LG230 6-12W LED INVERTER

Inverter module for LED luminaires, consisting of two parts, the Driver LED 12W Sicuro 230V and the Switch Module INV Sicuro 230V

- Driver output voltage from 2 to 55V.
- Management of LED emergency luminaires
- Housing material: polycarbonate

Order Code	Description	Weight Kg
17381	230V 12W LOGICA INVERTER	0.1



LG230

IP20



152x32x24mm

### 2.5-500W LAMP MODULE

Lamp monitoring and control module.

- Permanent mode (SA), non-permanent mode (SE).
- Switching on and off via local switch.
- Load: 2.5 W - 500 W
- Operating voltage: 198 - 254Vca / 50Hz
- Battery operating voltage: 176÷276VDC
- Housing material: polycarbonate
- Protection rating: II
- Maximum output inrush load: 50A per 250µs (3J)

Order Code	Description	Weight Kg
17382	SWITCH 500W LOGICA 230V	0.1



LG230

IP20



152x32x24mm

### DALI LAMP MODULE

Module for the management of luminaires for lighting and emergency lighting, equipped with a DALI electronic power supply unit, with anomaly reports.

- Individual monitoring with selective anomaly report
- SE or SA mode programmable from the Control Unit from the local LSSA or LSSA input module
- Selectable emergency lamp luminous flux
- Load: 2.5-4 W
- Operating voltage: 198Vca - 254Vca / 50 Hz
- Battery operating voltage: 176 VDC - 254VDC
- Housing material: polycarbonate

Order Code	Description	Weight Kg
17383	SWITCH LOGICA 230V DALI	0.1

# ACCESSORY



**LG230 OUTPUT MODULE**  
 Piloting of 1, 2 or 4 lines per luminaire. Each line can supply a load of 1380W for 1x version, 690W for 2x version, 345W for 4x version. Max. 32 luminaires per line.  
 Order Code **17232** (2X32)  
 Order Code **17233** (1X32) - Order Code **17234** (4X32)



**WALL-MOUNTED REMOTE PANEL**  
 Operation mode control for both LG230 and LG24 systems  
 Order Code **17207**



**NETWORK SENSOR**  
 Mains power monitoring module for normal lighting, activation of the output control in the event of a failure on the mains:  $U < 0.6 U_N$  per 0.5 s.  
 DS3 - UV 1-3 PHASE MONITORING  
 Order Code **17385**  
 Order Code **17206N**  
 Order Code **17226**



**RECESSED REMOTE PANEL**  
 Operation mode control for both LG230 and LG24 systems  
 Order Code **17208**



**REMOTE TOUCH SCREEN PANEL**  
 Control of up to 63 control units with multiple functions. It integrates a 7" graphic touch screen display  
 Order Code **17240**



**USB/RS485 CONVERTER**  
 Connection interface from PC to LG control units  
 Order Code **17235**



**BATTERY CONTROLLER**  
 Kit for 18 batteries  
 Order Code **17384**



**LS-UV MODULE**  
 Order Code **17237**

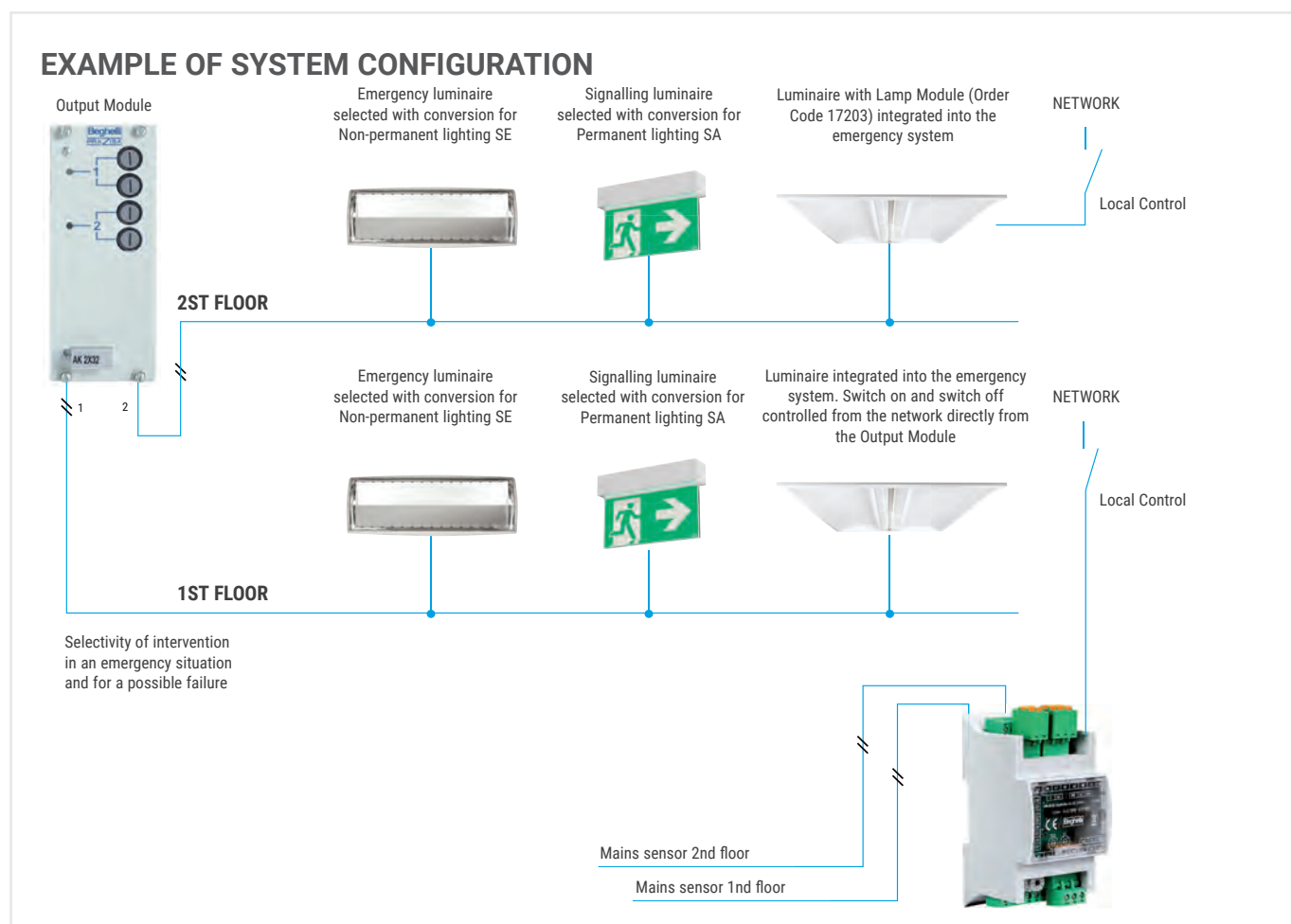

All the configurations shown in the diagram can be programmed simply from the control unit, without any changes to the system, using only the lamp power supply line, and can be reconfigured according to changing system requirements.

# Logica 24

emergency



A centralised power supply system that enables the management of emergency lighting and signalling lamps using a safety extra-low voltage. Diagnostic functions with automatic function and autonomy tests. According to DIN EN 50172, the system protection rating is class III. During emergency operation, a continuous 24VDC voltage is supplied. Each luminaire is assigned a specific unique address in self-learning. LOGICA 24 can also be integrated into a BMS (Building Management System) with the appropriate software.



By inserting the specific LED inverter, ordinary luminaires can be integrated into the emergency lighting system

**Compliance** EN50171, 2014/30/EU, 2014/35/EU, EN50172, EN62040-1-1, EN62040-2

## CONTROL UNITS

The LG24 Control Unit is available in 2 standard configurations that vary according to the number of lines (4 lines, 8 lines). Each control unit is with an adjustable autonomy from 1 h to 3 hrs, with decreasing powers.

### LG24 CONTROL UNITS





## FUNCTIONS

- Possibility of controlling and monitoring emergency luminaires on the same line, but with different operating modes:
  - SA functions: conversion of selected luminaires in permanent mode
  - For SA luminaires, 10-100% dimmer function;
  - SE function: conversion of selected luminaires to non-permanent mode
- Non-permanent mode with selective activation of the emergency function by external input modules in the event of a partial failure on the mains
- Automatic recognition of control lines and modules for the installed luminaires
- Individual monitoring of 32 luminaires per line
- Automatic execution of functional and autonomy tests
- Automatic reporting of tests performed.
- Event logging for two years (LOG-BOOK)

## INNOVATIONS IN THE LOGICA 24 SYSTEM

- Reduction in the number of circuits and wiring
- Reduction of the size of the control panel
- Reduction of installation costs
- Design simplification
- Increased flexibility both during and after installation
- Each module and each lamp is equipped with an identification code. No manual addressing required
- The LOGICA 24 system does not require incorrect or double addressing control. As a result, any time frame for solving a problem is eliminated

## SYSTEM SPLITTING

The LG24 system is particularly suitable for situations where splitting up the emergency system is advantageous. Each control unit is connected to a PC for supervision which, in turn, can be connected in the cloud with the NuBe Beghelli web portal.

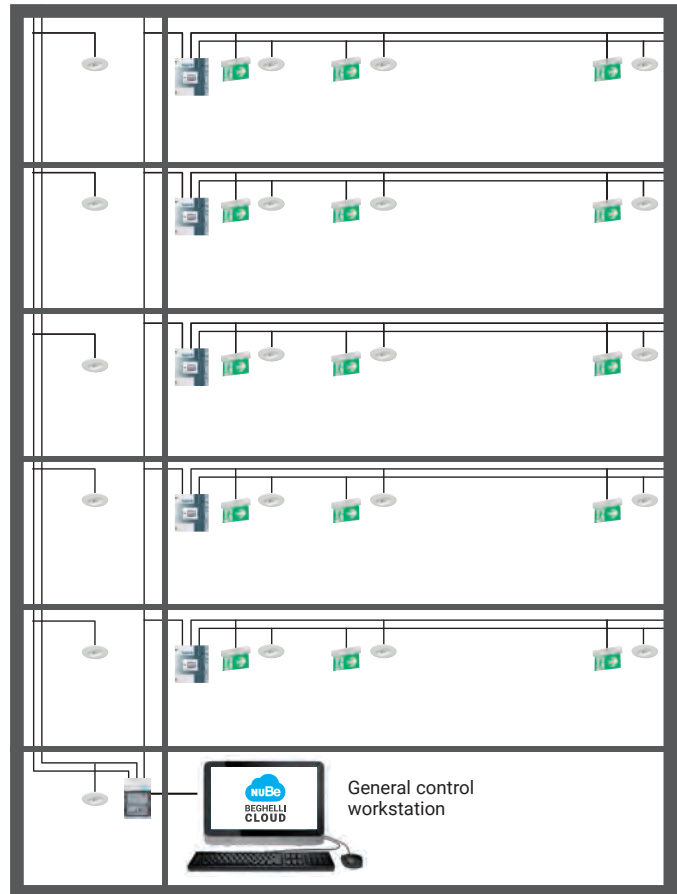

## 24V LOW-VOLTAGE OUTPUT MODULE



- Selective activation of the emergency function with emergency luminaires via the LOGICA 24 monitoring and control module
- Activation of the emergency function with normal lighting luminaires via the Inverter LOGICA 24 monitoring and control module
- Automatic addressing of the LOGICA 24 and Inverter LOGICA 24 modules via the ID code
- Permanent or non-permanent mode programmable per each luminaire
- Permanent or non-permanent mode on the same line
- Selective dimming (10 - 100%) per each luminaire in the permanent mode
- Selective switching (ON/OFF) per each luminaire in the permanent mode
- Selective switching (ON/OFF) per each luminaire in the non-permanent mode
- Self-diagnosis of all luminaires in a circuit with error indication for each luminaire

# Logica 24

emergency

## CENTRALISED LOW-VOLTAGE SYSTEMS

LOGICA 230/24 is a centralised power supply for emergency lighting with diagnostic functions and automatic functional and autonomy tests. The great versatility of the system allows composing a mixed system consisting of 230V modules and 24V modules using LOGICA 230 and LOGICA 24 also in dynamic mode. In addition, it is possible to connect luminaires already used for ordinary lighting as emergency luminaires, by simply inserting the specific Lamp Module, and it is always possible to integrate LOGICA 230/24 into a BMS system (Building Management System). Each luminaire can carry out the diagnostics required by the

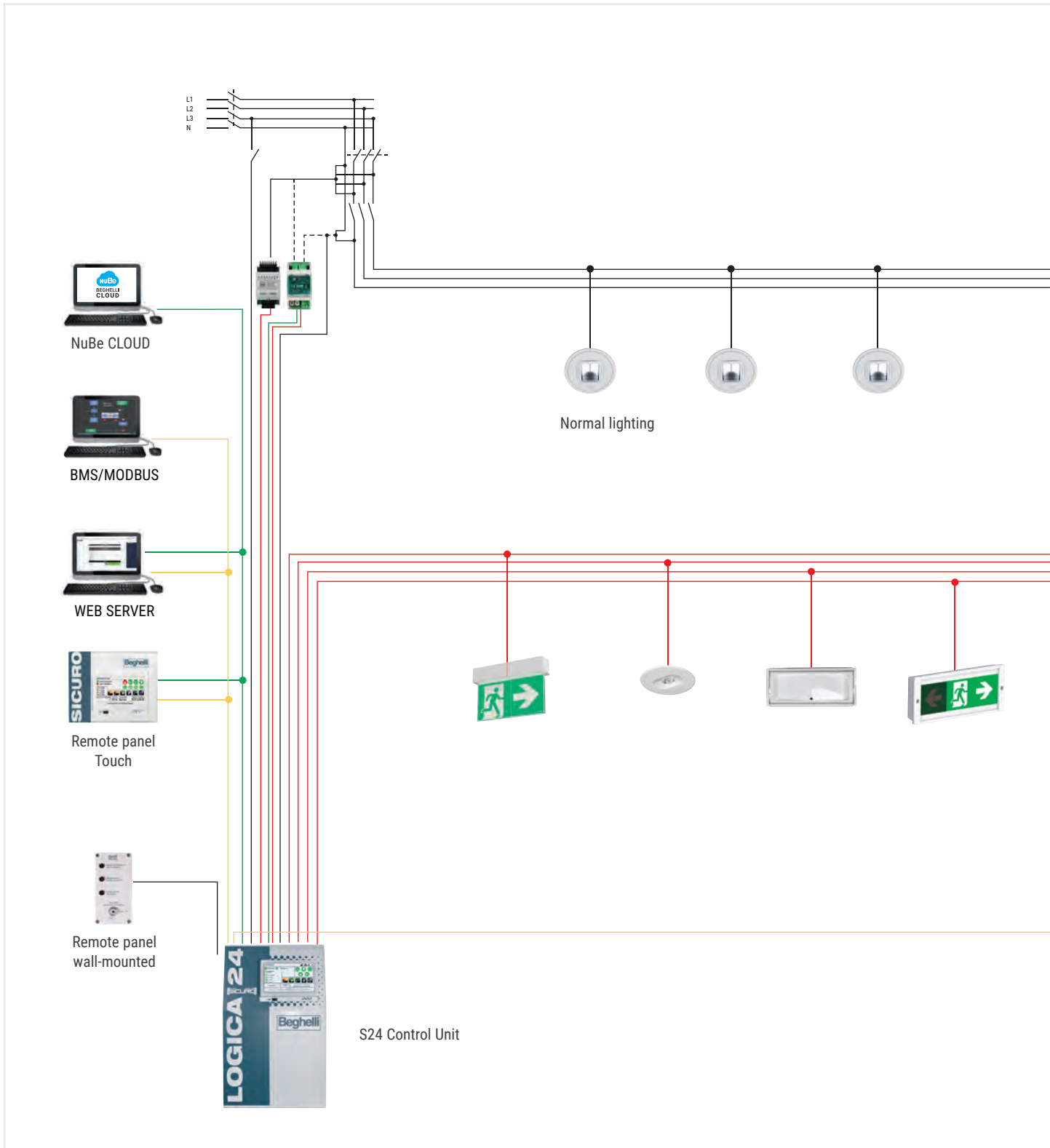

UNI 11222 standard, by communicating individually with the control unit using the power supply lines for information exchange by means of the power-line communication technology: the Control Unit sends an encoded digital transmission on the power supply lines dedicated to the luminaires, which transmission is only received by the luminaire to which it is addressed. This technology limits the number of connections and installation cables with obvious savings in material and labour.

MAXIMUM CABLE LENGTH FOR A MAXIMUM VOLTAGE DROP OF 3.5V		
Load (A)	Cross-section (mm <sup>2</sup> )	Length (m)
3	1.5	49
2	1.5	74
1	1.5	147
3	2.5	82
2	2.5	123
1	2.5	245

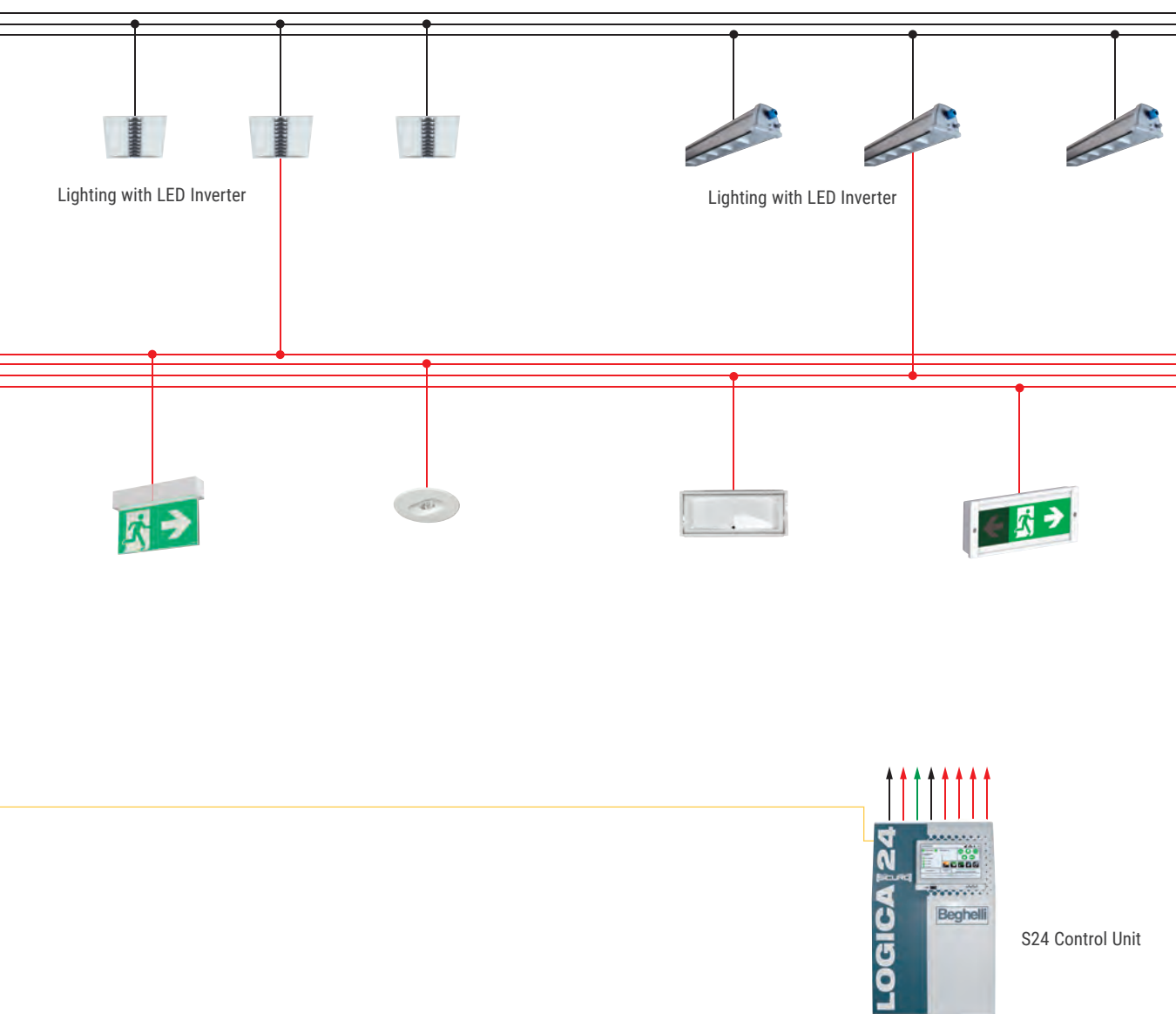

# Logica 24

emergency

## LG24 CONTROL UNIT - 4 LINES



LOGICA 24 Control Unit with 4 output circuits integrated into a metal cabinet that contains all system components and battery packs. Each output circuit can control up to 32 luminaires. Luminaire monitoring performs a functional test of the system and an endurance test to assess autonomy in case of emergency. Test results are stored in the control unit and can be shared. All LG24 control units feature a 7" colour touch screen display, the batteries are housed directly in the lower part of the control unit cabinet.

LG24

IP20

+35°C  
-5°C

316x515x140mm (17060)  
316x636x140mm (17061)  
400x800x170mm (17062/63/65/66)

	Order Code	Description	Power / Autonomy			Battery		Output circuits	Maximum current	Colour RAL	Weight Kg	CENTRALISED BATT.
			1h	2h	3h	Total capacity	Number and Type					
LG24	17060	LGS24 4U 12Ah B	156W	88.8W	67.2W	12Ah	2x 12V 12Ah	4	3A	9003	15	
	17061	LGS24 4U 24Ah B	288W	180.8W	134.4W	24Ah	4x 12V 12Ah	4	3A	9003	25.7	
	17062	LGS24 4U 28Ah G	288W	232.8W	170W	28Ah	2x 12V 28Ah	4	3A	7035	37.5	
	17063	LGS24 4U 56Ah G	288W	288W	288W	56Ah	4x 12V 28Ah	4	3A	7035	56.5	

External IN modules expandable up to 96

## LG24 CONTROL UNIT - 8 LINES



LOGICA 24 Control Unit with 8 output circuits integrated into a metal cabinet that contains all system components and battery packs. Each output circuit can control up to 32 luminaires. Luminaire monitoring performs a functional test of the system and an endurance test to assess autonomy in case of emergency. Test results are stored in the control unit and can be shared. All LG24 control units feature a 7" colour touch screen display, the batteries are housed directly in the lower part of the control unit cabinet.

LG24

IP20

+35°C  
-5°C

400x800x170mm

	Order Code	Description	Power / Autonomy			Battery		Output circuits	Maximum current	Colour RAL	Weight Kg	CENTRALISED BATT.
			1h	2h	3h	Total capacity	Number and Type					
LG24	17065	LGS24 8U 28Ah G	384W	233W	170W	28Ah	2x 12V 28Ah	8	3A	7035	39.5	
	17066	LGS24 8U 56Ah G	384W	384W	334W	56Ah	4x 12V 28Ah	8	3A	7035	58.5	

External IN modules expandable up to 96

## LG24 EXTREME CONTROL UNIT - 4 LINES



LOGICA 24 Control Unit with 4 output circuits integrated into a metal cabinet that contains all system components and battery packs. Each output circuit can control up to 32 luminaires.

Luminaire monitoring performs a functional test of the system and an endurance test to assess autonomy in case of emergency. Test results are stored in the control unit and can be shared. All LG24 control units feature a 7" colour touch screen display, the batteries are housed directly in the lower part of the control unit cabinet. LTO (Lithium Titanium) batteries guarantee high performance and reliability and can be used in extreme temperatures: -20°C +50°C.

	Order Code	Description	Power / Autonomy			Battery		Output circuits	Maximum current	Colour RAL	Weight Kg
			1h	2h	3h	Total capacity	Number and Type				
LG24	17075	LGS24 4U EXTREME LTO 20Ah	226W	130W	94W	20Ah	1x 12V 20Ah	4	3A	7035	33
	17076	LGS24 4U EXTREME LTO 40Ah	288W	288W	230W	40Ah	2x 12V 20Ah	4	3A	7035	39

External IN modules expandable up to 96

## LG24 EXTREME CONTROL UNIT - 8 LINES

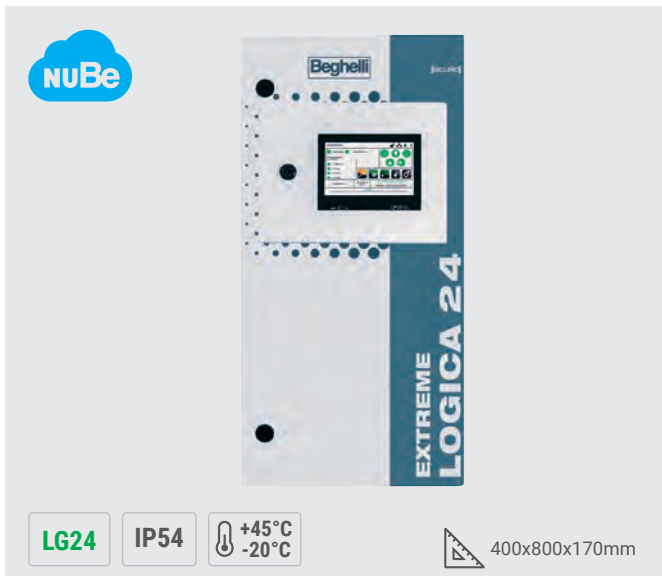

LOGICA 24 Control Unit with 8 output circuits integrated into a metal cabinet that contains all system components and battery packs. Each output circuit can control up to 32 luminaires.

Luminaire monitoring performs a functional test of the system and an endurance test to assess autonomy in case of emergency. Test results are stored in the control unit and can be shared. All LG24 control units feature a 7" colour touch screen display, the batteries are housed directly in the lower part of the control unit cabinet. LTO (Lithium Titanium) batteries guarantee high performance and reliability and can be used in extreme temperatures: -20°C +50°C.

	Order Code	Description	Power / Autonomy			Battery		Circuits power	Maximum current	Colour RAL	Weight Kg
			1h	2h	3h	Total capacity	Number and Type				
LG24	17077	LGS24 8U EXTREME LTO 20Ah	283W	130W	94W	20Ah	1x 12V 20Ah	8	3A	7035	35
	17078	LGS24 8U EXTREME LTO 40Ah	384W	319W	230W	40Ah	2x 12V 20Ah	8	3A	7035	41

External IN modules expandable up to 96

NEXT >

# Logica 24

emergency

## SYSTEM COMPONENTS



LG230

LG24

110x54x60mm

### LG24 INPUT MODULES

Ordinary mains monitoring module. It allows a selective activation of parts of the system.

8 inputs - Relay output - DIN module mounting

**LG230 module:** 230V mains check on inputs

Three-phase sensor on inputs 1,2,3

**LG24 module:** Check of isolated changeover contacts

Order Code	Description	Weight Kg
17230	S230 S24 230V DIN INPUT MODULE	0.2
17231	S230 S24 24V DIN INPUT MODULE	0.2



LG24

239x46x30mm (17220)  
301x139x55mm (17210)

### LG24 6-12W LED INVERTER

Module with plastic housing for installation inside LED luminaires with the Driver output voltage from 2 to 55V. It allows the management of LED emergency luminaires.

Order Code	Description	Protection rating	Weight Kg
17210	INV LED IP65 LOGICA 24V	IP65	0.8
17220	INV LED SLGS LOGICA 24V	IP40	0.1

## ACCESSORY



### NETWORK SENSOR

Mains power monitoring module for normal lighting, activation of the output control in the event of a failure on the mains:  $U < 0.6 UN$  per 0.5 s.  
DS3 - UV 1-3 PHASE MONITORING

Order Code **17385**  
Order Code **17206N**  
Order Code **17226**



### WALL-MOUNTED REMOTE PANEL

Operation mode control for both LG230 and LG24 systems

Order Code **17207**



### REMOTE TOUCH SCREEN PANEL

Control of up to 63 control units with multiple functions. It integrates a 7" graphic touch screen display

Order Code **17240**



### RECESSED REMOTE PANEL

Operation mode control for both LG230 and LG24 systems

Order Code **17208**



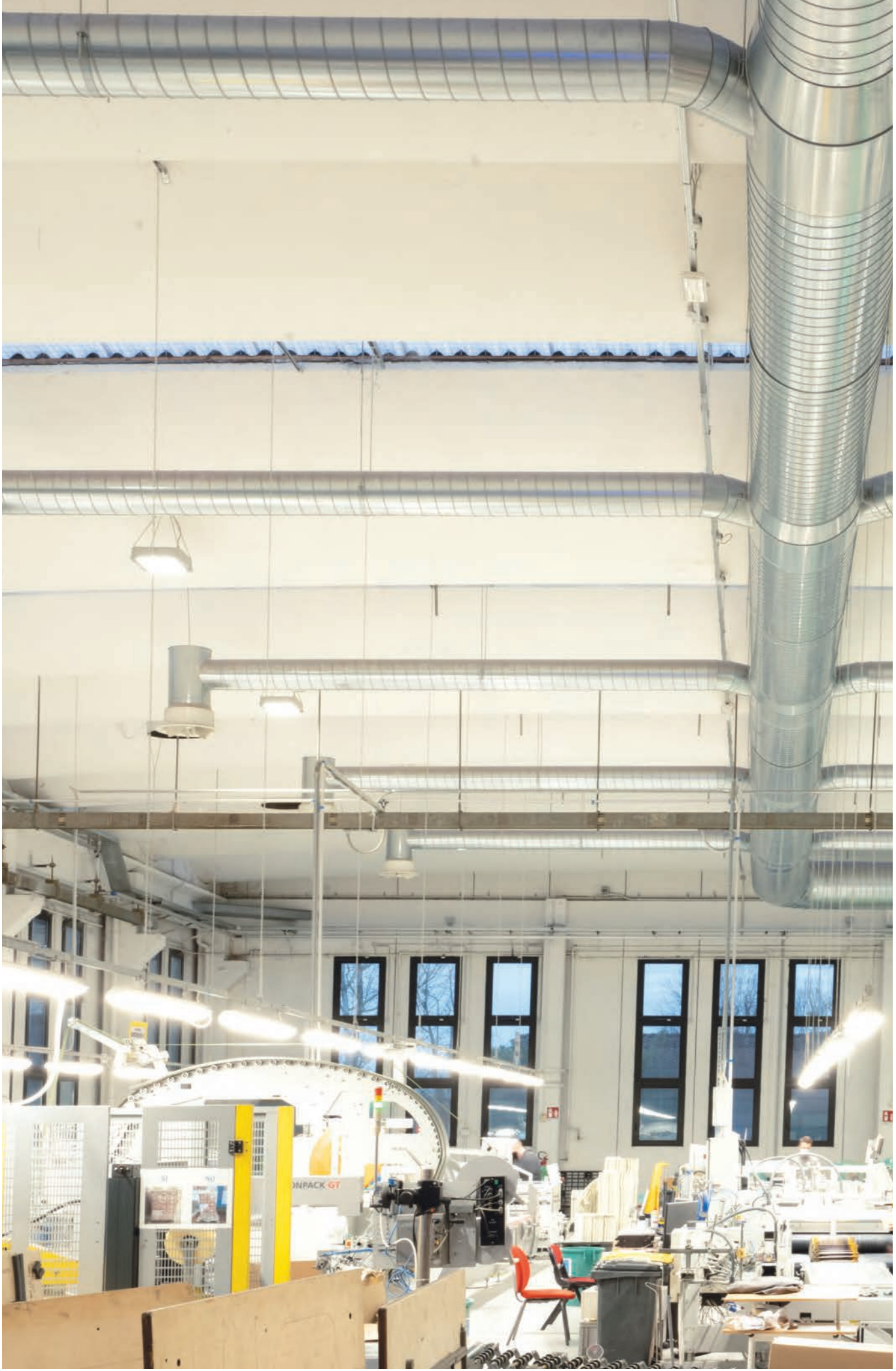

127 centralised battery systems

# Logica 24 Dynamic

emergency



Rescue and safety signs are designed to illuminate the safe place outside the building or towards the assembly points, indicating the shortest route even in the event of power failures. In the event of fire, however, escape routes may be obstructed by smoke or fire. Only a dynamic emergency system can take into account these situations, visually blocking unusable escape routes and showing safe alternatives. People's lives, as a top priority, thanks to a system that contributes to the safe evacuation of buildings.



The dynamic system can be integrated into any system with LG24 or LG24 Extreme control units, interfacing the system, for example, with the fire fighting system.

## EVOLVING SAFETY REGULATIONS

Dynamic safety signalling systems are part of an evolving regulatory framework which, starting from the cornerstones of safety signalling at the workplace, regulated in general terms by Legislative Decree 81/08 and in particular terms by specific "Vertical" rules, is developing through the most modern principles set out in Ministerial Decree of 03 August 2015 (Approval of technical standards for fire prevention).

This provision explicitly refers to the responsibilities of the persons in charge of the best coordination of escape routes and their functions (ref. S.4.5.3, 4.5.8, 4.8.4).

### LG24 CONTROL UNITS



### LG24 DYNAMIC LUMINAIRES



## DYNAMIC SIGNAGE OF ESCAPE ROUTES FOR SAFE EVACUATION

The LOGICA 24 system makes it possible to increase the safety of workplaces, in particular complex places with more than one escape route, by managing conflict situations, the unavailability of escape routes for emergency situations (smoke or something else that prevents evacuation through that escape route).

The system is also particularly suitable in crowded places where bystanders are unfamiliar with the location. In these situations, it has been experimentally demonstrated that, in a situation of emergency, people are directed to leave the place by going back on the route they used to get there. By capturing the attention of bystanders to a greater extent and providing additional information in addition to the direction of escape, Variable and Dynamic signalling reduces these potentially

dangerous situations.

The LOGICA 24 Dynamic System is an evolution of the LOGICA 24 System, with which it shares the control units and various interface devices. The system is connected to the building's fire fighting system via the potential-free contacts of the S24 input modules. If one or more smoke sensors send(s) a signal, the fire fighting control unit will trigger a change of status of the inputs and of the preset signalling scenarios. The emergency signalling scenarios, which are automatically activated in the event of a fire, indicate escape routes that are not at risk and activate the change of direction on the luminaires, or they block access to areas at risk with the illumination of safety signs prohibiting access.

### A DYNAMIC SYSTEM IS BASED ON TWO FUNDAMENTAL PRINCIPLES:

1. prevent people from taking dangerous smoke-saturated escape routes
2. enable people in areas already saturated with smoke to take safer escape routes.

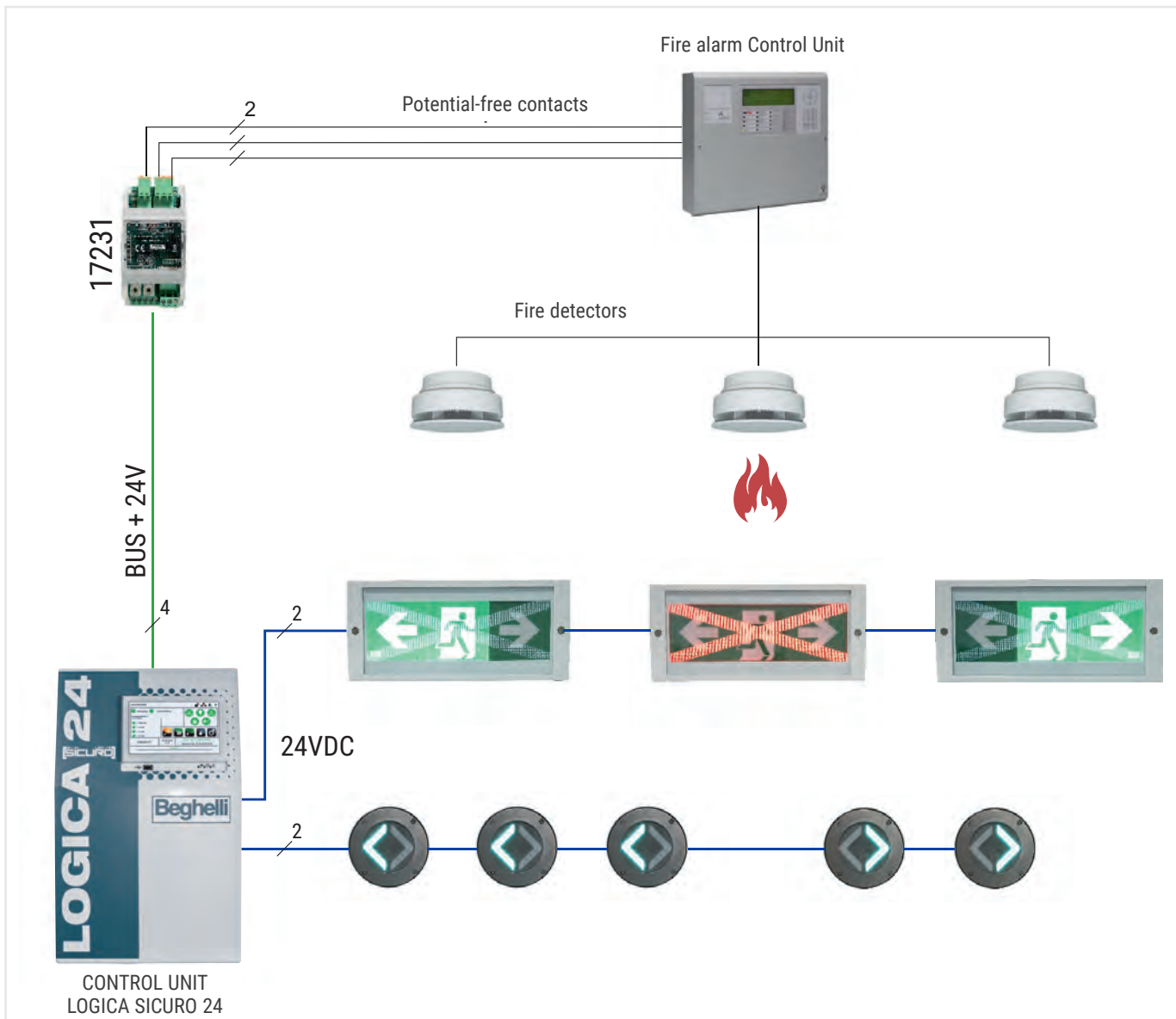



# Logica 24 Dynamic

emergency

SYSTEM WITH LG24 DYNAMIC SYSTEM IN STATIC MODE

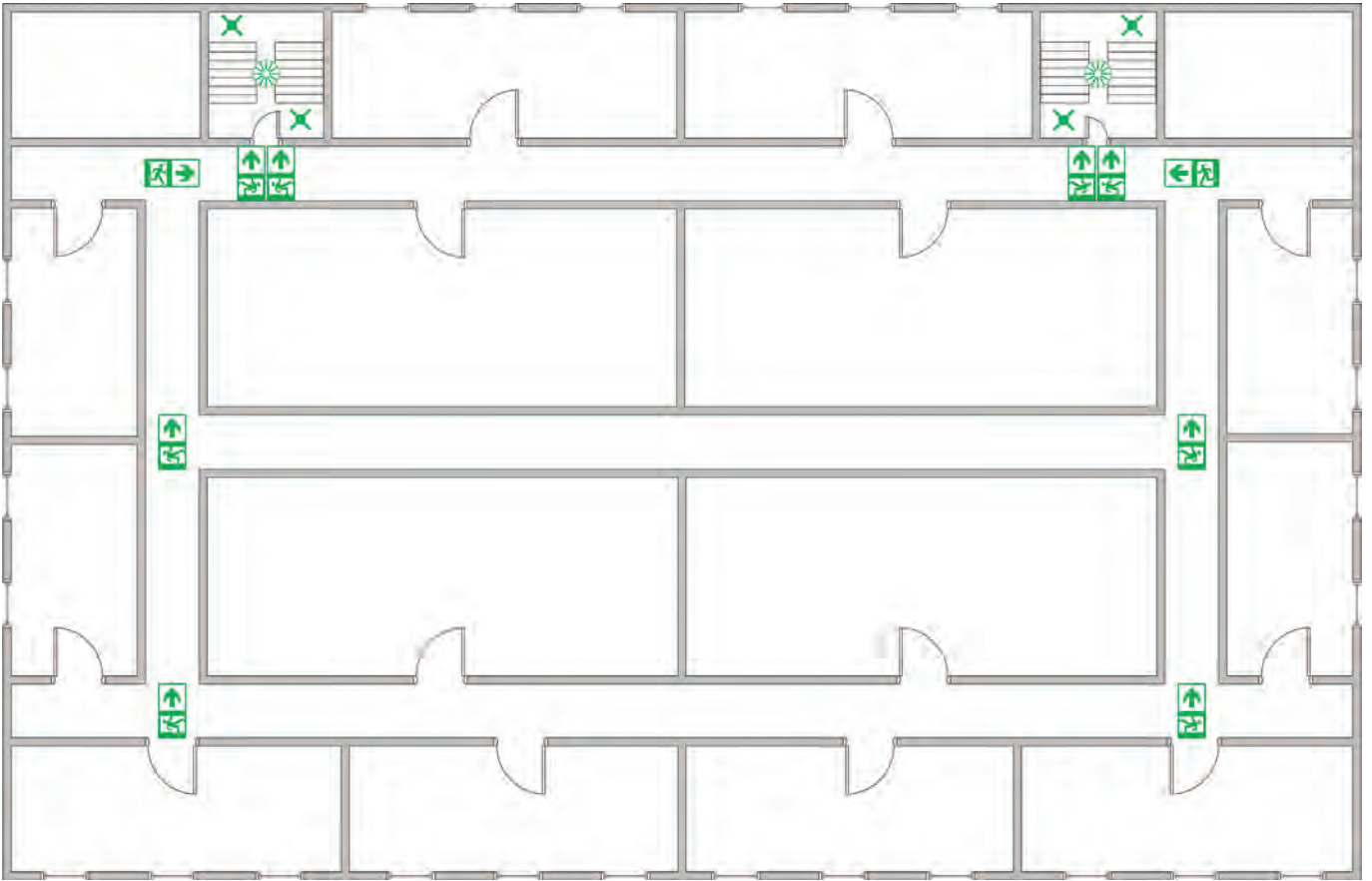

SYSTEM WITH LG24 DYNAMIC SYSTEM IN DYNAMIC MODE

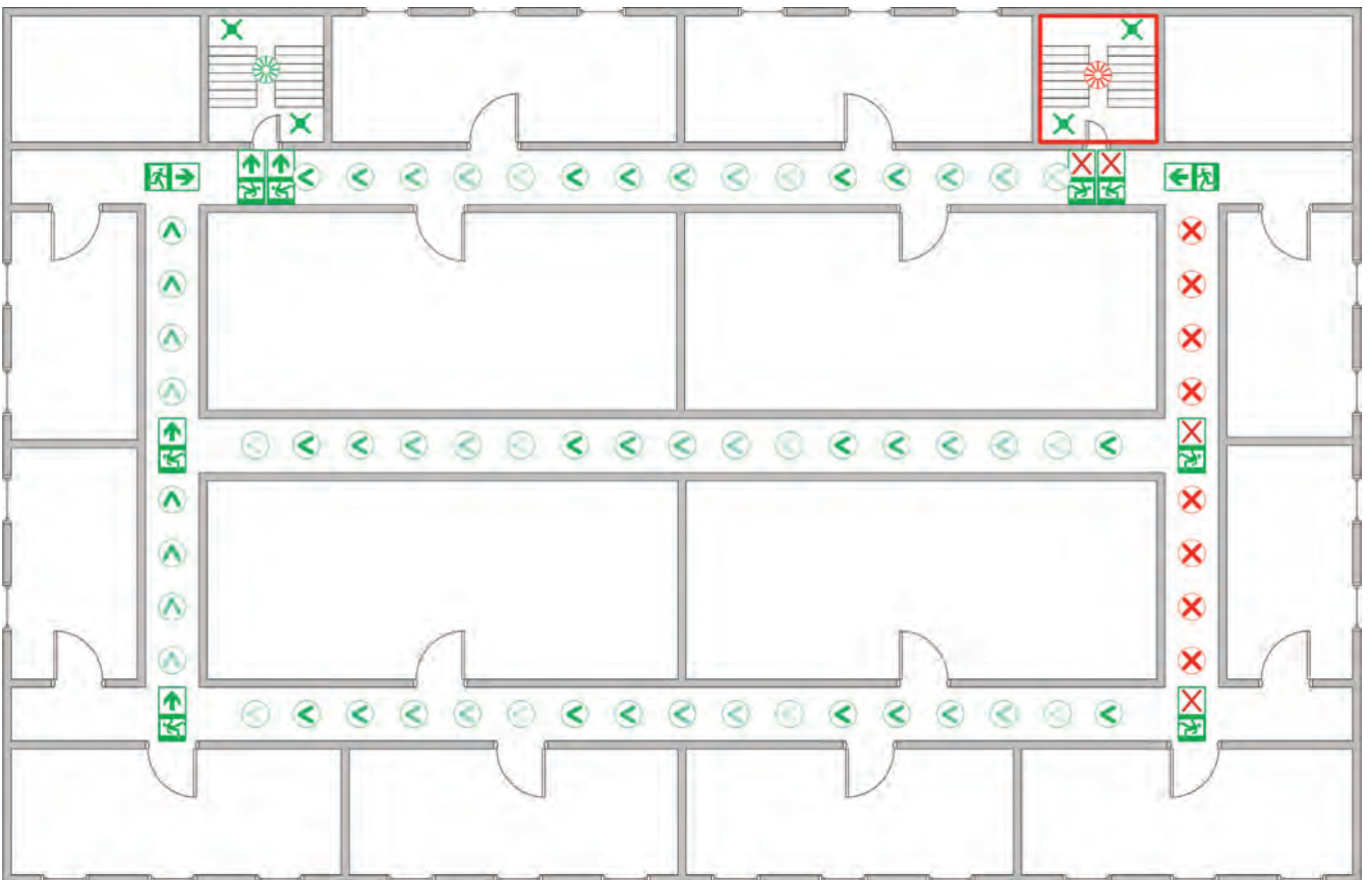

## FIRE EXIT SIGN



Dynamic emergency luminaire for exiting high-risk areas. The connection with the LG24 Control Unit, which interfaces with the sensors of the fire fighting system, makes it possible to determine the escape route with the lowest risk index in the event of smoke or fire. This luminaire makes it possible to drastically reduce the risk to people during emergency escape in the event of a fire.

LG24

IP65



392x175x60mm



**DANGER SITUATION ON THE RIGHT**  
The LG24 Dynamic system **indicates** the escape route to the left



**DANGEROUS SITUATION ON THE LEFT**  
The LG24 Dynamic system **indicates** the escape route to the right



**SERIOUS DANGER SITUATION**  
The LG24 Dynamic system **blocks** access to hazardous areas.

	Order Code	W eq.	Description	DC power input W	Weight Kg	Packaging
LG24	34000	24	LGS24 DYNAMIC FIRE EXIT SIGN	2.8	2.8	6

## FIRE EXIT STEP SIGN



Dynamic emergency luminaire for exiting high-risk areas. The connection with the LG24 Control Unit, which is interfaced with the sensors of the fire fighting system, makes it possible to determine the escape route with the lowest risk index. This luminaire, which drastically reduces the risk to people in the event of a fire, can be installed on the ground, even where great strength is required, such as tunnels or basements. Its positioning makes it possible to detect the output signal even when the smoke does not allow the signals above to be seen.

LG24

IP65



Ø140, Ø90, H120mm



	Order Code	W eq.	Description	DC power input W	Weight Kg	Packaging
LG24	34002	24	LGS24 DYNAMIC FIRE EXIT STEP SIGN	1.6	1.1	6

# Emergency power supply units

emergency



IP21

+40°C  
-0°C



SOCC.CA SE/SA emergency power supply units are characterised by a high input power factor, high efficiency and reliability, and are supplied with two outputs: SA, to supply a permanent load, and SE supplied only in the event of a failure on the mains. In the event of a blackout, voltage will be supplied to both outputs by the inverter drawing current from the battery pack. If the mains voltage repeatedly goes out of specification (3 times in 2 minutes) the emergency power supply unit will work as a UPS until the mains returns to normal for at least 30 minutes; this ensures power quality to the load.

The emergency power supply units are equipped with LCD displays and monitoring software.



Wide range to meet all requirements with powers available from 1000VA to 10kVA. The battery packs are contained in external pieces of furniture and can be composed to achieve the desired autonomy.

## BOX FOR HOUSING EXTERNAL BATTERY PACKS

Line equipped with an external battery pack housed in a matt black powder-coated sheet metal box with a design coordinated with the control unit of the emergency power supply unit. Access to the batteries is provided by tilting doors with air intakes designed for cooling. The Box is available in 3 sizes to meet all system requirements.



Order Code	Dimensions of the emergency power supply unit mm			Box dimensions mm		
	L	B	H	L	B	H
17700,17701	145	400	220	450	450	610
17702	145	400	220	780	450	610
17703	192	460	347	450	450	610
17704,17705, 17706, 17707, 17708	192	460	347	780	450	610
17709, 17710, 17711, 17712, 17713, 17714, 17715, 17716, 17717, 17718, 17719, 17720	260	550	708	950	470	1190



































	1KVA	2KVA	3KVA	4KVA	6KVA	8KVA	10KVA
<b>VA/W</b>	1000/800	2000/1600	3000/2400	4000/3600	6000/5400	8000/7200	10000/9000
<b>PHASE</b>	Single-phase + earth						
<b>VOLTAGE</b>	178~275VAC						
<b>FREQUENCY</b>	46~54Hz / 56~64Hz						
<b>POWER FACTOR</b>	≥0.98						
<b>CONNECTION</b>	Three-pole mains cable with Schuko plug			Terminal block			
<b>VOLTAGE</b>	208/220/230/240VAC ±2%						
<b>WAVE FORM</b>	Sinusoidal						
<b>HARMONIC DISTORTION</b>	THD<5%						
<b>FREQUENCY</b>	46~54Hz / 56~64Hz Synchronised						
	50/60 ±0.1Hz from the battery						
<b>CREST FACTOR</b>	3:1 max						
<b>CONNECTION</b>	1 Schuko (SA output) Schuko (SE output)	2 Schuko + Terminal block (SA output) Schuko (SE output)	2 Schuko + Terminal block (SA output) Schuko (SE output)	Terminal block			
<b>NO NETWORK</b>	<20ms						
<b>INVERTER</b>	<20ms						
<b>FROM THE NETWORK</b>	87% - 89%						
<b>FROM THE BATTERY</b>	81% - 84% - 86%						
<b>TYPE</b>	12V sealed Pb						
<b>NUMBER</b>	Depending on model*						
<b>AUTONOMY</b>	Depends on battery						
<b>LOAD</b>	Depends on battery						
<b>FROM THE NETWORK</b>	60s @ 100%~130%						
<b>FROM THE BATTERY</b>	10s @ 100%~130%						
<b>NOISE</b>	<50dB @ 1m						

	Order Code	Description	Power VA	Active power W	Power according to the EN50171 standard W	Battery	No. of batteries	Autonomy h
HT230	17700	SOCC.CA SE/SA 1KVA 1P 1ELM	1000	800	670	PB 12V 55Ah	3	1
	17701	SOCC.CA SE/SA 1KVA 2P 1ELM	1000	800	670	PB 12V 85Ah	3	2
	17702	SOCC.CA SE/SA 1KVA 3P 1ELM	1000	800	670	PB 12V 120Ah	3	3
	17703	SOCC.CA SE/SA 2KVA 1P 1ELM	2000	1600	1300	PB 12V 33Ah	8	1
	17704	SOCC.CA SE/SA 2KVA 2P 1ELM	2000	1600	1300	PB 12V 55Ah	8	2
	17705	SOCC.CA SE/SA 2KVA 3P 1ELM	2000	1600	1300	PB 12V75Ah	8	3
	17706	SOCC.CA SE/SA 3KVA 1P 1ELM	3000	2400	2000	PB 12V 55Ah	8	1
	17707	SOCC.CA SE/SA 3KVA 2P 1ELM	3000	2400	2000	PB 12V 80Ah	8	2
	17708	SOCC.CA SE/SA 3KVA 3P 1ELM	3000	2400	2000	PB 12V 120Ah	8	3
	17709	SOCC.CA SE/SA 4KVA 1P 1ELM	4000	3600	3000	PB 12V 28Ah	20	1
	17710	SOCC.CA SE/SA 4KVA 2P 1ELM	4000	3600	3000	PB 12V 55Ah	20	2
	17711	SOCC.CA SE/SA 4KVA 3P 1ELM	4000	3600	3000	PB 12V 70Ah	20	3
	17712	SOCC.CA SE/SA 6KVA 1P 1ELM	6000	4800	4000	PB 12V 40Ah	20	1
	17713	SOCC.CA SE/SA 6KVA 2P 1ELM	6000	4800	4000	PB 12V 70Ah	20	2
	17714	SOCC.CA SE/SA 6KVA 3P 1ELM	6000	4800	4000	PB 12V 100Ah	20	3
	17715	SOCC.CA SE/SA 8KVA 1P 1ELM	8000	6600	5500	PB 12V 55Ah	20	1
	17716	SOCC.CA SE/SA 8KVA 2P 1ELM	8000	6600	5500	PB 12V 85Ah	20	2
	17717	SOCC.CA SE/SA 8KVA 3P 1ELM	8000	6600	5500	PB 12V 134Ah	20	3
	17718	SOCC.CA SE/SA 10KVA 1P 1ELM	10000	8400	7000	PB 12V 70Ah	20	1
	17719	SOCC.CA SE/SA 10KVA 2P 1ELM	10000	8400	7000	PB 12V 120Ah	20	2
17720	SOCC.CA SE/SA 10KVA 3P 2ELM	10000	8400	7000	PB 12V 80Ah	2x20*	3	

\* 2 BOXES per battery pack

# Key to symbols

## GENERAL CHARACTERISTICS: MEANING OF SYMBOLS

SYMBOL	DESCRIPTION	SYMBOL	DESCRIPTION
	Single cloud platform for the remote management of all lighting and emergency lighting systems.		Hybrid emergency lighting luminaires from the SanificaAria series, incorporating a UV-C flow cell air sanitisation system.
	Control Unit or Luminaire manageable directly by from the B.connect APP: it enables optical communications to the luminaire and local WiFi connections to the control unit. It also allows direct access to the nuBe cloud platform.		Luminaires from the ArchiEco series, an emergency range with a particularly evolved design, intended for the world of lighting designers and made from entirely renewable and compostable raw materials.
	Device for enabling the Rest Mode function on emergency luminaires		General description defining the type of luminaire.
	Emergency fixtures for <b>non-permanent</b> lighting		Luminaires with special features for versatility of use.
	Emergency fixtures for <b>permanent</b> lighting		Luminaires with special lighting characteristics. High luminous flux and beam control.
	Self-contained luminaires without diagnostics.		Luminaires with special mounting solutions, in terms of installation speed and/or multiple connections or through-wiring.
	Self-contained luminaires with local diagnostics, AutoTest series.		Luminaires with a motion sensor for automatic lighting activation.
	Self-contained luminaires with local AutoTest diagnostics and Opticom optical programming technology. Using the Beghelli Opticom APP, which can be downloaded from the various stores, it is possible to control and program the luminaires. By integrating the corresponding LG or LGFM modules, the luminaire switches from local Autotest (AT) diagnostics to centralised CentralTest diagnostics.		Luminaires suitable for architectural applications, with a surface treatment that allows them to be painted with normal wall paints.
	Self-contained luminaires with local AutoTest diagnostics prepared for expansion into CentralTest central diagnostics, with only the integration of the Cablecom (CBL) control unit into the system, without additional modifications. As soon as it is power supplied, the CBL Control Unit automatically connects with and takes control over the AT-CBL luminaires.		Laser module for projecting safety signs on the ground. The optional device can be integrated into certain prepared luminaires (DOT, IRON FLAG)
	Self-contained luminaires with centralised diagnostics via BUS Logica (LG). If the LG Control Unit is not present, the luminaires are configured in AT mode.		Protection rating against external factors according to EN 60598-1. If it is double, highlight two versions of the luminaire or a specific optional accessory.
	Self-contained luminaires with centralised radio diagnostics and remote control from an LGFM Control Unit. If the Control Unit is not present, the luminaires are configured in AT mode.		Protection rating against impact according to EN 50102.
	Emergency luminaires interfaced with DALI communication BUS.		Resistance temperature of the luminaire at the Glow Wire Test according to IEC EN 60598-1.
	Emergency luminaires with centralised 230V power supply. Diagnostics and control of the centralised luminaires.		Luminaires in which protection against electric shock is guaranteed by an Insulation Class II built.
	Emergency luminaires with centralised 24V power supply. Diagnostics and control of the centralised luminaires.		General temperature range in which the luminaire maintains correctly its characteristics. For details of the characteristics of each individual product, please refer to the electronic catalogue at <a href="http://www.beghelli.it">www.beghelli.it</a> .
	Emergency luminaires with centralised power supply, without diagnostics.		European quality label. Voluntary certification to testify to the quality of the product and the production chain.
	Luminaires with an LTO Lithium Battery. Thanks to the special features of the battery, these luminaires come with a 10-year warranty for all components, including the battery.		Luminaire intended for use in areas where there is a risk of explosion due to the presence of explosive substances (dust and/or gas...) according to the <b>ATEX Directive</b> .

# Analytical index

## LUMINAIRES

Order Code	Price €	Page	Order Code	Price €	Page	Order Code	Price €	Page
250SA	74.00	029	4300	91.66	037	8596	115.75	035
250SE	65.50	029	4301	120.70	037	8597	115.10	033
250ATSA	86.00	029	4302	143.90	037	8598	143.60	033
250ATSE	76.30	029	4303	191.48	037	12182	334.60	015
250ATSAUV	241.05	071	4304	216.76	037	12182FM	464.91	013
250ATSEUV	232.03	071	4320	138.11	089	12183	345.35	013
250SAUV	231.25	071	4321	149.71	089	12183FM	477.30	013
250SEUV	223.23	071	4322	530.00	089	12184	511.13	013
500ATSA	158.08	029	4330	103.29	051	12184FM	632.37	013
500ATSAUV	443.08	071	4331	116.00	051	12185	472.66	013
500ATSE	139.99	029	4334	112.52	051	12185FM	596.63	013
500ATSEUV	425.71	071	4335	125.18	051	12186	485.05	013
500SA	109.19	029	4370	160.49	037	12186FM	609.05	013
500SE	100.58	029	4371	219.76	037	12187	637.00	013
500SAUV	341.22	071	4372	250.52	037	12187FM	760.88	013
500SEUV	342.79	071	4372BA	259.00	091	15030	522.23	063
824L	77.02	037	4373	311.47	037	15032	686.93	063
824M	64.19	037	4380	182.79	089	17403	92.90	013
824S	56.74	037	4381	194.36	089	17404	95.48	013
824BA	104.91	091	4390	138.20	051	17405	98.06	013
824LSA	121.33	037	4391	219.79	051	17406	107.87	013
824MSA	95.65	037	4393	152.02	051	17423	95.00	045
1499	46.35	043	4400	57.84	031	17424	115.00	045
1499/24	47.38	043	4401	71.08	031	17435	100.16	026
1499L	50.99	043	4402	107.09	031	17436	103.50	026
1499LUV	186.00	071	4403	72.39	031	17437	106.83	026
4101	77.30	039	4404	85.59	031	17438	117.99	026
4102	90.89	039	4405	151.13	031	17452	143.06	063
4103	103.49	039	4601	96.07	057	17876	157.50	047
4104	164.38	039	4602	108.01	057	17877	170.50	047
4105	164.74	039	4603	125.16	057	17878	157.50	049
4106	220.46	039	4605	162.99	057	17879	170.50	049
4107	109.82	039	4607	54.12	055	17880	136.50	081
4108	113.30	039	4609	67.83	055	17881	124.80	081
4109	178.93	039	4611	31.23	059	17882	110.76	081
4110	183.35	039	4612	40.91	059	17890	184.80	087
4111	252.03	039	8584	81.37	033	17891	208.00	087
4200	121.50	039	8585	190.04	033	17892	221.76	087
4201	141.55	039	8586	91.67	033	17893	249.60	087
4202	195.82	039	8587	203.26	033	17894	184.80	087
4203	224.26	039	8590	112.65	033	17895	201.60	087
4204	268.03	039	8591	135.39	033	17896	221.76	087
4290A	72.59	079	8592	196.83	033	17897	246.53	087
4291A	81.35	079	8593	245.76	033	17898	161.70	087
4292A	93.85	079	8594	71.07	035	17899	176.40	087
4293A	108.88	079	8595	81.37	035			

\* For the commercial conditions, please contact the Beghelli sales network

NEXT >

# Analytical index

emergency

## LUMINAIRES

Order Code	Price €	Page	Order Code	Price €	Page	Order Code	Price €	Page
17900	203.28	087	19338	179.37	049	19620	176.55	077
17901	221.76	087	19339	197.62	049	19621	241.73	077
17902	402.04	083	19355L	134.20	095	19622	275.58	077
17903	451.09	083	19358	78.51	093	19623	339.35	077
17904	300.43	083	19359	101.27	093	19700	140.65	081
17908	354.64	085	19367	91.35	093	19711	190.01	081
17909	354.64	085	19368	207.52	093	19712	237.53	081
17910	360.36	085	19370	251.12	065	19800	157.30	087
17911	120.00	089	19371	118.66	093	19801	170.52	087
17912	144.00	089	19373	212.67	093	19802	188.76	087
17913	460.50	089	19378	473.47	065	19803	204.61	087
17914	120.00	089	19390	163.23	097	19810	208.18	087
17915	144.00	089	19391	147.69	097	19811	221.37	087
17916	460.50	089	19410	307.96	013	19812	239.41	087
17917	105.00	089	19411	346.46	013	19813	254.56	087
17918	126.00	089	19420	158.85	045	31053	341.64	063
17919	402.94	089	19421	279.83	045	31054	273.31	063
18200	398.74	083	19430	105.98	025	31090	240.00	053
18201	469.14	083	19430UV	269.39	073	31092	147.40	053
18400	337.41	085	19431	115.23	025	31099	243.05	013
18401	446.55	085	19431UV	278.37	073	31112	208.36	065
19200	122.89	025	19432	165.84	025	31113	166.69	065
19201	150.58	025	19432UV	327.51	073	31120	233.72	013
19202	163.66	025	19433	177.08	025	31121	145.00	045
19203	228.68	025	19433UV	338.42	075	31122	151.40	026
19204	302.01	025	19434	277.16	026	31123	204.00	045
19205	334.66	025	19435	310.43	026	31124	129.03	026
19206	171.73	025	19450	80.34	017	31125	133.33	026
19207	245.06	025	19450UV	244.50	075	31140	201.29	013
19208	310.24	025	19451	172.46	017	31141	214.83	013
19209	375.44	025	19451UV	333.94	075	31150	137.63	026
19210	269.48	025	19452	94.09	017	31170	161.81	017
19211	368.76	025	19452UV	257.85	075	31171	201.85	017
19212	378.71	025	19453	200.08	017	31172	207.84	021
19213	465.09	025	19453UV	360.75	075	31174	110.32	017
19290	165.64	025	19454	180.00	017	31175	107.13	017
19291	180.51	025	19455	210.00	017	31176	166.27	021
19292	261.46	025	19460	248.75	017	31208	264.00	053
19293	326.01	025	19460UV	408.00	075	31210	162.14	053
19294	282.25	025	19461	275.78	021	32055	341.64	063
19295	333.67	025	19470	301.74	017	32067	220.00	053
19296	407.56	025	19471	323.37	021	32083	208.36	065
19320	100.16	047	19600	73.11	077	32089	210.35	013
19328	179.37	047	19601	87.73	077	32090	130.00	045
19329	197.62	047	19602	108.93	077	32091	151.40	026
19330	100.16	049	19603	138.20	077	32092	273.31	063

\* For the commercial conditions, please contact the Beghelli sales network

## LUMINAIRES

Order Code	Price €	Page
32093	150.00	045
32094	116.13	026
32096	167.23	013
32110	139.01	017
32111	192.14	017
32112	247.43	021
32122	242.00	053
37126	259.56	053
37127	304.31	053
37128	372.01	053
37236	285.52	053
37237	334.75	053
37238	409.21	053
81143	50.90	061
81144	52.90	061
R0818	152.31	025
R1124	162.94	025
R1124SA	257.08	025
R2436	248.62	025
R2436SA	322.91	025

## ACCESSORY

Order Code	Price €	Page
2741	9.07	033
2742	9.76	029
2751	20.74	029, 031
3723	6.27	018, 022, 029, 031, 071, 075
3727	6.98	031, 035, 045
3733	13.16	040, 043, 069, 079
3893	4.97	031
3903	37.22	037, 077
3905	98.18	033, 035, 063
3912	46.45	014, 018, 022, 026, 029, 031, 040, 043, 069
4112	16.18	040
4117	4.97	029, 071
4124	46.66	029, 071
4125	46.66	029, 071
4126	46.66	029, 071
4265	38.76	040, 043, 079
4266	30.97	040, 043, 069, 079
4267	62.00	040, 043, 079
4268	62.00	040, 043, 079
4269	16.09	040, 043, 069, 079
4278	8.22	040, 043, 069, 079
4312	41.56	089
4313	45.12	089
4315	68.89	018, 022, 075, 089
4316	77.19	018, 022, 075, 089
4317	86.70	018, 022, 075, 089
4318	7.00	037
4319	47.51	037, 077, 089, 091
4325	19.44	033
4326	9.06	037
4329	6.40	077
4681	72.66	018, 075
4682	6.40	018, 075
4683	12.98	022, 018
4685	19.47	020, 018, 075
4686	20.03	018, 075
4687	27.58	018, 022
11593	12.31	033, 035
11594	12.31	033, 035
11595	12.31	033, 035
12175	19.52	014
12176	19.52	014
12177	19.52	014
12178	20.85	014
12179	13.59	014
12180	22.10	014

Order Code	Price €	Page
12199	20.37	014
12941	9.55	045
12942	16.92	045
12943	20.29	045
14771	23.00	089
15043	37.85	066
15044	75.17	066
15048	10.00	029, 031
19040	15.05	026
19041	50.77	026
19042	53.66	026, 073
19043	53.66	026, 073
19044	6.62	026, 073
19045	10.16	026, 089, 073
19046	59.37	063
19048	17.81	026
19049	54.63	026
19064	103.88	063
19376	55.97	095, 097
19880	60.00	087
19881	70.00	087
19882	46.35	087
19883	59.23	081
19884	71.28	087
20155	15.00	018, 022
20156	16.00	018, 022
26723	90.00	071, 073, 075
26724	88.00	069
81236	6.70	061
81237	6.70	061
81296E	23.10	061
F95807	15.00	047, 049
F95808	15.00	047, 049
F95815	15.00	047, 049
F95819	10.00	047, 049
RA01	12.26	026
RA04	47.01	018, 014, 022, 045
RA05	24.52	045
RA06	17.73	026, 095
RA07	69.00	097
RA08	36.00	063, 097

\* For the commercial conditions, please contact the Beghelli sales network

NEXT >

# Analytical index

emergency

## CONTROL SYSTEMS

Order Code	Price €	Page	Order Code	Price €	Page	Order Code	Price €	Page
2730	188.36	026,031,037,051,081,083, 085,091,089	17606	6,300.00	113	17658	24,000.00	115
12100C	1,000.00	101	17610	6,500.00	113	17659	23,500.00	115
12101	327.59	107	17611	6,650.00	113	17660	23,950.00	115
12128C	1,400.00	103	17612	6,450.00	113	17661	24,400.00	115
12131C	2,300.00	101	17613	7,650.00	113	17662	24,550.00	115
15036	45.88	105	17614	7,785.00	113	17663	25,050.00	115
15037	69.39	105	17615	7,965.00	113	17664	25,550.00	115
15038	81.94	105	17616	9,115.00	113	17665	26,500.00	115
15047	74.11	105	17617	9,300.00	113	17666	27,000.00	115
17060	2,700.00	124	17618	8,980.00	113	17667	27,500.00	115
17061	3,000.00	124	17620	8,650.00	114	17668	27,000.00	115
17062	4,000.00	124	17621	8,350.00	114	17669	27,500.00	115
17063	4,400.00	124	17622	8,550.00	114	17670	28,000.00	115
17064	2,700.00	116	17623	9,500.00	114	17671	35,000.00	115
17065	4,300.00	124	17624	9,700.00	114	17672	35,750.00	115
17066	4,900.00	124	17625	9,500.00	114	17673	36,500.00	115
17075	4,500.00	125	17626	10,300.00	114	17674	40,000.00	115
17076	5,500.00	125	17627	10,500.00	114	17675	40,500.00	115
17077	4,900.00	125	17628	10,800.00	114	17676	41,250.00	115, 126
17078	6,400.00	125	17629	11,500.00	114	17680	4,500.00	116
17206N	103.00	126	17630	11,700.00	114	17681	5,250.00	116
17207	242.05	119,126	17631	12,000.00	114	17682	6,500.00	116
17208	262.65	119,126	17632	12,600.00	114	17685	1,550.00	117
17210	116.26	126	17633	12,850.00	114	17686	2,550.00	117
17220	90.86	126	17634	13,500.00	114	17700	2,576.12	133
17226	87.55	119,126	17635	15,000.00	114	17701	*	133
17230	164.80	117, 126	17636	15,300.00	114	17702	*	133
17231	180.25	117, 126	17637	15,600.00	114	17703	3,864.17	133
17232	412.00	119	17638	16,500.00	114	17704	*	133
17233	412.00	119	17639	16,850.00	114	17705	*	133
17234	442.90	119	17640	17,200.00	114	17706	5,152.23	133
17235	412.00	119	17641	19,000.00	114	17707	*	133
17236	40.50	117	17642	19,400.00	114	17708	*	133
17237	29.87	119	17643	19,750.00	114	17709	7,728.34	133
17240	1,431.70	119,126	17644	20,500.00	114	17710	*	133
17381	81.77	118	17645	20,900.00	114	17711	*	133
17382	74.16	118	17646	21,350.00	114	17712	9,016.40	133
17383	81.37	118	17650	20,500.00	115	17713	*	133
17384	566.50	119	17651	21,000.00	115	17714	*	133
17385	105.00	119	17652	21,350.00	115	17715	11,592.52	133
17601	5,185.00	113	17653	21,900.00	115	17716	*	133
17602	5,345.00	113	17654	22,350.00	115	17717	*	133
17603	5,600.00	113	17655	22,750.00	115	17718	15,456.69	133
17604	5,650.00	113	17656	23,250.00	115	17719	*	133
17605	6,165.00	113	17657	23,650.00	115	17720	*	133

\* For the commercial conditions, please contact the Beghelli sales network



## CONTROL SYSTEMS

Order Code	Price €	Page
19375	67.16	105
20151	173.04	099
20157	1,100.00	099, 101,103
21102	1,400.00	105
34000	638.40	131
34002	560.00	131
RA09	39.24	117

# Spare batteries

emergency

## BATTERIES FOR SELF-CONTAINED EMERGENCY LUMINAIRES

Order code Luminaires	Order code battery	Description battery	Order code Luminaires	Order code battery	Description battery	Order code Luminaires	Order code battery	Description battery
250ATSA	415419001	LTO 4.8V 1.2Ah	4304	415399001	NiMh 3.6V 1.5Ah	12184	415139000	Pb 6V 4Ah
250ATSE	415419001	LTO 4.8V 1.2Ah	4320	415401001	NiCd 3.6V 0.75Ah	12184FM	415139000	Pb 6V 4Ah
250ATSAUV	415436001	LiFe 3.2V 1.5Ah	4321	415098001	NiMH 3.6V 1.2Ah	12185	415409001	NiMh 7.2V 2.5Ah
250ATSEUV	415436001	LiFe 3.2V 1.5Ah	4322	415098001	NiMH 3.6V 1.2Ah	12185FM	415409001	NiMh 7.2V 2.5Ah
250SA	415436001	LiFe 3.2V 1.5Ah	4330	415436001	LiFe 3.2V 1.5Ah	12186	415409001	NiMh 7.2V 2.5Ah
250SE	415436001	LiFe 3.2V 1.5Ah	4331	415436001	LiFe 3.2V 1.5Ah	12186FM	415409001	NiMh 7.2V 2.5Ah
250SAUV	415436001	LiFe 3.2V 1.5Ah	4334	415436001	LiFe 3.2V 1.5Ah	12187	415409001	NiMh 7.2V 2.5Ah
250SEUV	415436001	LiFe 3.2V 1.5Ah	4335	415441001	LiFe 3.2V 3Ah	12187FM	415409001	NiMh 7.2V 2.5Ah
500ATSA	415441001	LiFe 3.2V 3Ah	4370	415417001	LTO 4.8V 0.5Ah	1499	415438001	Pb 4V 3Ah
500ATSE	415441001	LiFe 3.2V 3Ah	4371	415420001	LTO 4.8V 1Ah	1499/24	415438001	Pb 4V 3Ah
500ATSAUV	415441001	LiFe 3.2V 3Ah	4372	415417001	LTO 4.8V 0.5Ah	1499L	415441001	LiFe 3.2V 3Ah
500ATSEUV	415441001	LiFe 3.2V 3Ah	4373	415420001	LTO 4.8V 1Ah	1499LUV	415436001	LiFe 3.2V 1.5Ah
500SA	415441001	LiFe 3.2V 3Ah	4380	415423001	LTO 7.2V 0.5Ah	15030	415391001	NiMh 7.2V 1.2Ah
500SE	415441001	LiFe 3.2V 3Ah	4381	415433001	2 x LTO 7.2V 0.5Ah	15032	415444001	LiFe 12.8V 1.5Ah
500SAUV	415441001	LiFe 3.2V 3Ah	4390	415432001	LTO 7.2V 0.5Ah	18400	415436001	LiFe 3.2V 1.5Ah
500SEUV	415441001	LiFe 3.2V 3Ah	4391	415432001	LTO 7.2V 0.5Ah	18401	415433001	2x LTO 7.2V 0.5Ah
824BA	415049103	NiCd 3.6V 0.75Ah	4393	415432001	2 x LTO 7.2V 0.5Ah	19200	415072301	NiCd 3.6V 0.75Ah
824L	415098001	NiMH 3.6V 1.2Ah	4400	415437001	LiFe 3.2V 0.5Ah	19201	415097001	NiMH 3.6V 1.2Ah
824LSA	415098001	NiMH 3.6V 1.2Ah	4401	415436001	LiFe 3.2V 1.5Ah	19202	415072301	NiCd 3.6V 0.75Ah
824M	415049103	NiCd 3.6V 0.75Ah	4402	415441001	LiFe 3.2V 3Ah	19203	415097001	NiMH 3.6V 1.2Ah
824MSA	415049103	NiCd 3.6V 0.75Ah	4403	415437001	LiFe 3.2V 0.5Ah	19204	415072301	NiCd 3.6V 0.75Ah
824S	415049103	NiCd 3.6V 0.75Ah	4404	415436001	LiFe 3.2V 1.5Ah	19205	415097001	NiMH 3.6V 1.2Ah
4101	415072301	NiCd 3.6V 0.75Ah	4405	415441001	LiFe 3.2V 3Ah	19206	415072301	NiCd 3.6V 0.75Ah
4102	415072301	NiCd 3.6V 0.75Ah	4601	415170001	Li-ion 3.2V 0.1Ah	19207	415097001	NiMH 3.6V 1.2Ah
4103	415072301	NiCd 3.6V 0.75Ah	4602	415268001	NiCd 2.4V 0.4Ah	19208	415072301	NiCd 3.6V 0.75Ah
4104	415097001	NiMH 3.6V 1.2Ah	4603	415268001	NiCd 2.4V 0.4Ah	19209	415097001	2 x NiMH 3.6V 1.2Ah
4105	415072301	NiCd 3.6V 0.75Ah	4605	415269001	NiCd 4.8V 0.4Ah	19210	415072301	2 x NiCd 3.6V 0.75Ah
4106	415097001	NiMH 3.6V 1.2Ah	4607	415278000	LiFe 3.2V 0.2Ah	19211	415097001	2 x NiMH 3.6V 1.2Ah
4107	415072301	2 x NiCd 3.6V 0.75Ah	4609	415416001	NiCd 3.6V 0.4Ah	19212	415072301	2 x NiCd 3.6V 0.75Ah
4108	415072301	2 x NiCd 3.6V 0.75Ah	4611	415421001	NiCd 3.6V 0.4Ah	19213	415097001	NiMH 3.6V 1.2Ah
4109	415097001	2 x NiMH 3.6V 1.2Ah	4612	415277001	NiCd 3.6V 0.4Ah	19290	415419001	LTO 4.8V 1.2Ah
4110	415072301	2 x NiCd 3.6V 0.75Ah	8584	415444001	LiFe 9.6V 1.5Ah	19291	415419001	LTO 4.8V 1.2Ah
4111	415097001	2 x NiMH 3.6V 1.2Ah	8585	415444001	LiFe 9.6V 1.5Ah	19292	415419001	2 x LTO 4.8V 1.2Ah
4200	415418001	LTO 4.8V 0.5Ah	8586	415444001	LiFe 9.6V 1.5Ah	19293	415419001	2 x LTO 4.8V 1.2Ah
4201	415418001	LTO 4.8V 0.5Ah	8587	415444001	LiFe 9.6V 1.5Ah	19294	415419001	LTO 4.8V 1.2Ah
4202	415418001	2 x LTO 4.8V 0.5Ah	8590	415444001	LiFe 9.6V 1.5Ah	19295	415419001	2 x LTO 4.8V 1.2Ah
4203	415418001	LTO 4.8V 0.5Ah	8591	415444001	LiFe 9.6V 1.5Ah	19296	415419001	2 x LTO 4.8V 1.2Ah
4204	415418001	2 x LTO 4.8V 0.5Ah	8592	415444001	LiFe 9.6V 1.5Ah	19328	415432001	LTO 7.5V 0.5Ah
4290A	415097001	NiMH 3.6V 1.2Ah	8593	415444001	LiFe 9.6V 1.5Ah	19329	415432001	2 x LTO 7.5V 0.5Ah
4291A	415097001	NiMH 3.6V 1.2Ah	8594	415444001	LiFe 9.6V 1.5Ah	19338	415432001	LTO 7.2V 0.5Ah
4292A	415097001	NiMH 3.6V 1.2Ah	8595	415444001	LiFe 9.6V 1.5Ah	19339	415432001	2 x LTO 7.2V 0.5Ah
4293A	415097001	2 x NiMH 3.6V 1.2Ah	8596	415444001	LiFe 9.6V 1.5Ah	19355L	415444001	LiFe 9.6V 1.5Ah HT
4300	415049103	NiCd 3.6V 0.75Ah	12182	415139000	Pb 6V 4Ah	19358	415414001	NiCd 7.2V 0.75Ah
4301	415098001	NiMH 3.6V 1.2Ah	12182FM	415139000	Pb 6V 4Ah	19359	415415001	NiMH 7.2V 1.5Ah
4302	415399001	NiMh 3.6V 1.5Ah	12183	415139000	Pb 6V 4Ah	19367	415414001	NiCd 7.2V 0.75Ah
4303	415098001	NiMH 3.6V 1.2Ah	12183FM	415139000	Pb 6V 4Ah	19368	415415001	NiMH 7.2V 1.5Ah

Order code Luminaire	Order code battery	Description battery
19370	415419001	2 x LTO 4.8V 1.2Ah
19371	415415001	NiMH 7.2V 1.5Ah
19373	415415001	NiMH 7.2V 1.5Ah
19378	415462001	LiFe 12.8V 3Ah
19390	415439001	LTO 14.4V 1.2Ah
19391	415440001	LiFe 12.8V 1.5Ah HT
19410	415442001	2 x LTO 9.6V 1.2Ah
19411	415442001	2 x LTO 9.6V 1.2Ah
19420	415443001	2 x LTO 9.6V 0.5Ah
19421	415442001	2 x LTO 9.6V 1.2Ah
19430	415444001	LiFe 9.6V 1.5Ah
19430UV	415419001	2x LTO 4.8V 1.2Ah
19431	415444001	LiFe 9.6V 1.5Ah
19431UV	415419001	2x LTO 4.8V 1.2Ah
19432	415444001	LiFe 9.6V 1.5Ah
19432UV	415419001	2x LTO 4.8V 1.2Ah
19433	415444001	LiFe 9.6V 1.5Ah
19433UV	415419001	2x LTO 4.8V 1.2Ah
19434	415444001	LiFe 9.6V 1.5Ah
19435	415444001	LiFe 9.6V 1.5Ah
19450	415418001	LTO 4.8V 0.5Ah
19450UV	415418001	LTO 4.8V 0.5Ah
19451	415419001	LTO 4.8V 1.2Ah
19451UV	415419001	LTO 4.8V 1.2Ah
19452	415418001	LTO 4.8V 0.5Ah
19452UV	415418001	LTO 4.8V 0.5Ah
19453	415419001	LTO 4.8V 1.2Ah
19453UV	415419001	LTO 4.8V 1.2Ah
19454	415419001	2 x LTO 4.8V 1.2Ah
19455	415419001	2 x LTO 4.8V 1.2Ah
19460	415419001	2 x LTO 4.8V 1.2Ah
19460UV	415419001	2 x LTO 4.8V 1.2Ah
19461	415419001	2 x LTO 4.8V 1.2Ah
19470	415442001	2 x LTO 9.6V 1.2Ah
19471	415442001	2 x LTO 9.6V 1.2Ah
19600	415437001	LiFe 3.2V 0.5Ah
19601	415457001	LiFe 3.2V 1.5Ah
19602	415437001	LiFe 3.2V 0.5Ah
19603	415457001	LiFe 3.2V 1.5Ah
19620	415417001	LTO 4.8V 0.5Ah
19621	415420001	LTO 4.8V 1Ah
19622	415417001	LTO 4.8V 0.5Ah
19623	415420001	LTO 4.8V 1Ah
19700	415436001	LiFe 3.2V 1.5Ah
19711	415432001	2 x LTO 7.2V 0.5Ah
19712	415440001	LiFe 12.8V 1.5Ah

Order code Luminaire	Order code battery	Description battery
19800	415436001	LiFe 3.2V 1.5Ah
19801	415436001	LiFe 3.2V 1.5Ah
19802	415436001	LiFe 3.2V 1.5Ah
19803	415436001	LiFe 3.2V 1.5Ah
19810	415433001	LTO 7.2V 0.5AH
19811	415433001	2 x LTO 7.2V 0.5Ah
19812	415433001	LTO 7.2V 0.5AH
19813	415433001	2 x LTO 7.2V 0.5Ah
37126	415432001	2 x LTO 7.2V 0.5Ah
37127	415432001	2 x LTO 7.2V 0.5Ah
37128	415432001	2 x LTO 7.2V 0.5Ah
37236	415432001	2 x LTO 7.2V 0.5Ah
37237	415432001	2 x LTO 7.2V 0.5Ah
37238	415432001	2 x LTO 7.2V 0.5Ah
81143	81296E	Li-ion 3.7V 0.5Ah
81144	81296E	Li-ion 3.7V 0.5Ah
R0818	415072301	NiCd 3.6V 0.75Ah
R1124	415072301	NiCd 3.6V 0.75Ah
R1124SA	415072301	NiCd 3.6V 0.75Ah
R2436	415097001	NiMH 3.6V 1.2Ah
R2436SA	415097001	NiMH 3.6V 1.2Ah

# General terms and conditions of sale

## 1. ORDERS - FINALISATION OF AGREEMENTS

Product purchase orders shall be formulated in writing. Order placement is deemed irrevocable. All collaboration programs, orders, work orders and agreements are considered finalised by the written or verbal confirmation of the Seller or, however, as soon as the invoicing and/or delivery of the ordered products is initiated.

## 2. VARIANTS AND MODIFICATIONS

After order finalisation, any modification or addition to the content and conditions of the order shall be valid and will become effective only after the Buyer receives a confirmation variant from the Seller. The text of the Seller's confirmation or confirmation variant shall in all cases prevail over any other document. If the Buyer does not intend to accept the conditions that differ from his/her order, he/she must inform the Seller within 20 (twenty) days from the date of confirmation; otherwise, the confirmation variant will be considered fully accepted.

## 3. METHOD OF ACCEPTANCE

The Seller shall not be held liable for any unaccepted orders or for any failed or delayed delivery of the products part thereof. Acceptance and execution of the order are specifically subject to the availability of the products ordered as well as the absence of circumstances that may affect the availability of the same and the timeliness of their delivery.

## 4. TERMS OF DELIVERY

The delivery terms communicated by the Seller are purely indicative. Delivery terms expressed in days are normally counted in working days. Any changes to the delivery terms requested by the Buyer must be first accepted in writing by the Seller. Any delay in deliveries, as well as any interruption and/or total or partial suspension of supplies, even if not due to force majeure and/or accidental circumstances, will not entitle the Buyer to compensation for damages and/or to any other kind of indemnity or interest, except for the sole right to cancel the order, provided that the Seller is notified in advance, with at least thirty days before the day of receipt of the registered letter with acknowledgement of receipt sent by the Buyer.

## 5. FORCE MAJEURE

By way of example, but not limited to, the following are considered cases of force majeure: strikes, lockouts, riots, labour conflicts, fires, natural disasters, impossibility of supplying products, interruptions or difficulties in transport, delays of shipment, lack of raw materials, government acts, authority measures, contractual non-fulfilment by suppliers and, in general, any unforeseeable event that is outside the reasonable control of the Seller. In all such cases, as well as in the event of any accidental circumstances, the Seller reserves the right to suspend and/or delay the delivery of the products and even cancel the orders, even if already confirmed; this will not entitle the Buyer to compensation for damages and/or to any other kind of indemnity, including those for direct, indirect and consequential loss.

## 6. DELIVERY - TRANSPORT

The goods always travel at the risk and danger of the Buyer, even if delivered carriage paid and/or using a vehicle of the Seller; therefore, the Seller will not accept disputes for any product breakage and/or tampering. The delivery of the products is intended to be carried out at the Seller's headquarters in Montevoglio - Valsamoggia (Bologna) or at third party warehouses with which the Seller has entered into special agreements ("Ex works" condition - Incoterms 2010). Transport costs are borne by the Buyer. The Seller does not accept returns.

## 7. COMPLAINTS - PRODUCT REPLACEMENT

Any requests for replacement and complaints shall be handled by applying the safeguards provided by the applicable legislation in relation to the specific type of customer, professional operator or consumer. Upon product receipt, the Buyer must check its condition, the quantity delivered and its compliance with the delivery note. Any complaints concerning product quality, quantity or type shall be submitted in writing within 8 (eight) days from the date of receipt of the goods. After this period, without prejudice to the warranty conditions provided for the individual products, no claim can be made regarding the material and quality of the goods, or their condition in general. The Buyer may not, under any circumstances, return the products without the prior written authorisation of the Seller, nor delay and/or suspend the payment of invoices in whole or in part, not even in the case of complaints. If, in the opinion of the Seller, the claim is justified and has been filed within the warranty terms stated in the booklets accompanying the individual products, the obligation of the latter is limited only to the replacement of the nonconforming product in accordance with the delivery terms established for the first delivery. It is, therefore, excluded any right of the Buyer to cancel the order or to obtain any compensation for expenses and/or damages. The right to replace

the contested product shall lapse if the product is not diligently stored, kept at the disposal of the Seller, and returned immediately to the place determined by the Seller.

## 8. APPLICATION OF WARRANTY

The warranty applies only to faults and/or defects in the conformity of the product in relation to the terms and conditions indicated in the declared and/or agreed technical specifications or in case of premature breakage of one of its parts. The validity period of the aforementioned warranty is at least 24 months from the date of purchase, which can be proved by presenting a valid tax document. Luminaires with extended warranties are marked in catalogues or instruction sheets with the number of years of total warranty in conjunction with the letter G (e.g., 5G marking for products with a 5-year warranty). As a general rule, the following extensions apply: emergency luminaires equipped with Lithium Iron batteries (LiFe) and centralised emergency lighting systems benefit from a 5-year warranty, those equipped with Lithium Titanate batteries (LTO) benefit from a 10-year warranty (for all parts, including batteries); EcoDriver or Dimmable luminaires benefit from a 3-year warranty, SmartDriver luminaires benefit from a 5-year warranty (for all parts, including sources). The warranty does not apply in case of tampering, to defects caused by accidental damage of any kind, including during transport and installation, in case of improper use or use in disagreement with the product specifications, in case of negligence in use and maintenance, errors in installation or connection, and installation performed by unqualified personnel or without respecting the state-of-the-art standards. Unless otherwise required by applicable law, the warranty is limited only to the replacement/repair of nonconforming products or parts, according to the delivery terms of the first delivery. All work performed under warranty by the Seller shall be subject to observance of the payment conditions by the Buyer.

## 9. PRICES

The prices indicated in the Seller's price lists are not binding; therefore, the Seller reserves the right to modify them until the time of delivery of the products. All prices are exclusive of VAT and any other tax charges.

## 10. PAYMENTS

All payments shall be made, within the terms and in the manner indicated by the Seller, to its headquarters in Montevoglio - Valsamoggia (Bologna) or to the appointed person authorised in writing by the Seller. In case of delay in payment, the defaulting buyer will be obliged to pay the Seller interests on late payment from the date of expiry of the contractual period until settlement, to the extent provided for in Legislative Decree 231/2002, apart from any compensation for any further damages incurred. Failure to comply with the payment terms by the Buyer will give the Seller the right to terminate the corresponding supply contract with immediate effect and to suspend the delivery of all products ordered without the need for any communication, with the consequent right of the Seller to demand the immediate payment of the entire credit as well as to claim compensation for the damages incurred. In case of non-fulfilment and/or worsening of the patrimonial conditions of the Buyer to a degree that may jeopardise the collection of the credit by the Seller, as well as in the event of prolonged delay in payments and/or high total debt exposure (also due to previous uncollected sales), the Seller reserves the right to apply the provisions of art. 1460 and 1461 CC, undertake appropriate precautionary actions and resort to any other form of self-protection permitted; it is further agreed that in such cases the Seller may suspend any and all supplies.

## 11. LIEN AGREEMENT

The products sold are subject to a lien agreement; therefore, the Seller will retain possession of the goods sold until their price is paid in full. The Buyer, therefore, undertakes to inform third parties of the existence and effectiveness of this Lien Agreement, as well as to safeguard the Seller's rights deriving from the same.

## 12. SAFEGUARDING – DISPUTES AND JURISDICTION

The invalidity or unenforceability of any of the clauses contained in these general conditions of sale shall not affect, or detract from the validity and enforceability of the other provisions; the Seller and the Buyer undertake to replace any clauses declared ineffective and/or null, or impracticable, with other provisions having similar effects. For any dispute or contestation relating to the interpretation, validity and execution of the order or, in any case, concerning the contracts to which these general conditions of sale apply shall be governed by the Italian Law. The Forum of Bologna shall have exclusive jurisdiction.

# Product safety and European Directives

## PRODUCT SAFETY AND EUROPEAN DIRECTIVES

Beghelli products are manufactured according to the state-of-the-art standards concerning safety and quality and will not affect, even when used under foreseeable overload conditions, the safety of persons, pets and property, on condition that they are correctly installed and used according to their intended purpose in the recommended environmental conditions and subject to proper maintenance by qualified personnel.

To the extent applicable, the products shall be manufactured in accordance with the requirements of Community Directives 2014/35/EU, 2014/30/EU, 2014/53/EU, 2014/30/EU, 2009/125/CE, 2001/65/CE.

The CE marking affixed to the product and/or packaging and/or any warnings of use accompanying the product attest to the conformity of the product with the aforementioned Directives. Beghelli has its own Technical Archive, available to the competent authorities for possible inspections, containing documentation demonstrating that the product has been examined to assess its compliance.

Products that do not fall within the scope of the above-mentioned EC Directives comply with the quality standards laid down by the regulations in force and by Directive 2001/95/CE ("General Product Safety Directive"), transposed by Legislative Decree No. 172/2004.

The data contained in this catalogue may be subject to change without notice.

The indications, dimensions, drawings and photos of the products and components are given for informational purposes only and may be modified without prior notice, as they do not constitute pre-contractual information. All products intended to be connected to the mains shall be installed in compliance with the installation standards in force in the country of use, observing the information contained in the Catalogue and/or the relevant instructions supplied with the product itself.

# Environmental protection

## WEEE DIRECTIVE 2012/19/EU

The quantities of waste from electrical and electronic equipment (WEEE) are rapidly increasing; most of the light sources are included in this category.

The main aim of the directive is to prevent WEEE from being discarded to landfills or incinerators at the end of their life, thereby causing further serious environmental impact.

Directive 2012/19/EU, therefore, sought to induce a control mechanism which provides for a controlled end-of-life management of the device by giving priority to its reuse or recycling. In addition, the legislative mechanism promotes design and production concepts that make it easier to dispose of the products in terms of both their disassembly and their materials.

All supply chain participants are invited to make their own contribution, some with regard to the economic aspects, some in terms of activity, so that the spirit of the directive is respected (and the environment is protected).

In Italy, the Directive has been transposed by Legislative Decree No. 49 of 14 March 2014.

## THESE ARE THE MAIN OBLIGATIONS FORESEEN

The manufacturer (understood in a broad sense and, therefore, essentially as the person who affixes one's own brand on the goods and who imports them from third countries) is responsible for the costs of disposing of their products at the end of their life.

The consumer is required to guarantee an intelligent end-of-life management of the product by sending it to a specially equipped site, a point of sale or by observing the instructions provided by the manufacturer.

Beghelli, always sensitive to environmental issues, is one of the founding members of the ECOLIGHT consortium.

Choosing products from companies that have joined voluntary consortia for the recovery and recycling of goods is the responsible and ecologically correct choice to protect the environment and our future.

Products falling under the scope of the WEEE Directive are identified by this symbol.



## ROHS DIRECTIVE 2011/65/UE

In order to facilitate the recovery and recycling of electrical equipment and to prevent hazardous substances from accumulating into the environment, the European Community has enacted the ROHS Directive. Essentially, this Directive states that:

Without prejudice to Annex 3, the placing on the market of new electrical and electronic equipment falling within the categories identified in Annex 1 containing lead, mercury, cadmium, hexavalent chromium, polybrominated biphenyls (PBB) or polybrominated diphenyl ether (PBDE) in excess of the value indicated in Annex 2, shall be prohibited.

In Italy, the Directive has been transposed by Legislative Decree No. 27 of 4 March 2014.

The technical data and images in this catalogue are subject to continuous development and may change without notice. To check the latest technical update of the luminaires, please refer to the electronic catalogue on [www.beghelli.com](http://www.beghelli.com).

Digital catalogues of the various product ranges are also available on the website and can also be requested in hard copy from:  
BEGHELLI S.p.A. - Commercial Division - Via Mozzeghine, 13/15  
Valsamoggia Loc. Monteveglio - 40053 BO

© Copyright 06/2021



BEGHELLI S.p.A. Via Mozzeghine 13/15 - 40053 Valsamoggia loc. Monteveglio  
Bologna - Italy - Tel. +39 051 9660411 - [info@beghelli.it](mailto:info@beghelli.it) - [www.beghelli.com](http://www.beghelli.com)