



## QUADER

Housing made of sheet steel in square shape with cuboid, opal cover. 1-, 2- or 3-sided escape route indication through self-adhesive foils.

Versions for surface ceiling mounting and with additional accessories for pendulum and chain/wire

### MOUNTING TYPES

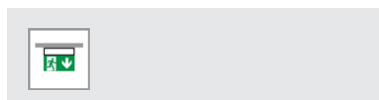

### MOUNTING TYPES WITH ACCESSORIES



### TECHNICAL DATA

<b>Housing:</b>	Sheet steel, white (RAL 9003)	<b>Color stability:</b>	3 SDCM
<b>Cover:</b>	PMMA, opal	<b>Color temperature:</b>	4.000 K
<b>Foil:</b>	PVC, printed	<b>Color rendering index:</b>	70
<b>Service life <math>L_{80}B_{20}</math>:</b>	50.000 h	<b>Optic interface:</b>	LIFE



**Commissioning:** For Autotest, operating duration, operating mode PS, monitoring group and test duration are only programmable per app B.connect over smartphone locally on luminaire.

### SELF-CONTAINED SUPPLY

<b>Mains supply:</b>	198 V – 254 V/50 Hz
<b>Switching:</b>	Maintained and non-maintained
<b>Ambient temperature:</b>	0 °C to +40 °C
<b>Protection class:</b>	I

### DECENTRAL SUPPLY

<b>Mains supply:</b>	24 V +/- 20 % DC
<b>Battery supply:</b>	24 V +/- 20 % DC
<b>Ambient temperature:</b>	-20 °C to +40 °C
<b>Protection class:</b>	III



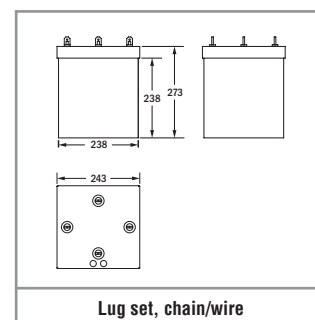
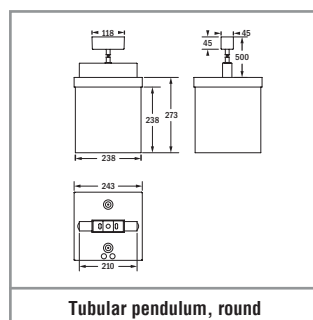
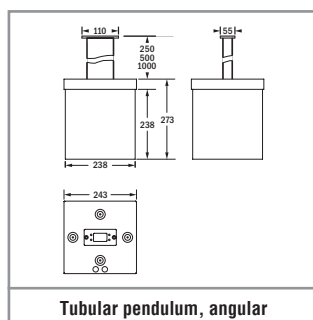
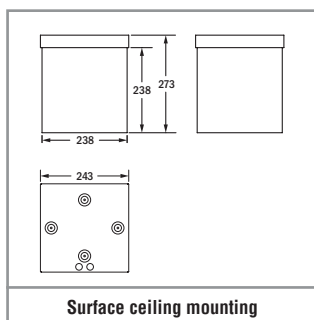

### CENTRAL SUPPLY

<b>Mains supply:</b>	198 V – 254 V/50 Hz
<b>Battery supply:</b>	176 V – 276 V
<b>Ambient temperature:</b>	-20 °C to +40 °C
<b>Protection class:</b>	I
<b>Mains supply (alt.):</b>	90 V – 254 V / 50/60 Hz
<b>Battery supply (alt.):</b>	90 V – 276 V





## LIFE SELF-CONTAINED SUPPLY





10 YEARS GUARANTEE

Autotest / CableCom Order code	Logica Order code	Logica FM Order code		LED 	t 		S~ 
Surface ceiling mounting (3-sided escape route indication) <sup>1</sup>							
37072	37073	37074	44 m	2	1 h / 3 h / 8 h	LIFE 6.4 V / 1.5 Ah	8 VA

## SICURO<sup>LED</sup> DECENTRAL SUPPLY





Sicuro24 Order code		LED 	P= 
Surface ceiling mounting (3-sided escape route indication) <sup>1</sup>			
32024	22 m / 44 m	2	4.3 W

## SICURO<sup>LED</sup> CENTRAL SUPPLY

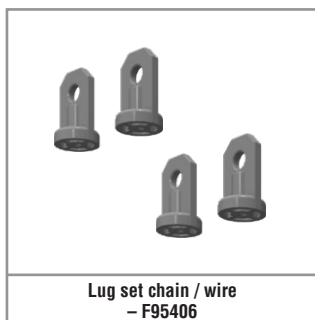
Sicuro230 Order code		LED 	S~ 	P= 
Surface ceiling mounting (3-sided escape route indication) <sup>1</sup>				
31024	22 m / 44 m	2	9.4 VA / 4.7 W	

<sup>1</sup> Please order additional required accessories for pendulum and chain/wire separately. The pendulum mounting adaptor is required for all types of pendulums.



Please order escape sign accessories separately			
Order code	Description		
VD 22 m	VD 44 m		
F15330M	F15325M	Escape sign foil	
F15331M	F15326M	Escape sign foil	
F15332M	F15327M	Escape sign foil	
F15329M	F15328M	Escape sign foil	

Please order accessories separately	
Order code	Description
F95210	Pendulum mounting adaptor
F95600	Tubular pendulum, angular, 250 mm
F95601	Tubular pendulum, angular, 500 mm
F95602	Tubular pendulum, angular, 1.000 mm
F95400	Tubular pendulum, round, 500 mm
F95406	Lug set for chain and wire mounting