

Downlight System



IP20
IP54

IK05

850°

+40°C
-20°C

CRI>90

75°

55°

45°



Technické parametry

Jmenovité napětí 230 V_{AC} ±10 %, 50–60 Hz

Pokles světelného toku při 25 °C

>50 000 h (L70B20)

Montáž vestavná, do sádkkartonu

Těleso tlakový odlitek z hliníku

Optika PMMA

Difuzér 75° se světelným filtrem, 55° bez světelného filtru, 45° se zrcadlovým reflektorem

Normy ČSN EN 60598-1, ČSN EN 60598-2-2, ČSN EN 60598-2-22, ČSN EN 62471, CAM minimální environmentální kritéria podle DM 11.01.2017, 2014/53/EU

Aplikace

terciární sektor, civilní sektor, hotely, školy, nemocnice

Characteristics

Power supply 230 V AC ±10 %, 50–60 Hz

Luminous flux retention at 25 °C

>50,000 h (L70B20)

Mounting recessed, plasterboard

Housing die-cast aluminium

Optics PMMA

Screen 75° with light filter, 55° without light filter, 45° with specular reflector

Compliance EN 60598-1, EN 60598-2-2, EN 60598-2-22, EN 62471, CAM Minimum Environmental Criteria according to DM 11.01.2017, 2014/53/EU

Applications

residential, services sector, hotels, schools, hospitals

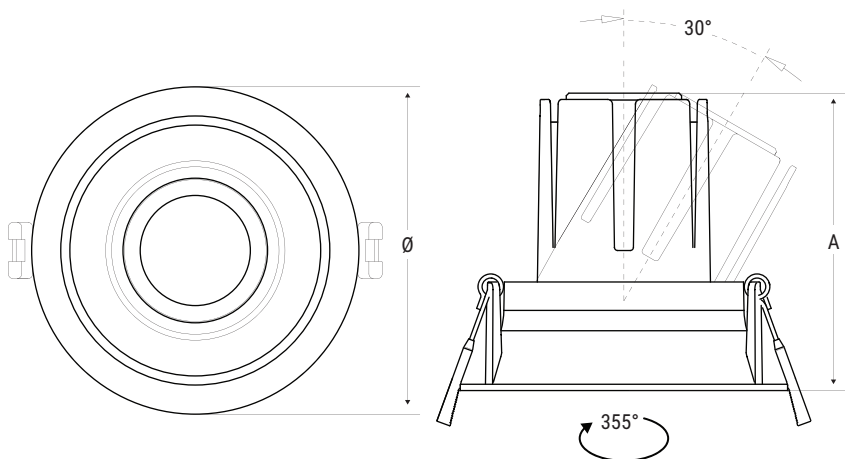

W	Rozměry Dimensions mm		Montážní otvor Recessed hole mm Ø
	A	Ø	
15	95	104	95
24	117	125	110
32	138	145	130
42	152	165	150

75° SE SVĚTELNÝM FILTREM / WITH LIGHT FILTER

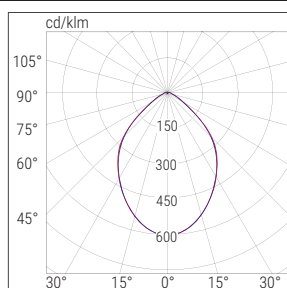

■ C90-C270 ■ C0-C180

Napájecí jednotka

a zdroj LED jsou vybaveny hliníkovým chladičem a čočkovitou optikou
Power supply unit and LED source equipped with aluminum heat sink and lenticular optics



55° BEZ FILTRU / WITHOUT FILTER

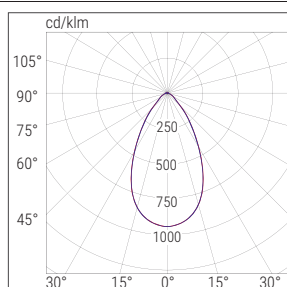

■ C90-C270 ■ C0-C180

Těleso svítidla

s úchytným systémem a nastavitelným rámem pro natočení světelného paprsku až o 30°
Luminaire body with fixing system and adjustable frame to tilt the beam up to 30°



45° ZRCADLOVÝ REFLEKTOR / SPECULAR REFLECTOR

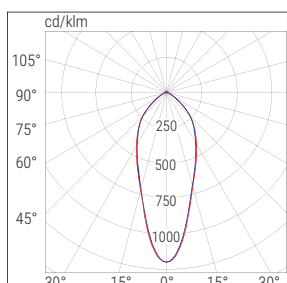

■ C90-C270 ■ C0-C180

Reflektor

Leštěný titanový saténový kov – zrcadlový kov – matná bílá
Reflector
 Polished titanium
 Satin metal – Specular metal – Matt white



Kód Code	Popis Description	Příkon Power W	Teplota chrom. Colour Temp. K	CRI	Svět. tok LED LED Flux lm (Tj=25°C)	Svět. tok Flux lm	lm/W	Kg	Pozn. Notes
SATÉNOVÁ OPTIKA / SATIN OPTICS									
40330	DWL 15W 75° C90 SAT RD 4K	15	4000	>90	1900	1650	110	0.4	
40331	DWL 24W 75° C90 SAT RD 4K	24	4000	>90	3100	2640	110	0,7	
40332	DWL 32W 75° C90 SAT RD 4K	32	4000	>90	4100	3500	110	1	
40333	DWL 41W 75° C90 SAT RD 4K	41	4000	>90	5200	4510	110	1.4	
40360	DWL 15W 75° C90 SAT RD 3K	15	3000	>90	1900	1600	105	0.4	
40361	DWL 24W 75° C90 SAT RD 3K	24	3000	>90	3000	2600	105	0,7	
40362	DWL 32W 75° C90 SAT RD 3K	32	3000	>90	4000	3400	105	1	
40363	DWL 41W 75° C90 SAT RD 3K	41	3000	>90	5000	4300	105	1.4	

RD

NASTAVITELNÉ / ADJUSTABLE

067 downlighty / downlights

Downlight System

Kód Code	Popis Description	Příkon Power W	Teplota chrom. Colour Temp. K	CRI	Svět. tok LED LED Flux lm (Tj=25°C)	Svět. tok Flux lm	lm/W	Kg	Pozn. Notes
BÍLÁ OPTIKA / WHITE OPTICS									
40334	DWL 15W 75° C90 IP54 BIANCO RD 4K	15	4000	>90	1900	1650	110	0,4	
40335	DWL 24W 75° C90 IP54 BIANCO RD 4K	24	4000	>90	3100	2640	110	0,7	
40336	DWL 32W 75° C90 IP54 BIANCO RD 4K	32	4000	>90	4100	3500	110	1	
40337	DWL 41W 75° C90 IP54 BIANCO RD 4K	41	4000	>90	5200	4510	110	1,4	
40364	DWL 15W 75° C90 IP54 BIANCO RD 3K	15	3000	>90	1900	1600	105	0,4	
40365	DWL 24W 75° C90 IP54 BIANCO RD 3K	24	3000	>90	3000	2600	105	0,7	
40366	DWL 32W 75° C90 IP54 BIANCO RD 3K	32	3000	>90	4000	3400	105	1	
40367	DWL 41W 75° C90 IP54 BIANCO RD 3K	41	3000	>90	5000	4300	105	1,4	
ZRCADLOVÁ OPTIKA / SPECULAR OPTICS									
40388	DWL 15W 45° C90 IP54 BRILLA RD 4K	15	4000	>90	1900	1650	110	0,4	
40389	DWL 24W 45° C90 IP54 BRILLA RD 4K	24	4000	>90	3100	2640	110	0,7	
40390	DWL 32W 45° C90 IP54 BRILLA RD 4K	32	4000	>90	4100	3500	110	1	
40391	DWL 41W 45° C90 IP54 BRILLA RD 4K	41	4000	>90	5200	4510	110	1,4	
40440	DWL 15W 45° C90 IP54 BRILLA RD 3K	15	3000	>90	1900	1600	105	0,4	
40441	DWL 24W 45° C90 IP54 BRILLA RD 3K	24	3000	>90	3000	2600	105	0,7	
40442	DWL 32W 45° C90 IP54 BRILLA RD 3K	32	3000	>90	4000	3400	105	1	
40443	DWL 41W 45° C90 IP54 BRILLA RD 3K	41	3000	>90	5000	4300	105	1,4	
SATÉNOVÁ OPTIKA / SATIN OPTICS									
40340	DWL 15W 75° C90 IP54 SAT DL 4K	15	4000	>90	1900	1650	110	0,4	
40341	DWL 24W 75° C90 IP54 SAT DL 4K	24	4000	>90	3100	2640	110	0,7	
40342	DWL 32W 75° C90 IP54 SAT DL 4K	32	4000	>90	4100	3500	110	1	
40343	DWL 41W 75° C90 IP54 SAT DL 4K	41	4000	>90	5200	4510	110	1,4	
40370	DWL 15W 75° C90 IP54 SAT DL 3K	15	3000	>90	1900	1600	105	0,4	
40371	DWL 24W 75° C90 IP54 SAT DL 3K	24	3000	>90	3000	2600	105	0,7	
40372	DWL 32W 75° C90 IP54 SAT DL 3K	32	3000	>90	4000	3400	105	1	
40373	DWL 41W 75° C90 IP54 SAT DL 3K	41	3000	>90	5000	4300	105	1,4	
BÍLÁ OPTIKA / WHITE OPTICS									
40344	DWL 15W 75° C90 IP54 BIANCO DL 4K	15	4000	>90	1900	1650	110	0,4	
40345	DWL 24W 75° C90 IP54 BIANCO DL 4K	24	4000	>90	3100	2640	110	0,7	
40346	DWL 32W 75° C90 IP54 BIANCO DL 4K	32	4000	>90	4100	3500	110	1	
40347	DWL 41W 75° C90 IP54 BIANCO DL 4K	41	4000	>90	5200	4510	110	1,4	
40374	DWL 15W 75° C90 IP54 BIANCO DL 3K	15	3000	>90	1900	1600	105	0,4	
40375	DWL 24W 75° C90 IP54 BIANCO DL 3K	24	3000	>90	3000	2600	105	0,7	
40376	DWL 32W 75° C90 IP54 BIANCO DL 3K	32	3000	>90	4000	3400	105	1	
40377	DWL 41W 75° C90 BIANCO DL 3K IP54	41	3000	>90	5000	4300	105	1,4	
ZRCADLOVÁ OPTIKA / SPECULAR OPTICS									
40392	DWL 15W 45° C90 IP54 BRILLA DL 4K	15	4000	>90	1900	1650	110	0,4	
40393	DWL 24W 45° C90 IP54 BRILLA DL 4K	24	4000	>90	3100	2640	110	0,7	
40394	DWL 32W 45° C90 IP54 BRILLA DL 4K	32	4000	>90	4100	3500	110	1	
40395	DWL 41W 45° C90 IP54 BRILLA DL 4K	41	4000	>90	5200	4510	110	1,4	
40444	DWL 15W 45° C90 IP54 BRILLA DL 3K	15	3000	>90	1900	1600	105	0,4	
40445	DWL 24W 45° C90 IP54 BRILLA DL 3K	24	3000	>90	3000	2600	105	0,7	
40446	DWL 32W 45° C90 IP54 BRILLA DL 3K	32	3000	>90	4000	3400	105	1	
40447	DWL 41W 45° C90 IP54 BRILLA DL 3K	41	3000	>90	5000	4300	105	1,4	

NASTAVITELNĚ / ADJUSTABLE

DALI

Kód Code	Popis Description	Příkon Power W	Teplota chrom. Colour Temp. K	CRI	Svět. tok LED LED Flux lm (Tj=25°C)	Svět. tok Flux lm	lm/W	Kg	Pozn. Notes
SATÉNOVÁ OPTIKA / SATIN OPTICS									
40350	DWL 15W 75° C90 IP54 SAT SDB 4K	15	4000	>90	1900	1650	110	0,4	
40351	DWL 24W 75° C90 IP54 SAT SDB 4K	24	4000	>90	3100	2640	110	0,7	
40352	DWL 32W 75° C90 IP54 SAT SDB 4K	32	4000	>90	4100	3500	110	1	
40353	DWL 41W 75° C90 IP54 SAT SDB 4K	41	4000	>90	5200	4510	110	1,4	
40380	DWL 15W 75° C90 IP54 SAT SDB 3K	15	3000	>90	1900	1600	105	0,4	
40381	DWL 24W 75° C90 IP54 SAT SDB 3K	24	3000	>90	3000	2600	105	0,7	
40382	DWL 32W 75° C90 IP54 SAT SDB 3K	32	3000	>90	4000	3400	105	1	
40383	DWL 41W 75° C90 IP54 SAT SDB 3K	41	3000	>90	5000	4300	105	1,4	
BÍLÁ OPTIKA / WHITE OPTICS									
40354	DWL 15W 75° C90 IP54 BIANCO SDB 4K	15	4000	>90	1900	1650	110	0,4	
40355	DWL 24W 75° C90 IP54 BIANCO SDB 4K	24	4000	>90	3100	2640	110	0,7	
40356	DWL 32W 75° C90 IP54 BIANCO SDB 4K	32	4000	>90	4100	3500	110	1	
40357	DWL 41W 75° C90 IP54 BIANCO SDB 4K	41	4000	>90	5200	4510	110	1,4	
40384	DWL 15W 75° C90 IP54 BIANCO SDB 3K	15	3000	>90	1900	1600	105	0,4	
40385	DWL 24W 75° C90 IP54 BIANCO SDB 3K	24	3000	>90	3000	2600	105	0,7	
40386	DWL 32W 75° C90 IP54 BIANCO SDB 3K	32	3000	>90	4000	3400	105	1	
40387	DWL 41W 75° C90 IP54 BIANCO SDB 3K	41	3000	>90	5000	4300	105	1,4	
ZRCADLOVÁ OPTIKA / SPECULAR OPTICS									
40396	DWL 15W 45° C90 IP54 BRILLA SDB 4K	15	4000	>90	1900	1650	110	0,4	
40397	DWL 24W 45° C90 IP54 BRILLA SDB 4K	24	4000	>90	3100	2640	110	0,7	
40398	DWL 32W 45° C90 IP54 BRILLA SDB 4K	32	4000	>90	4100	3500	110	1	
40399	DWL 41W 45° C90 IP54 BRILLA SDB 4K	41	4000	>90	5200	4510	110	1,4	
40448	DWL 15W 45° C90 IP54 BRILLA SDB 3K	15	3000	>90	1900	1600	105	0,4	
40449	DWL 24W 45° C90 IP54 BRILLA SDB 3K	24	3000	>90	3000	2600	105	0,7	
40450	DWL 32W 45° C90 IP54 BRILLA SDB 3K	32	3000	>90	4000	3400	105	1	
40451	DWL 41W 45° C90 IP54 BRILLA SDB 3K	41	3000	>90	5000	4300	105	1,4	

RD NASTAVITELNÝ SVĚTELNÝ TOK – PŘÍKON / ADJUSTABLE FLUX-POWER



KROK / STEP 1

KROK / STEP 2



KROK / STEP 3

KROK / STEP 4

Svět. tok / Příkon Flux / Power	15 W			24 W			32 W			41 W		
	lm	W	lm/W	lm	W	lm/W	lm	W	lm/W	lm	W	lm/W
KROK / STEP 1	1650	15	110	2640	24	110	3250	32	110	4510	41	110
KROK / STEP 2	1414	13	110	2420	22	110	3300	30	110	4295	39	110
KROK / STEP 3	1179	11	110	2200	20	110	3080	28	110	4080	37	110
KROK / STEP 4	707	6	110	1980	18	110	2860	26	110	3866	35	110

Verze RD je vybavena spínačem se 3 kroky regulace proudu pro zajištění maximální světelné efektivity a tudíž i maximální úspory energie, kdy se používá pouze světelný tok určený v projektové fázi.

RD driver equipped with a switch with 3 steps of current modulation in order to ensure maximum luminous efficiency, and therefore maximum energy saving, using only the luminous flux determined in the design phase.

Downlight System

osvětlení / lighting

PŘÍSLUŠENSTVÍ – nutno objednat zvlášť / **ACCESSORIES** – to be ordered separately



TITANOVÝ REFLEKTOR
TITANIUM REFLECTOR

15 W – Kód / Code **40460** 24 W – Kód / Code **40461**
32 W – Kód / Code **40462** 41 W – Kód / Code **40463**

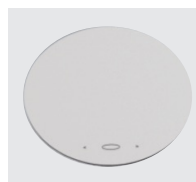

ELIPTICKÝ FILTR
ELLIPTIC FILTER

15W – Kód / Code **40468** 24 W – Kód / Code **40469**
32 W – Kód / Code **40470** 41 W – Kód / Code **40471**



PLÁSTVOVÝ FILTR
HONEYCOMB FILTER

15 W – Kód / Code **40464** 24 W – Kód / Code **40465**
32 W – Kód / Code **40466** 41 W – Kód / Code **40467**

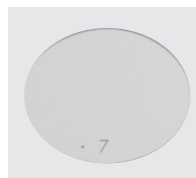

ASYMETRICKÝ FILTR
ASYMMETRICAL FILTER

15W – Kód / Code **40472** 24 W – Kód / Code **40473**
32 W – Kód / Code **40474** 41 W – Kód / Code **40475**



DVOJITÝ ASYMETRICKÝ FILTR
DOUBLE ASYMMETRICAL FILTER

15 W – Kód / Code **40476** 24 W – Kód / Code **40477**
32 W – Kód / Code **40478** 41 W – Kód / Code **40479**



ADAPTÉR / ADAPTER

Ø195–220 mm

24W – Kód / Code **40480**
32W – Kód / Code **40481**
41W – Kód / Code **40482**

NOUZOVÉ VERZE S LED INVERTEREM – nutno objednat zvlášť
EMERGENCY LED INVERTER – to be ordered separately



INVERTER PLUG&LIGHT SE/SA 20–60 V

1 h – Kód / Code **19358**
3 h – Kód / Code **19359**

TR



MODUL / MODULE LG – LGFM – DALI

Pouze pro invertery CT / For CT Inverters only

LG – Kód / Code **15079**
LGFM – Kód / Code **15037**
DALI – Kód / Code **15080**

LG

LGFM

DALI



INVERTER UNIVERSALE 5 W 20–240 V

AT – Kód / Code **19398**
CT – Kód / Code **19399**

AT CT

SD PŘÍSLUŠENSTVÍ – nutno objednat zvlášť / ACCESSORIES – to be ordered separately



ŘÍDICÍ JEDNOTKA LOGICA
LOGICA CONTROL UNIT

SD LGFM – Kód / Code 21102





RADIO MODUL
RADIO MODULE

Kód / Code 15054





KONCENTRÁTOR WIFI BLUETOOTH
WiFi BLUETOOTH CONCENTRATOR
1 ovládací vstup / 1 control input

Kód / Code 15064 



MODUL ROZHRANÍ BLUETOOTH
BLUETOOTH MODULE INTERFACE
3 ovládací vstupy / 3 control inputs

Kód / Code 15065 



SENZOR POHYBU
MOTION SENSOR

IP65 – Kód / Code 15063
IP40 – Kód / Code 15062



KONCENTRÁTOR BLUETOOTH EASY BOX
BLUETOOTH EASY BOX CONCENTRATOR

WiFi – Kód / Code 15174
WiFi ETHERNET – Kód / Code 15074 

Integrovaný systém bezdrátového přenosu pro komunikaci mezi svítidly pro vytváření skupin se stejnými příkazy bez nutnosti přidávat další kabely. Při použití modulu rozhraní Bluetooth je možné ovládat skupiny bezdrátově. Pro správu centralizovaného systému pomocí aplikace B.connect musí být nainstalován koncentrátor Bluetooth.

Integrated wireless transmission system for communication between luminaires in order to create groups with the same commands without adding further wiring. Using the Bluetooth Interface Module it is possible to control the groups wireless. To manage a centralized system from the B.connect APP, the Bluetooth concentrator must be integrated.

